



**MULTI-INNO TECHNOLOGY CO., LTD.**

[http:// www.multi-inno.com](http://www.multi-inno.com)

## **TOUCH PANEL SPECIFICATION**

**Model : MI0700CGP-C**

**Customer :**

Approved	
Commont	

Revision	1.0
Engineering	
Date	2012-12-08
Our Reference	





# CONTENTS

- GENERAL SPECIFICATIONS
- PRODUCTION DESCRIPTION
- CIRCUIT BLOCK DIAGRAM
- PIN CONNECTIONS
- RELIABILITY
- SPECIFICATION OF QUALITY ASSURANCE
- PRECAUTIONS FOR USE OF CTP MODULES
- OUTLINE DRAWING

## ■ GENERAL SPECIFICATIONS

The projected capacitive touch technology applied to this product is an ITO-based touch technology. It consists of one glass substrate layers with ITO coating patterned into a grid of rows/columns and cover lens that are laminated together. During a touch, the capacitance of the finger changes the capacitive coupling between the grid elements on the location of the touch. This location is calculated from the change in electrical characteristics of the sensor grid. Mathematical processing, programmed in the Touch Controller chip, is used to recognize this distortion. Capacitive sensors can be touched with a bare finger or a conductive device being held by a bare hand. They are not affected by outside elements and have high clarity.

The purpose of this specification is to define the general provisions and quality requirements that apply to the supply of capacitive touch sensor or capacitive touch panel (CTP) module manufactured by Multi-Inno. This document, together with the Module Drawing, is the highest-level specification for this product. It describes the product and contains specifications.

Features	Details	Unit	Note
Operation Technology	Projected capacitive	--	1
Product structure	Glass Lens—Glass Sensor	--	2
Input Method	Bare finger	--	--
Number of simultaneous touches	2 points multi-touch	--	--
Minimum Touch Area	Φ6	mm	--
Surface Treatment	--		
Finger Pitch	13mm		3
Connection Type	FPC,10pin, Pitch0.5,	--	—
Customer Application	Industry	--	--
CTP and LCD Assembly	DST	--	4
FG Weight	TBD	g	--

Note 1: Mutual mode.

Note 2: RoHS compatible.

Note 3: two points in a distance of 13 mm or above shall be recognized as two separate points

## ■ PRODUCTION DESCRIPTION

### 1 General description

Item	Contents	Unit	Note
Product size	7.0	inch	
TP outline	171.50 (W) x 110.30 (H) x 1.35(T)	mm	
TP active area	157.00(W) x 92.80(H)	mm	
Resolution	1024*600		
Operation temperature	-20~70	°C	
Storage temperature	-30~80	°C	
Control IC	NT11003QG-68/A		
Interface	I2C		1

Note 1: It can be compatible with Andriod 2.x.

### 2 Structure description

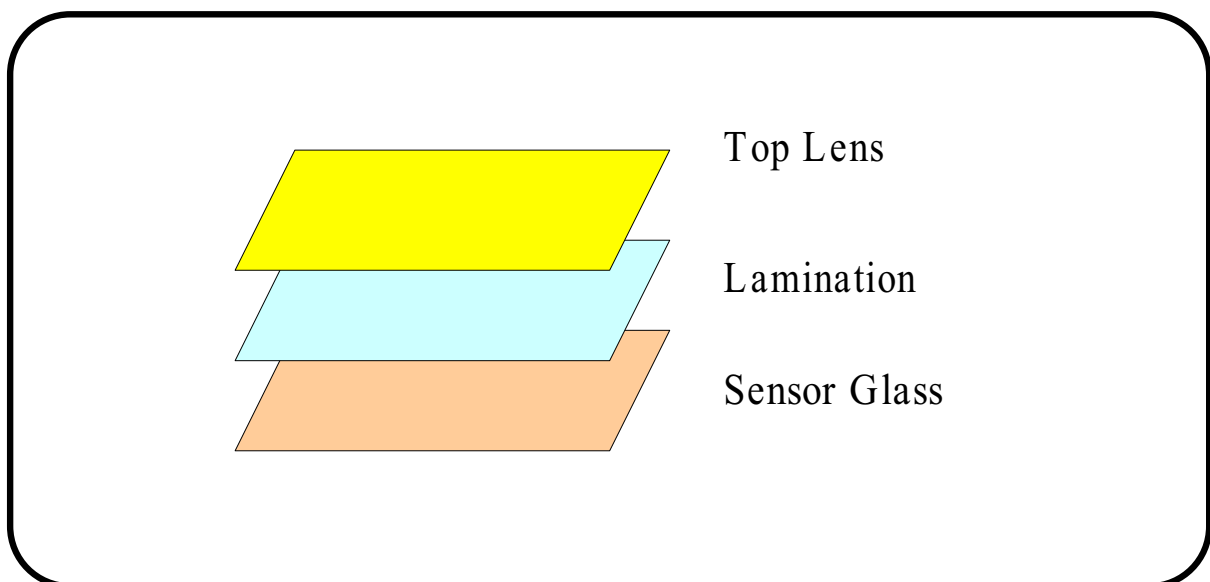

**Structure of touch panel**

### 3 DC Characteristics

( $T_A = 25^\circ\text{C}$ ,  $V_{DD} = 3.3\text{V}$ )

Item	Min	Typ	Max	Unit	Note
power supply voltage	--	3.3	--	V	DC(noise should be under 100mV)
Power supply current	--	6	10	mA	One finger on sensor
Sleep mode	--	--	60	uA	
Respond time	--	--	25	ms	

Note1: All current measurement is average current.

### 4 Interface Timing Chart

***Refer to NT11003\_QFN68 datasheet for details.***

### 5 Mechanical Characteristics

No.	Item	Requirement	Verification method
1	Surface hardness	6H	JIS-K5600
2	Drop ball test	No crack after test.	Use the 64g steel ( $\varnothing 25$ ) ball is dropped on the Glass surface from 70cm height at 1time(Glass side)
3	Surface pressure Test	No crack after test.	15 Kgf pressure in the center of the display using a rubber test head with a diameter of 15mm, 1 time, 1 minute, non-operation
4	Terminal Pull Test	Function is OK	$\pm 90^\circ$ direction, weight:500g, non-operation

### 6 Electrical Characteristics

condition ( $T_a = 25^\circ\text{C}$ ,  $V_{DD} = 3.3\text{V}$ )

No.	Item	Specification	NOTE
1	Linearity	$\pm 1.5$ mm	2mm at the border
2	Veracity	$\pm 1.5$ mm	2mm at the border
3	Sensivity	$\pm 1.5$ mm	2mm at the border
4	ESD	TBD	C=150pF、R=330 $\Omega$ Air= $\pm 8\text{KV}$ 5times; contact: $\pm 4\text{KV}$ 5times (Environment: $15^\circ\text{C} \sim 35^\circ\text{C}$ 、 30%~60%, 86Kpa~106Kpa)

## 7 Optical Characteristics (Ta = 25 °C)

No.	Item	Min.	Typ.	Max.	Unit	Remark
1	Transmission	86	88		%	Note 1
2	Reflectivity				%	Note 1,Note 2
3	HAZE				%	

Note1: Measuring equipments: DMS-501, PR-705. @550nm

Measuring condition:

- After stabilizing and leaving the panel alone at a given temperature for 30 min, the measurement should be executed,
- Measuring surroundings: a stable, windless and dark room,
- Measuring temperature: Ta=25°C,
- 30 min after lighting the back-light.

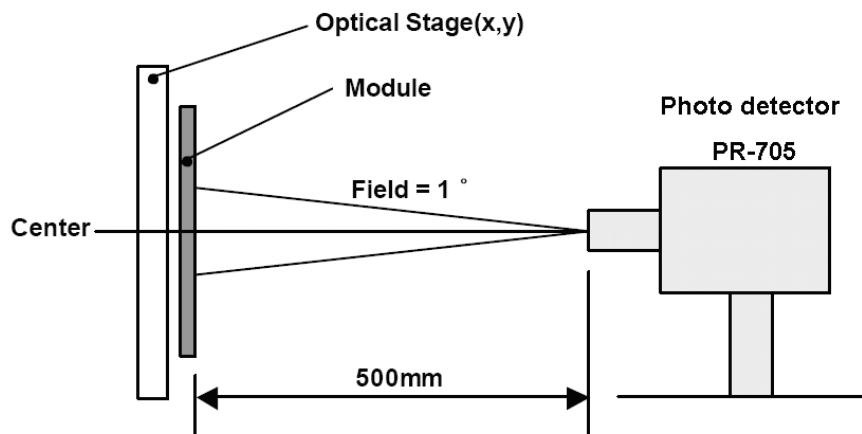

Note2: conform to National standard GB2410—80 /ASTM D1003—61(1997)

### ■ CIRCUIT BLOCK DIAGRAM

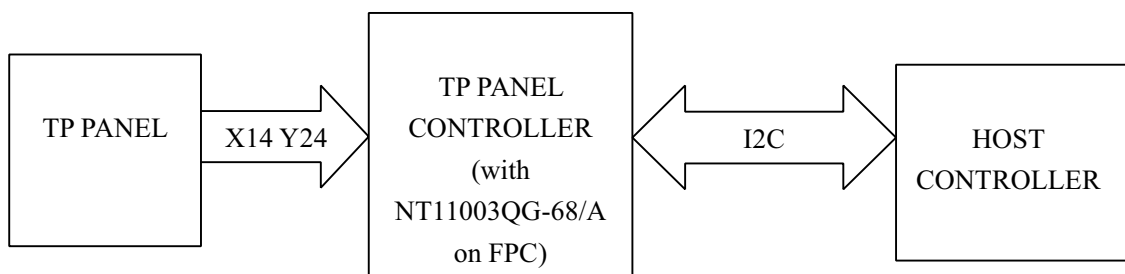

Fig2. System Block Diagram

## ■ PIN CONNECTIONS

Pin No.	Symbol	I/O	Description	Remark
1	SCL	P	I2C clock input	
2	SDA	I/O	I2C data input and output	
3	GND	P	Groud	
4	GND	P	Groud	
5	ATTN	I/O	External interrupt from the host	
6	GND	P	Groud	
7	VPP	I/O	External interrupt from the host	
8	VDD	P	CTP power supply	
9	GND	P	Groud	
10	GND	P	Groud	

## ■ RELIABILITY

No	Test Item	Test condition	Criterion
1	High Temperature Storage	+80°C±2°C Power off	
2	Low Temperature Storage	-30°C±2°C Power off	
3	High Temperature Operation	+70°C±2°C Power on	
4	Low Temperature Operation	-20°C±2°C Power on	
5	High Temperature & Humidity Storage	+60°C±2°C 90%RH±2%RH,	
6	Thermal Shock Test(storage)	-30°C (30min) ⇔ 80°C (30min) ,Change Time:5min	
7	Shock Test	Half Sine Wave 490m/s <sup>2</sup> ,6ms,±X,±Y,±Z 2times for each direction	
8	Vibration Test	5~10Hz、Amplitude 25mm 10~30Hz、 3.7×9.8m/s <sup>2</sup> X,Y,Z 30 ~ 50Hz 、 1.6×9.8m/s <sup>2</sup> 8min×2 、 sweep 50~80Hz、 0.7×9.8m/s <sup>2</sup> non-operation 80~100Hz、 0.3×9.8m/s <sup>2</sup>	
9	Package Drop Test	Height:60cm, 1corner,3edges,6surfaces	



10	Package Vibration Test	Half Sine Wave 50G 6ms, ±X,±Y,±Z 3times for each direction	
----	------------------------	--	--

Note: Additional test Item proposed by customer shall be determined by mutual agreement between customer and Multi-Inno

For consumer production uses, we recommended the temperature operation range of 0~60 degree, beyond this temperature range can still be used, but the performance may be decrease, the difference with the production will be different.

## ■ SPECIFICATION OF QUALITY ASSURANCE

### 1 Inspection condition

- a. Inspected Temperature: 20~25°C, Inspected Distance: 30±5cm.
- b. Viewing Angle:

When inspecting, keep the eyesight perpendicular to the product surface: 90± 30 degree, as below.

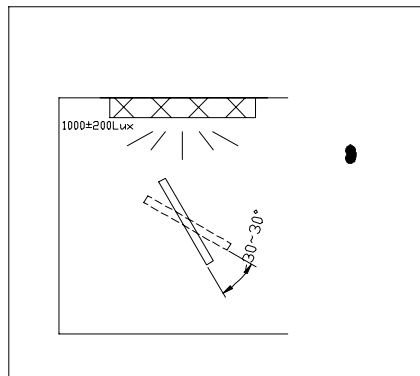

- c. Inspected illumination: 1000±200Lux.
- d. Inspected background: Under black background

### 2 Definiton for the appearance area.

A area: The front area of the sample and the transparent area from the backside; as below;

B area: The backside printing area. As below.

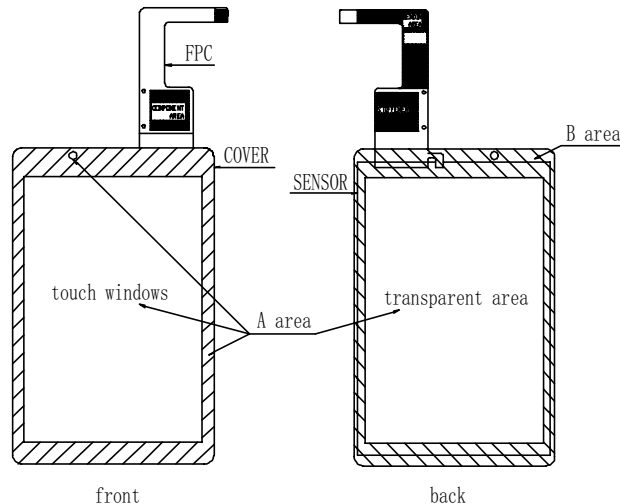

### 3 Definiton for the defects.

a. Circular Defects:

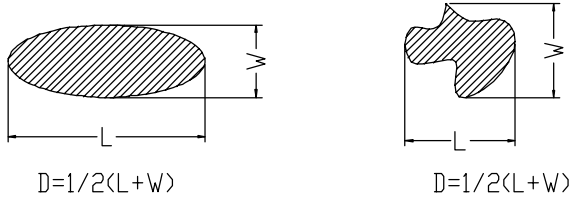

D: diameter W:width L: length (the same as below)

b. Linear Defects:

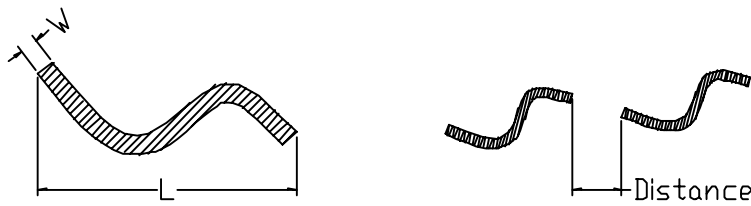

c. Pin hole(Translucidus)

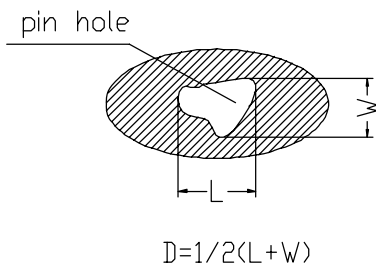

d. Zigzag for the printing ink

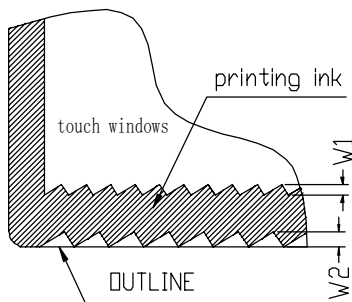

e. Edge Crack Chip

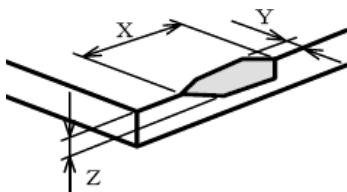

f. Corner Crack Chip

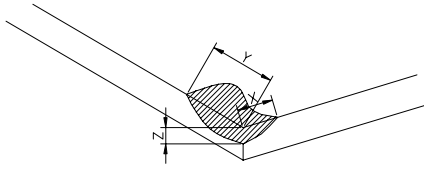

g. Bad Crack

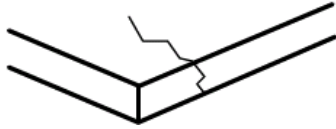

## 4 Foreign object

No.	Inspection items	Judgment standard(Unit: mm)		
		Defect Size	Judgment (A Area)	Judgment (B Area)
1	Circular Defects(Dot, Impurity, Dust, Bubble)	$D \leq 0.20$	Neglected(distance $\geq 10$ )	Neglected
		$0.20 \leq D \leq 0.3$	$N \leq 5$ , (distance $\geq 10$ )	
		$D > 0.3$	Not allowed	
		Notes: 1、 The circular defects which can be removed is ignored. 2、 The circular defects of B area should not affect to assembly,functionality or final look of the product. 3、 The circular defects of A area does not include the protective film, TThe circular defects of B area does not include the adhesive tapes.		
2	Linear Defects(Scratch Line\Foreign material )	W(width)/L(length)	Judgment	
		$W \leq 0.10, L \leq 3.0$	Neglected(distance $\geq 10$ )	
		$0.10 < W \leq 0.20, L \leq 3.0$	$N \leq 3$ , (distance $\geq 10$ )	
		$W > 0.2, L > 3.0$	Not allowed	
Notes: The foreign meterial which can be removed is ignored.				
3	Dent	Defect Size	Judgment (A Area)	Judgment (B Area)
		$D \leq 0.15$	Neglected(distance $\geq 10$ )	Neglected
		$0.15 \leq D \leq 0.3$	$N \leq 3$ , (distance $\geq 10$ )	
		$D > 0.3$	NG	
Notes: 1、 The foreign meterial which can be removed is ignored. 2、 The foreign meterial of B area should not affect to assembly,functionality or final look of the product.				

4	Dirt/Fingerprint/ Smokes/Snake/Rainbo w effect	A area: not allowed; B area: neglected (Not affect to assembly,functionality or final look of the product.)
5	Printing ink color	The printing ink color should be consistent with design drawing. (or client standard sample).
6	Printing ink color difference	1、 The judgement area is the front non-translucent zone of the sample. 2、 Accept the same series ink color printing shift. 3、 Color difference of IR hole,light sensor hole is not inspected. 4、 If there is customer's inspection criteria or sample,determining by customer's inspection criteria or standard sample.
7	Transmittance-rate ( IR hole\light sensor hole)	Meet design drawing.
8	Printing pin hole	Not allowed
9	Font / Logo	Font / Logo should be printed smooth, no jagged, shadow, penetration, wear and tear, displacement, disconnection and connection defects
10	Breakage on edge or corner	A area(front side): not allowed B area(back side): $X \leq 0.2, Y \leq 0.2, Z \leq 1/5T$ ; $N \leq 2$ , (distance $\geq 20$ ), Neglected
11	Crack	Not allowed
12	Printing ink Edges burrs / Printing ink Zigzag	1、 the front (back) printing ink edge of the touch window region : $W1 \leq 0.2$ , OK; $W1 > 0.2$ , NG。 2、 the front (back) printing ink edge of the sample: $W2 \leq 0.3$ , OK; $W2 > 0.3$ , NG。
13	Foreign material of printing area	(1).The touch windows + 0~2.0mm: the criteria is same to Circular Defects; (2). The touch windows + 2.0 ~ 5.0mm : $D \leq 0.3$ , Neglected(distance $\geq 5.0$ ) (3).The other areas: $D \leq 0.5$ , Neglected(distance $\geq 5.0$ )
14	Circular Defects for LED hole/ IR hole/sensor hole	Sensor hole、 LED hole: $D \leq 0.1\text{mm}$ , $N \leq 1$ , allowed ; $D > 0.1\text{mm}$ , not allowed; IR hole: $D \leq 0.1\text{mm}$ , neglected; $D > 0.1\text{mm}$ , not allowed。
15	Bad cutting section for cover/sensor	1.Cutting section allow the wave-like phenomenon, but the cutting edge level of view must be a smooth line; 2, cutting section does not allow any cracks appearance.

16	Surface Dirt	<p>1, the process dirt which can not wipe with alcohol is not allowed;</p> <p>2, The dirty can be wiped with a clean cloth or with clean cloth &amp; alcohol , and the dirt is less than 10% of the total area of the product, and the dirt is less than two points each piece of product, allowed.</p>
17	FPC	<p>1.The component soldering can not be cold soldering, short, open circuit, burrs, tin ball;</p> <p>2.The shape of FPC can not been broken, died off;</p> <p>3.FPC stiffener of the component area can not drain back paste or damaged;</p> <p>4.FPC version number should be consistent with the design drawing;</p>
18	Tape (foam / double-sided adhesive, etc.) Judgement	Tape attached should be consistent with the design drawing;, not missing , unbreakable, non-attached side.

**■ PRECAUTIONS FOR USE OF CTP MODULES**

**1 Mounting Precaution**

1.1 Beze Mounting

When mounting the CTP underneath a bezel,the CTP assembly should be mounted using a configuration that supports the back surface of the TFT module.The bezel edge must be positioned outside the active area of the CTP.A gap of 0.5mm to 1.0mm is needed between the bezel and the CTP surface.A foam gasket or similar material should be used to compensate for the tolerance of the enclosure,compression for the screw,etc.

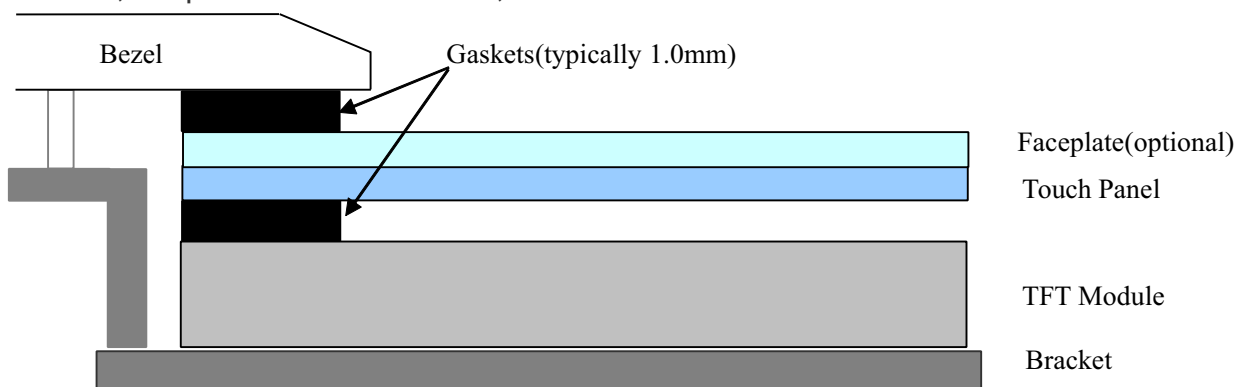

## 1.2 Flush Mounting

When flush mounting the faceplate with the top of the enclosure, the enclosure must have a ledge for attaching the overhang of the faceplate as well as a ledge for supporting the back of the TFT module.

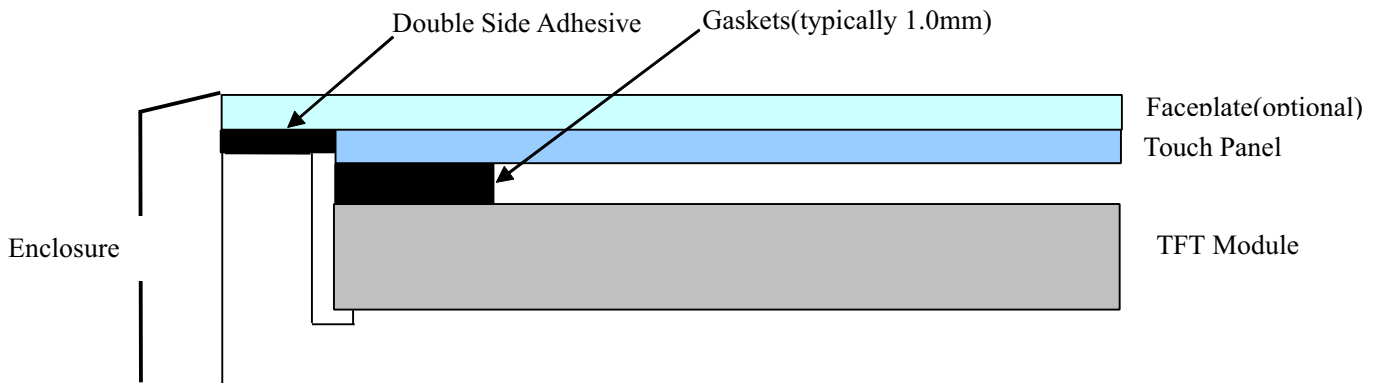

## 1.3 Optical Bonding

The airgap between the TFT and CTP can be eliminated by using an optical bonding. Elimination of the air gap improves the electrical performance of the CTP and enhances the clarity of the TFT image.

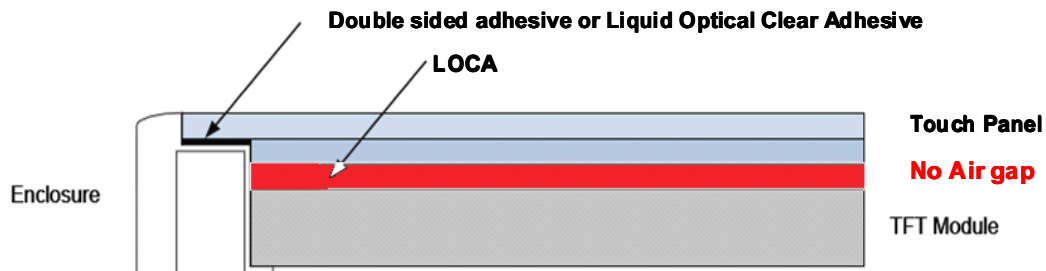

## 2 Handling Precautions

- 2.1 The product is made of glass. Do not subject it to a mechanical shock by dropping it from a high place, etc.
- 2.2 Do not apply excessive force to the product since this may damage to the performance;
- 2.3 If the display surface is contaminated, breathe on the surface and gently wipe it with a soft dry cloth. If still not completely clear, moisten cloth with one of the following solvents:

- Isopropyl alcohol
- Ethyl alcohol

Solvents other than those mentioned above may damage the product. Especially, do not use the following:

- Water
- Ketone
- Aromatic solvents



- 
- 2.4 Do not attempt to disassemble the CTP Module.
  - 2.5 If the logic circuit power is off, do not apply the input signals.
  - 2.6 To prevent destruction of the elements by static electricity, be careful to maintain an optimum work environment.
    - a. Be sure to ground the body when handling the CTP Modules.
    - b. Tools required for assembly, such as soldering irons, must be properly ground.
    - c. To reduce the amount of static electricity generated, do not conduct assembly and other work under dry conditions.
    - d. The CTP Module is coated with a film to protect the display surface. Be care when peeling off this protective film since static electricity may be generated.

### 3 Storage precautions

- 3.1 When storing the CTP modules, avoid exposure to direct sunlight or to the light of fluorescent lamps.
- 3.2 The CTP modules should be stored under the storage temperature range. If the CTP modules will be stored for a long time, the recommend condition is:  
Temperature :  $0^{\circ}\text{C} \sim 40^{\circ}\text{C}$   
Relatively humidity:  $\leq 80\%$
- 3.3 The LCD modules should be stored in the room without acid, alkali and harmful gas.

### 4 notes

The CTP modules should be no falling and violent shocking during transportation, and also should avoid excessive press, water, damp and sunshine.



■ OUTLINE DRAWING

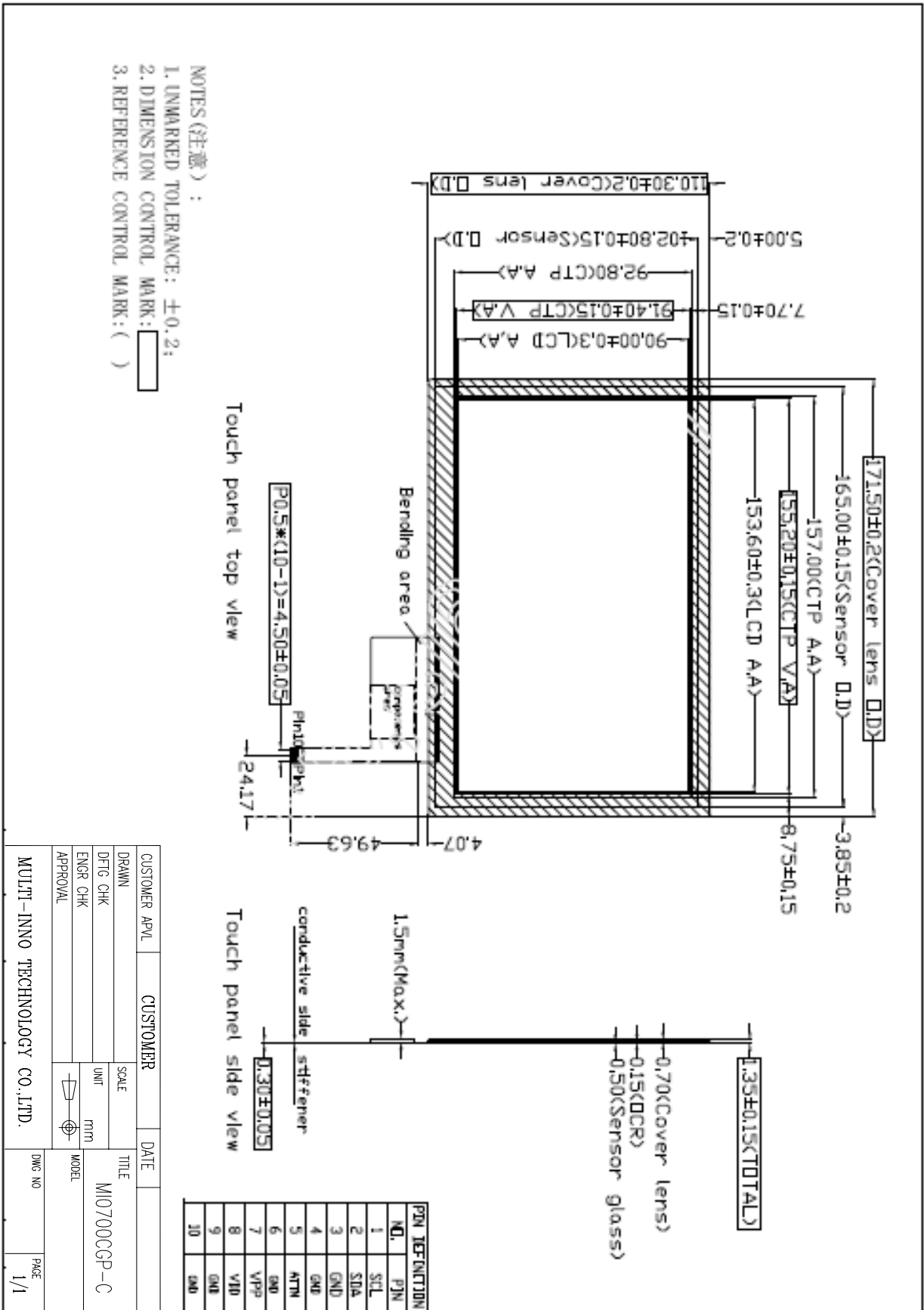

CUSTOMER APPL	CUSTOMER	DATE	
DRAWN	SCALE	TITLE	
DFTG CHK	UNIT	MM	MI0700CGP-C
ENGR CHK	MODEL		
APPROVAL			
MULTI-INNO TECHNOLOGY CO.,LTD.			DWG NO
			PAGE
			1/1