

**DOT MATRIX
LIQUID CRYSTAL DISPLAY
MODULE**

HTM2002A Serial

USER' MANUAL

| | | | |
|--|--|--|--|
| | | | |
| | | | |
| | | | |
| | | | |

| PROPOSED BY | | APPROVED |
|--------------------|----------|-----------------|
| Design | Approved | |
| | | |

CONTENTS

| | PAGE |
|--|-------------|
| 1. Mechanical Specification | 2 |
| 2 Mechanical Diagram | 2 |
| 3. Interface Pin Connections | 2 |
| 4. Block Diagram | 2 |
| 5. Absolute Maximum Rating | 3 |
| 6. Electrical Characteristics | 3 |
| 7. Optical Characteristics | 3 |
| 8. Optical Definitions | 3 |
| 9. Display Address | 3 |
| 10. Interface to MPU | 4 |
| 10.1 Interface to Z-80 CPU | 4 |
| 10.2 Interface to MC6800 CPU | 4 |
| 10.3 Interface to 4-bit CPU (HMCS43C) | 4 |
| 10.4 Interface to HD6805 MP | 4 |
| 11. Timing Control | 4 |
| 11.1 Write and Read Operation | 4 |
| 11.2 Busy flag check timing | 4 |
| 12. Initialization of LCM | 5 |
| 13. Instruction Set | 6 |
| 14. User Font Patterns | 6 |
| 15. Software Example | 7 |
| 15.1 8-bit operation (8 bits 2 lines) | 7 |
| 15.2 4-bit operation (4 bits 2 lines) | 7 |
| 16. Reliability Condition | 8 |
| 17. Function Test & Inspection Criteria | 8 |
| 18. Character Generator ROM Map(Standard) | 10 |
| 19. Character Generator ROM Map (Russian) | 11 |

1. Mechanical Specification

| ITEM | STANDARD VALUE | | | UNIT |
|--------------------------|----------------------------------|---|-----|------|
| NUMBER OF CHARACTERS | 20CHARACTERS x 2 LINES | | | -- |
| CHARACTER FORMAT | 5 x 8 DOTS | | | -- |
| MODULE DIMENSION | 116.0 (W) x 37.0 (H) x 14.6 MAX. | | | mm |
| VIEWING DISPLAY AREA | 83.0 (W) x 18.6 (H) | | | mm |
| ACTIVE DISPLAY AREA | 75.4 (W) x 11.5 (H) | | | mm |
| CHARACTER SIZE | 3.2 (W) x 5.5 (H) | | | mm |
| CHARACTER PITCH | 3.8 (W) x 5.95 (H) | | | mm |
| DOT SIZE | 0.6 (W) x 0.65 (H) | | | mm |
| DOT PITCH | 0.65 (W) x 0.7 (H) | | | mm |
| LCD DISPLAY TYPE | STN-YG, POSITIVE, Transflective | | | |
| OPERATING TEMPERATURE | -20°C ~ +70°C | | | |
| STORAGE TEMPERATURE | -30°C ~ +80°C | | | |
| LED Backlight Color | Yellow Green | | | |
| Backlight Input | DC +4.1V | V | 140 | mA |
| Backlight Half-Lift Time | 50,000 | | | HR. |

2. Mechanical Diagram

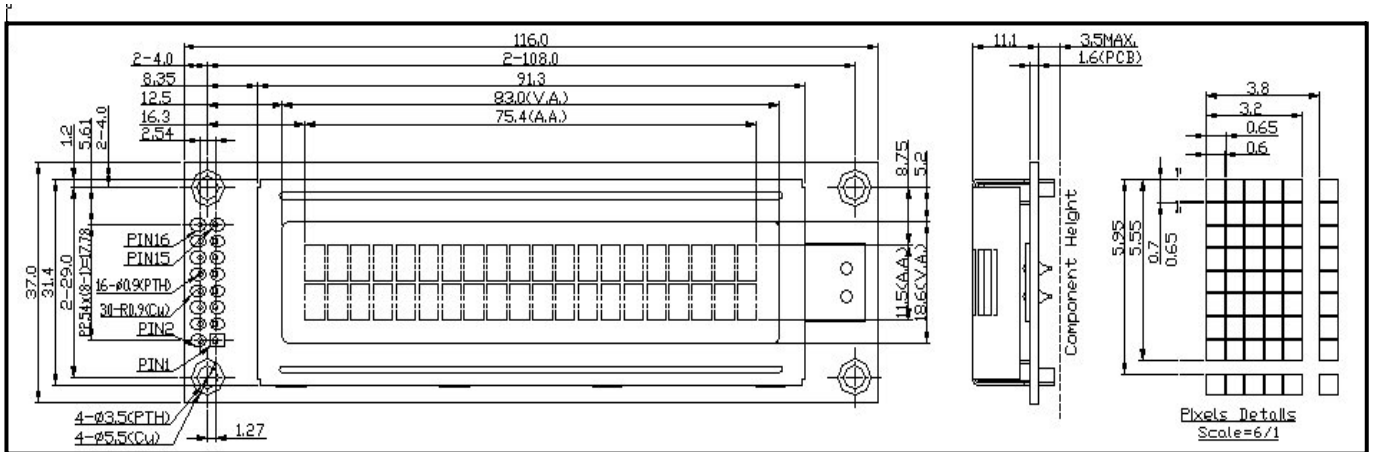

3. Interface Pin Connections

| NO | SYMBOL | LEVEL | FUNCTION |
|----|--------|-------|-----------------|
| 1 | VSS | -- | GND (0V) |
| 2 | VDD | H/L | DC +5V |
| 3 | V0 | H/L | Contrast Adjust |
| 4 | RS | H/L | Register select |
| 5 | R/W | H/L | Read/Write |
| 6 | E | H,H→L | Enable signal |
| 7 | DB0 | H/L | Data Bit 0 |
| 8 | DB1 | H/L | Data Bit 1 |
| 9 | DB2 | H/L | Data Bit 2 |
| 10 | DB3 | H/L | Data Bit 3 |
| 11 | DB4 | H/L | Data Bit 4 |
| 12 | DB5 | H/L | Data Bit 5 |
| 13 | DB6 | H/L | Data Bit 6 |
| 14 | DB7 | H/L | Data Bit 7 |
| 15 | BLA | -- | BL+ |
| 16 | BLK | -- | BL- |

4. Block Diagram

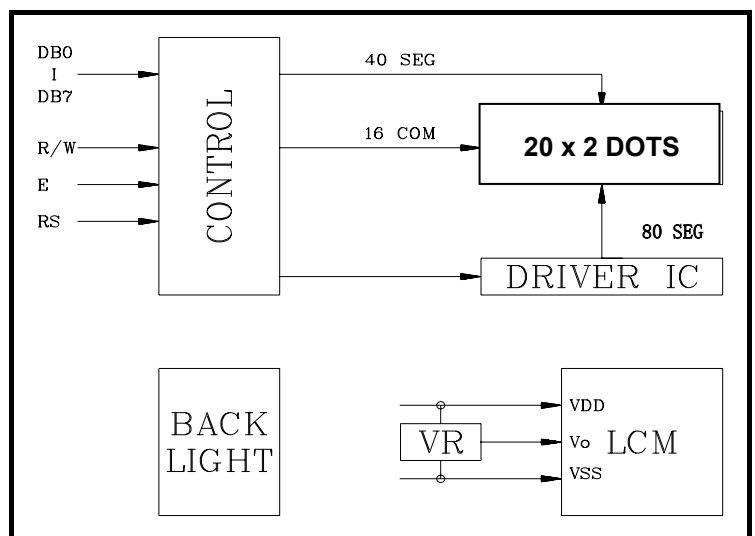

5. Absolute Maximum Ratings

| ITEM | SYMBOL | MIN. | TYPE | MAX. | UNIT |
|--------------------------|--|------|------|------|------|
| OPERATING TEMPERATURE | TOP | -20 | -- | +70 | °C |
| STORAGE TEMPERATURE | TST | -30 | -- | +80 | °C |
| INPUT VOLTAGE | VI | VSS | -- | VDD | V |
| SUPPLY VOLTAGE FOR LOGIC | VDD-VSS | -- | 5.0 | 6.5 | V |
| SUPPLY VOLTAGE FOR LCD | VDD-VO | -- | -- | 6.5 | V |
| STATIC ELECTRICITY | Be sure that you are grounded when handling LCM. | | | | |

6. Electrical Characteristics

| ITEM | SYN | CONDITION | MIN. | TYPE | MAX. | UNIT |
|--------------------------|---------|----------------|------|---------|------|------|
| SUPPLY VOLTAGE FOR LOGIC | VDD-VSS | -- | 4.5 | 5.0 | 5.5 | V |
| SUPPLY VOLTAGE FOR LCD | VDD-VO | Ta= 0/-20 °C | -- | 4.8/5.0 | -- | V |
| | | Ta= 25°C | -- | 4.4 | -- | V |
| | | Ta= +50/+70 °C | -- | 4.1/3.9 | -- | V |
| INPUT HIGH VOLTAGE | VIH | -- | 2.2 | -- | VDD | V |
| INPUT LOW VOLTAGE | VIL | -- | 0 | -- | 0.6 | V |
| OUTPUT HIGH VOLTAGE | VOH | -- | 2.4 | -- | -- | V |
| OUTPUT LOW VOLTAGE | VOL | -- | -- | -- | 0.4 | V |
| SUPPLY CURRENT | IDD | VDD=+5V | -- | 3.0 | 4.5 | mA |

7. Optical Characteristics

| ITEM | SYM | CONDITION | MIN. | TYPE | MAX. | UNIT |
|----------------|-----------|-------------|------|------|------|------|
| VIEW ANGLE (V) | θ | CR \geq 2 | -10 | -- | 40 | deg. |
| VIEW ANGLE (H) | φ | CR \geq 2 | -30 | -- | 30 | deg. |
| CONTRAST RATIO | CR | -- | -- | 5 | -- | -- |
| RESPONSE TIME | TON | -- | -- | 180 | 230 | mS |
| RESPONSE TIME | TOFF | -- | -- | 100 | 150 | mS |

8. Optical Definitions

Response Time

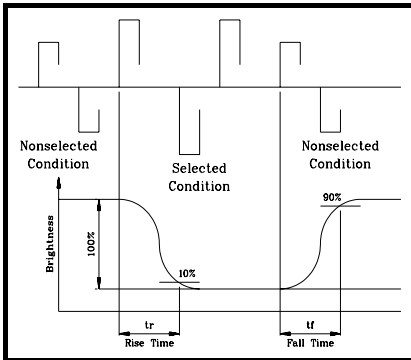

Contrast Ratio

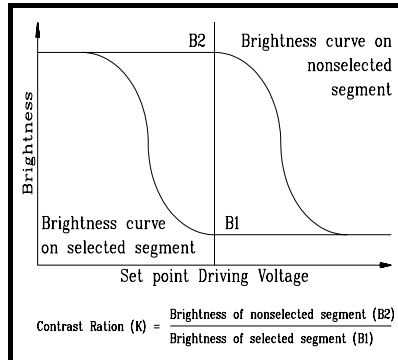

View Angle

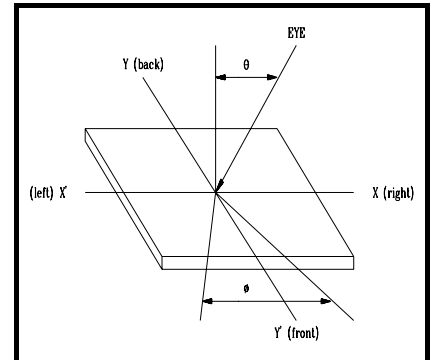

9. Display Address

| | 1 | 2 | 3 | 4 | 5 | 6 | 7 | 8 | 9 | 10 | 11 | 12 | 13 | 14 | 15 | 16 | 17 | 18 | 19 | 20 |
|--------|----|----|----|----|----|----|----|----|----|----|----|----|----|----|----|----|----|----|----|----|
| Line 1 | 80 | 81 | 82 | 83 | 84 | 85 | 86 | 87 | 88 | 89 | 8A | 8B | 8C | 8D | 8E | 8F | 90 | 91 | 92 | 93 |
| Line 2 | C0 | C1 | C2 | C3 | C4 | C5 | C6 | C7 | C8 | C9 | CA | CB | CC | CD | CE | CF | D0 | D1 | D2 | D3 |
| Line 3 | | | | | | | | | | | | | | | | | | | | |
| Line 4 | | | | | | | | | | | | | | | | | | | | |

| | 21 | 22 | 23 | 24 | 25 | 26 | 27 | 28 | 29 | 30 | 31 | 32 | 33 | 34 | 35 | 36 | 37 | 38 | 39 | 40 |
|--------|----|----|----|----|----|----|----|----|----|----|----|----|----|----|----|----|----|----|----|----|
| Line 1 | | | | | | | | | | | | | | | | | | | | |
| Line 2 | | | | | | | | | | | | | | | | | | | | |
| Line 3 | | | | | | | | | | | | | | | | | | | | |
| Line 4 | | | | | | | | | | | | | | | | | | | | |

10. Interface to MPU

10.1 Interface to Z-80 CPU

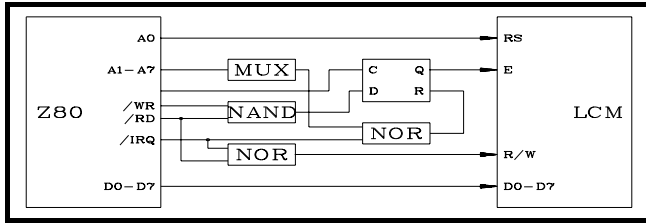

10.2 Interface to MC6800 CPU

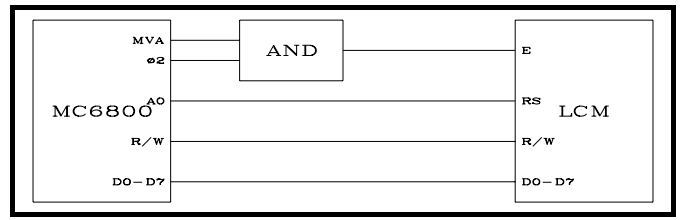

10.3 Interface to 4-bit CPU (HMCS43C)

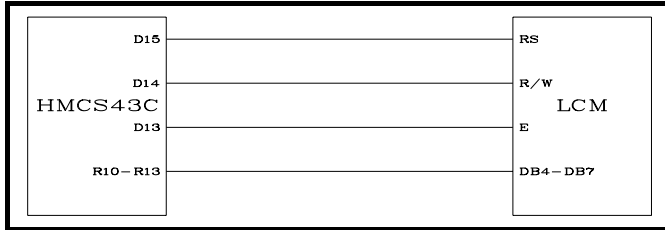

10.4 Interface to HD6805 MP

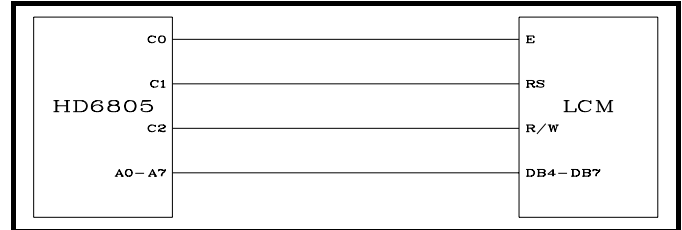

11. Timing Control

11.1 Write and Read Operation

Write Operation

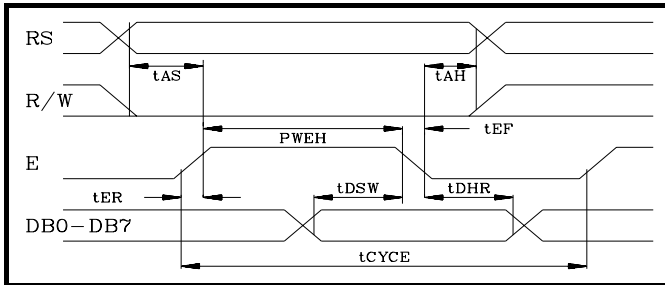

Read Operation

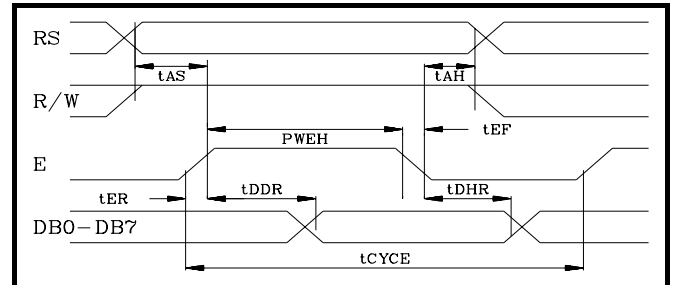

| Item | Symbol | Limit (Min.) | Limit (Max.) | Unit |
|-----------------------------------|---------|--------------|--------------|------|
| Enable Cycle Time | tCYCE | 1000 | -- | ns |
| Enable Pules Width (High level) | PWEH | 450 | -- | ns |
| Enable Rise/Fall Time | tER,tEF | -- | 25 | ns |
| Address Set-Up Time (RS,R/W,E) | tAS | 100 | -- | ns |
| Address Hole Time | tAH | 10 | -- | ns |
| Data Set-Up Time | tDSW | 100 | -- | ns |
| Data Delay Time | tDDR | -- | 190 | ns |
| Data Hold Time | tDHR | 20 | -- | ns |

11.2 Busy flag check timing

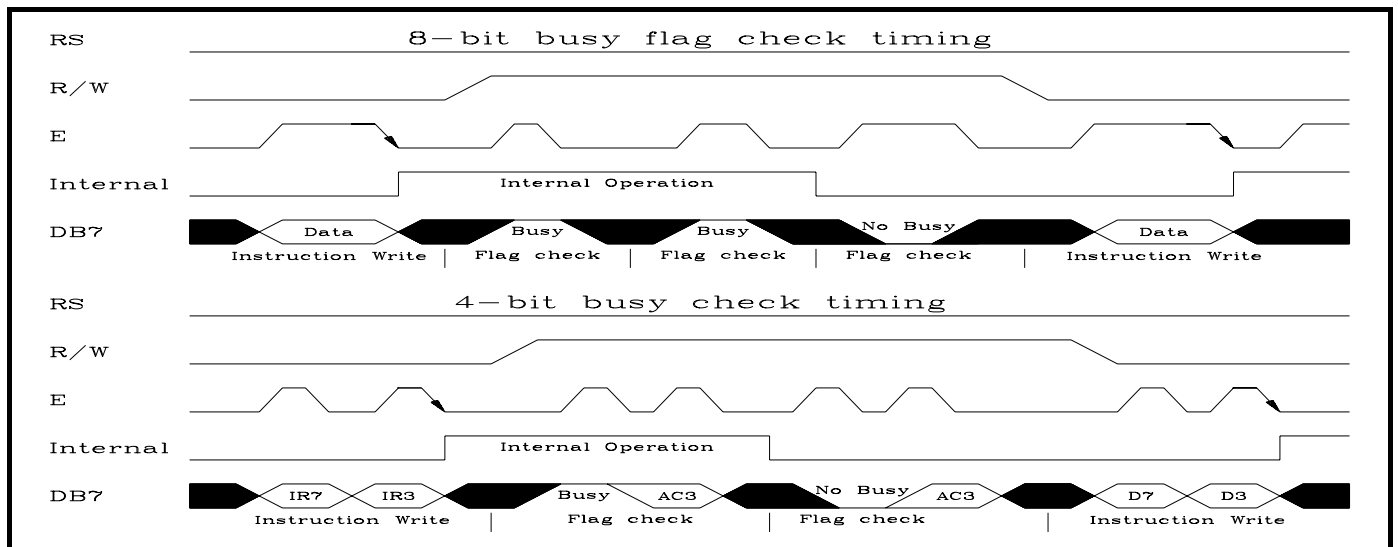

Note : IR7, IR3 : Instruction 7th bit , 3rd bit ; AC3 : Address Counter 3rd bit.

12. Initialization of LCM

The LCM automatically initializes (reset) when power is turned on using the internal reset circuit. If the power supply conditions for correctly operating of the internal reset circuit are not met, initialization by instruction is required. Use the procedure is next page for initialization.

Internal Power Supply reset

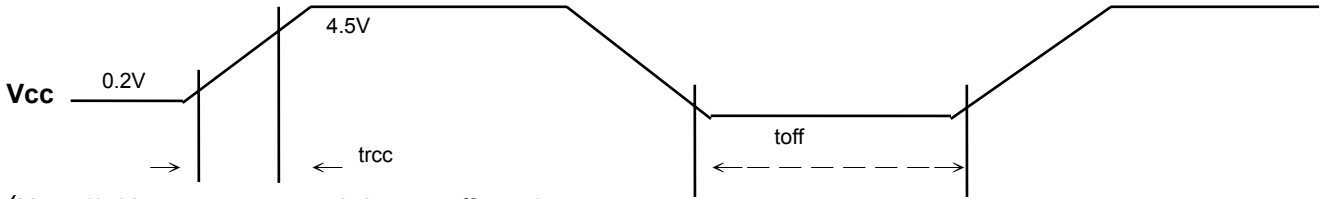

(Note 1) $10\text{ ms} \geq tr_{cc} \geq 0.1\text{ ms}$, $to_{ff} \geq 1\text{ ms}$.

(Note 2) to_{ff} stipulates the time of power OFF for momentary power supply dip or when power supply cycles ON and OFF.

| Item | Symbol | Test condition | Limit (Min.) | Limit (Max.) | Unit |
|------------------------|-----------|----------------|--------------|--------------|------|
| Power supply rise time | tr_{cc} | -- | 0.1 | 10 | ms |
| Power supply off time | to_{ff} | -- | 1 | -- | ms |

1) 8 Bit Interface

2) 4 Bit Interface

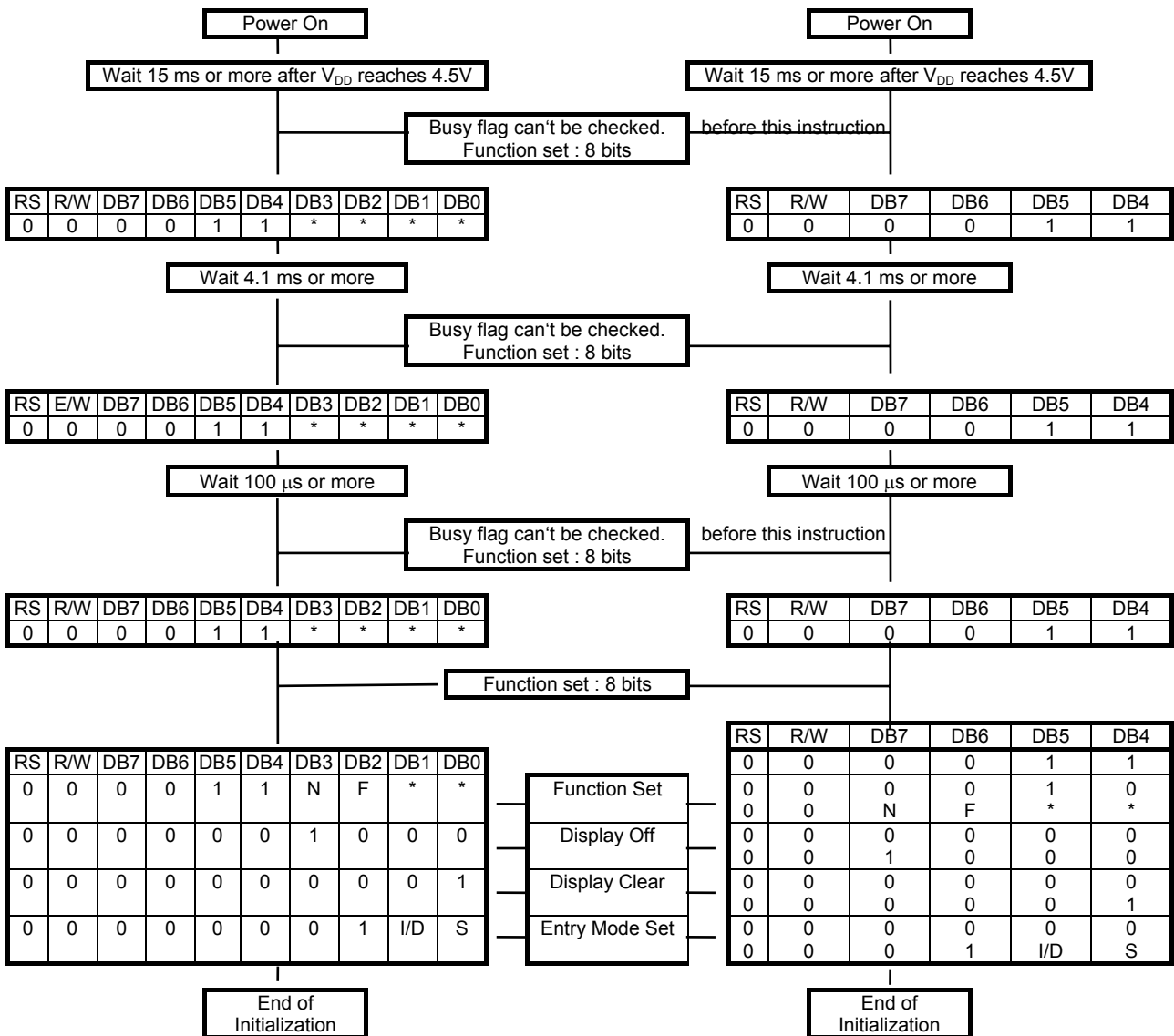

- Busy flag is checked after instructions are completed. If busy flag isn't checked, the waiting time between instructions should be longer than execution time of these instructions.

13. Instruction Set

| FUNCTION | R S | R /W | D B 7 | D B 6 | D B 5 | D B 4 | D B 3 | D B 2 | D B 1 | D B 0 | DESCRIPTION | EXECU. TIME* (MAX.) |
|--------------------------|--------|---------|-------------|-------------|-------------|-------------|-------------|-----------------------------------|---|--|--|---------------------------|
| Clear Display | 0 | 0 | 0 | 0 | 0 | 0 | 0 | 0 | 0 | 1 | Clears entire display and returns the cursor to home position (address 0). | 1.64ms |
| Return Home | 0 | 0 | 0 | 0 | 0 | 0 | 0 | 0 | 1 | x | Return the cursor to the home position. Also returns the display being shifted to the original position. DD RAM contents remain unchanged. | 1.64ms |
| Entry mode set | 0 | 0 | 0 | 0 | 0 | 0 | 0 | 1 | I / D | S | Set cursor move direct and specifies display shift. These operations are performed during data rite/read. For normal operation, set S to zero. I/D=1 : increment ; 0 :decrement ; S=1 : accompanies display shift when data is written, for normal operation, set to zero. | 40 μs |
| Display ON/OFF control | 0 | 0 | 0 | 0 | 0 | 0 | 1 | D | C | B | Set ON/OFF all display(D),cursor ON/OFF(C), and blink of cursor position character(B). D=1: ON display; 0:OFF display. C=1: ON cursor;0: OFF cursor. B=1: ON blink cursor; 0: OFF blink cursor. | 40 μs |
| Cursor or Display shift | 0 | 0 | 0 | 0 | 0 | 1 | S / C | R / L | x | x | Move the cursor and shift the display without changing DD RAM contents. S/C=1: Display shift; 0:Cursor move. R/L=1: shift to right; 0: shift to left. | 40 μs |
| Function Set | 0 | 0 | 0 | 0 | 1 | D L | N | F | x | x | Set the interface data length (DL). Number of display lines (N) and character font (F). DL=1: 8 bits; 0:4 bits. N=1: 2 lines; 0: 1 lines. F=1: 5x10 dots; 0: 5x7 dots. | 40 μs |
| Set CG RAM address | 0 | 0 | 0 | 1 | ACG | | | | | Set CG RAM address. CG RAM data is sent and received after this setting. | 40 μs | |
| Set DD RAM address | 0 | 0 | 1 | ADD | | | | | Set DD RAM address. DD RAM data is sent and received after this setting | 40 μs | | |
| Read busy flag & address | 0 | 1 | B F | AC | | | | | Reads Busy Flag (BF) indicating internal operation is being performed and reads address counter contents. BF=1: internally operating. 0: can accept instruction | 1 μs | | |
| Write Data to CG/DDRAM | 1 | 0 | WRITE DATA | | | | | Write data into DD RAM or CG RAM. | 40 μs | | | |
| Read Data for CG/DDRAM | 1 | 1 | READ DATA | | | | | Read data from DD RAM or CG RAM | 40 μs | | | |

14. User Font Patterns (CG RAM Character)

| Character Code (DD RAM data) | | | CG RAM Address | | | Character Pattern (CG RAM data) | | | | | | |
|------------------------------|-----------------|----|----------------|-------|-----|---------------------------------|-----------|----|---|---|--|--|
| Hi | 7 6 5 4 3 2 1 0 | Lo | 5 4 3 | 2 1 0 | Hi | 7 6 5 | 4 3 2 1 0 | Lo | | | | |
| 0000x000 | | | 000 | 000 | xxx | 1 | 1 | 1 | 1 | 0 | | |
| | | | | 001 | xxx | 1 | 0 | 0 | 0 | 1 | | |
| | | | | 010 | xxx | 1 | 0 | 0 | 0 | 1 | | |
| | | | | 011 | xxx | 1 | 1 | 1 | 1 | 0 | | |
| | | | | 100 | xxx | 1 | 0 | 1 | 0 | 0 | | |
| | | | | 101 | xxx | 1 | 0 | 0 | 1 | 0 | | |
| | | | | 110 | xxx | 1 | 0 | 0 | 0 | 1 | | |
| | | | | 111 | xxx | 0 | 0 | 0 | 0 | 0 | | |
| 0000x001 | | | 001 | 000 | xxx | 1 | 0 | 0 | 0 | 1 | | |
| | | | | 001 | xxx | 0 | 1 | 0 | 1 | 0 | | |
| | | | | 010 | xxx | 1 | 1 | 1 | 1 | 1 | | |
| | | | | 011 | xxx | 0 | 0 | 1 | 0 | 0 | | |
| | | | | 100 | xxx | 1 | 1 | 1 | 1 | 1 | | |
| | | | | 101 | xxx | 0 | 0 | 1 | 1 | 0 | | |
| | | | | 110 | xxx | 0 | 0 | 1 | 0 | 0 | | |
| | | | | 111 | xxx | 0 | 0 | 0 | 0 | 0 | | |
| 0000x111 | | | 111 | 000 | | | | | | | | |
| | | | | 001 | | | | | | | | |
| | | | | 010 | | | | | | | | |
| | | | | 011 | | | | | | | | |
| | | | | 100 | | | | | | | | |
| | | | | 101 | | | | | | | | |
| | | | | 110 | | | | | | | | |
| | | | | 111 | | | | | | | | |

15. Software Example

15.1 8-bit operation (8 bits 2 lines)

| Function | R S | R w | D 7 | D 6 | D 5 | D 4 | D 3 | D 2 | D 1 | D 0 | Display | Description |
|-------------------------|--------|--------|--------|--------|--------|--------|--------|--------|--------|--------|--------------------|---|
| Power on delay | | | | | | | | | | | | Initialization. No display appears. |
| Function set | 0 | 0 | 0 | 0 | 1 | 1 | 0 | 0 | x | x | | Sets to 8-bit operation and selects 2-line display and 5x7 dots character font. (Note: number of display lines and character fonts cannot be changed after this.) |
| Display OFF | 0 | 0 | 0 | 0 | 0 | 0 | 1 | 0 | 0 | 0 | | Turn off display. |
| Display ON | 0 | 0 | 0 | 0 | 0 | 0 | 1 | 1 | 1 | 0 | - | Turn on display and cursor |
| Entry Mode Set | 0 | 0 | 0 | 0 | 0 | 0 | 0 | 1 | 1 | 0 | - | Set mode to increment the address by one and to shift the cursor to the right, at the time of write, to the DD/CG RAM Display is not shifted. |
| Write data to CG/DD RAM | 1 | 0 | 0 | 1 | 0 | 1 | 0 | 0 | 1 | 1 | S_ | Write "S". Cursor incremented by one and shift to right. |
| Write data to CG/DD RAM | 1 | 0 | 0 | 1 | 0 | 0 | 0 | 1 | 0 | 0 | SDEC_ | Write "D", "E", and "C". |
| Set DD RAM | 0 | 0 | 1 | 1 | 0 | 0 | 0 | 0 | 0 | 0 | SDEC | Set RAM address so that the cursor is positioned at the head of the second line. |
| Write data to CG/DD RAM | | | | * | | | | | | | SDEC CR_ | Write "C", and "R". |
| Cursor or display shift | 0 | 0 | 0 | 0 | 0 | 1 | 0 | 0 | x | x | SDEC CR | Shift only the cursor position to the left. |
| Write data to CG/DD RAM | | | | * | | | | | | | SDEC CO., LTD._ | Write "O., LTD." . |
| Entry Mode Set | 0 | 0 | 0 | 0 | 0 | 0 | 0 | 1 | 1 | 1 | SDEC CO., LTD._ | Set display mode shift at the time during writing operation. |
| Write data to CG/DD RAM | 1 | 0 | 0 | 1 | 1 | 1 | 1 | 0 | 0 | 0 | DEC O., LTD. x_ | Write " x". Cursor incremented by one and shift to right. (The display move to left.) |
| Write data to CG/DD RAM | | | | * | | | | | | | | Write other characters. |
| Return Home | 0 | 0 | 0 | 0 | 0 | 0 | 0 | 0 | 1 | 0 | SDEC CO., LTD. | Return both display and cursor to the original position (Set address to zero). |

15.2 4-bit operation (4-bit, 1 line)

| Function | RS | R/ W | D7 | D6 | D5 | D4 | Display | Description |
|-------------------------|----|---------|----|----|----|----|---------|---|
| power on delay | | | | | | | | initialization. No display appears. |
| Function set | 0 | 0 | 0 | 0 | 1 | 0 | | Sets to 4-bit operation. In this case, operation is handled as 8-bits by initialization, and only this instruction completes with one write. |
| Function set | 0 | 0 | 0 | 0 | 1 | 0 | | Sets 4-bit operation and selects 1-line display and 5x7 dot character font on and resetting is needed. (number of display lines and character fonts cannot be changed hence after). |
| Display ON/OFF Control | 0 | 0 | 0 | 0 | 0 | 0 | - | Turn on display and cursor. |
| Entry Mode Set | 0 | 0 | 0 | 0 | 0 | 0 | - | Set mode to incremented the address by one and to shift the cursor to the right, at the time of write. to the DD/CG RAM display is not shifted. |
| Write data to CG/DD RAM | 1 | 0 | 0 | 1 | 0 | 1 | S_ | Write "S". Cursor incremented by one and shift to right. |
| | 1 | 0 | 0 | 0 | 1 | 1 | | same as 8-bit operation |

16. Reliability Condition

| | | TN Type | | STN Type | | |
|----------------------------------|------------------------|-------------------------|-------------------------|-------------------------|-------------------------|-------------|
| | | Normal Temp. | Wide Temp. | Normal Temp. | Wide Temp. | |
| Viewing Angle | Horizontal Φ | $\pm 30^\circ$ | $\pm 30^\circ$ | $\pm 30^\circ$ | $\pm 30^\circ$ | |
| | Vertical Θ (mm) | 10° to 30° | 10° to 30° | -10° to 40° | -10° to 40° | |
| Operating Temperature | | -10 to 70°C | -25 to 80°C | 0 to 50°C | *-20 to 70°C | |
| Storage Temperature | | -20 to 80°C | -35 to 90°C | -20 to 70°C | *-30 to 80°C | |
| High Temperature (Power Off) | | 240 Hours @70°C | 240 Hours @90°C | 240 Hours @65°C | 240 Hours @75°C | |
| Low Temperature (Power Off) | | 240 Hours @-20°C | 240 Hours @-35°C | 240 Hours @-15°C | 240 Hours @-25°C | |
| High Temperature (Power On) | | 240 Hours @70°C | 240 Hours @80°C | 240 Hours @60°C | 240 Hours @70°C | |
| Low Temperature (Power On) | | 240 Hours @-10°C | 240 Hours @-25°C | 240 Hours @-10°C | 240 Hours @-20°C | |
| High Temperature & High Humidity | | 55°C/90%RH 240 Hours | 75°C/90%RH 240 Hours | 45°C/90%RH 240 Hours | 65°C/90%RH 240 Hours | |
| Thermal Shock 5 Cycle | | A | 60min@-20°C | 60min@-35°C | 60min@-20°C | 60min@-30°C |
| | | B | 5min@25°C | 5min@25°C | 5min@25°C | 5min@25°C |
| | | C | 60min@70°C | 60min@90°C | 60min@70°C | 60min@80°C |
| Expected Lift | | 50,000 Hours | 50,000 Hours | 50,000 Hours | 50,000 Hours | |

Wide temp. version may not available for some products, Please consult our sales engineer or representative.

17. Functional Test & Inspection Criteria

17.1 Sample plan

Sample plan according to MIL-STD-105D level 2, and acceptance/rejection criteria is.

Base on : Major defect : AQL 0.65 Minor defect : AQL 2.5

17.2 Inspection condition

Viewing distance for cosmetic inspection is 30cm with bare eyes, and under an environment of 800 lus (20W) light intensity. All direction for inspecting the sample should be within 45° against perpendicular line.

17.3 Definition of Inspection Zone in LCD

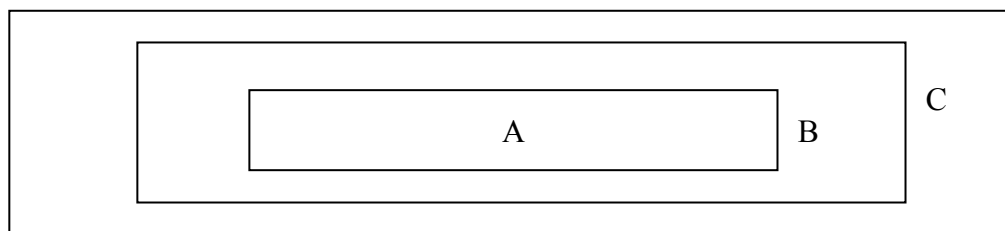

Zone A : Character / Digit area

Zone B : Viewing area except Zone A (Zone A + Zone B = minimum Viewing area)

Zone C : Outside viewing area (invisible area after assembly in customer's product)

Note : As a general rule, visual defects in Zone C are permissible, when it is no trouble for quality and assembly of customer's product.

17.4 Major Defect

All functional defects such as open (or missing segment), short, contrast differential, excess power consumption, smearing, leakage, etc. and overall outline dimension beyond the drawing. Are classified as major defects.

17.5 Minor Defect

Except the Major defects above, all cosmetic defects are classified as minor defects.

| Item No. | Item to be Inspected | Inspection Standard | | | | Classification of defects | |
|---|--|---|---|--|------------|---------------------------|---|
| 1. | Spot defect (Defects in spot from) | Zone size (mm) | Acceptable Qty | | | Minor | |
| | | | A | B | C | | |
| | | $\Phi \leq 0.15$ | Acceptable (clutering of spot not allowed) | | Acceptable | | |
| | | $0.15 \leq \Phi \leq 0.20$ | 1 | 2 | | | |
| | | $0.20 \leq \Phi \leq 0.25$ | 0 | 1 | | | |
| | | $\Phi > 0.25$ | 0 | 0 | | | |
| Remarks : for dark/white spot, size Φ is defined as $\Phi = 1/2(X+Y)$ | | | | | | | |
| 2. | Line defect (Defects in line form) | Size (mm) | | Acceptable Qty | | Minor | |
| | | L | W | Zone | | | |
| | | Length | Width | A | B | | C |
| | | Acceptable | $W \leq 0.02$ | Acceptable | Acceptable | | |
| | | $L \leq 3.0$ | $W \leq 0.03$ | 2 | | | |
| | | $L > 2.5$ | $W \leq 0.03$ | 0 | | | |
| | | $L \leq 3.0$ | $0.03 < W \leq 0.05$ | 2 | | | |
| | | $L > 2.5$ | $0.03 < W \leq 0.05$ | 0 | | | |
| | | | $W > 0.05$ | Counted as spot defect (Follows item 17.5.1) | | | |
| Remarks: The total of spot defect and line defect shall not exceed four. | | | | | | | |
| 3. | Orientation defect (such as misalignment of L/C) | Not allowed inside viewing area (Zone A or Zone B) | | | | Minor | |
| 4. | Polarizing | 17.5.4.1 Polarizer Position | | | | Minor | |
| | | 1. Shifting in Position Should not exceed the glass outline dimension. | | | | | |
| | | 2. Incomplete covering of the viewing area due to Shifting is not allowed. | | | | | |
| | | 17.5.4.2 Seratches, bubble or dent on Glass/ Polarizer/Reflector, Bubble between Polarizer & Reflector/Glass: | | | | | |
| | | Size (mm) | Acceptable Qty | | | | |
| | | | Zone | | | | |
| | | | A | B | C | | |
| | | $\Phi \leq 0.20$ | Acceptable | | Acceptable | | |
| $0.20 < \Phi \leq 0.50$ | 3 | | | | | | |
| $0.50 < \Phi \leq 1.00$ | 2 | | | | | | |
| $\Phi > 1.00$ | 0 | | | | | | |

18. Character Generator ROM Map (Standard)

| CHARACTER PATTERN CHART (5x7 DOTS +CURSOR) | | | | | | | | | | | | | |
|--|---------------|------|------|------|------|------|------|------|------|------|------|------|------|
| Higher 4 bit Lower 4 bit | 0000 | 0010 | 0011 | 0100 | 0101 | 0110 | 0111 | 1010 | 1011 | 1100 | 1101 | 1110 | 1111 |
| XXXX0000 | CG RAM (1) | | 0 | a | P | \ | F | | - | 9 | ≡ | α | ρ |
| XXXX0001 | (2) | ! | 1 | A | Q | a | 9 | 。 | ア | チ | △ | ä | q |
| XXXX0010 | (3) | " | 2 | B | R | b | r | 「 | イ | ツ | × | β | θ |
| XXXX0011 | (4) | # | 3 | C | S | c | s | 」 | ウ | テ | € | ε | ω |
| XXXX0100 | (5) | \$ | 4 | D | T | d | t | 、 | イ | ト | ト | μ | Ω |
| XXXX0101 | (6) | % | 5 | E | U | e | u | 。 | オ | ナ | 1 | ε | ü |
| XXXX0110 | (7) | & | 6 | F | V | f | v | ヲ | カ | ニ | ヨ | ρ | Σ |
| XXXX0111 | (8) | ' | 7 | G | W | g | w | ア | キ | ヌ | ラ | q | π |
| XXXX1000 | (1) | (| 8 | H | X | h | x | ィ | ク | ネ | リ | ♪ | × |
| XXXX1001 | (2) |) | 9 | I | Y | i | y | ウ | ケ | ル | | ' | υ |
| XXXX1010 | (3) | * | : | J | Z | j | z | エ | コ | ハ | ロ | i | ≠ |
| XXXX1011 | (4) | + | ; | K | [| k | [| オ | サ | ヒ | ワ | * | π |
| XXXX1100 | (5) | , | < | L | ¥ | l | l | ヤ | シ | フ | ン | Φ | ⊙ |
| XXXX1101 | (6) | - | = | M |] | m |] | ユ | ヌ | ハ | ン | も | ÷ |
| XXXX1110 | (7) | . | > | N | ^ | n | ^ | ヨ | セ | ホ | ” | ñ | |
| XXXX1111 | (8) | / | ? | O | _ | o | _ | ← | ッ | リ | マ | ö | ■ |

19. Character Generator ROM Map (Russian)
ST7660-0T

| b7-b4 b3-b0 | 0000 | 0001 | 0010 | 0011 | 0100 | 0101 | 0110 | 0111 | 1000 | 1001 | 1010 | 1011 | 1100 | 1101 | 1110 | 1111 |
|----------------|------------------|------|------|------|------|------|------|------|------|------|------|------|------|------|------|------|
| 0000 | CG RAM (1) | | | 0 | 1 | 2 | 3 | 4 | | | 5 | 6 | 7 | 8 | 9 | 0 |
| 0001 | (2) | . | 1 | А | В | а | в | | | Г | Д | г | д | Е | Ж | е |
| 0010 | (3) | " | 2 | В | Р | б | р | | | Е | С | е | У | Ф | у | Ф |
| 0011 | (4) | # | 3 | С | С | с | с | | | Х | В | У | А | А | А | А |
| 0100 | (5) | \$ | 4 | Д | Т | д | т | | | З | Г | б | Г | Ф | Ф | Ф |
| 0101 | (6) | % | 5 | Е | У | е | у | | | Н | Е | а | а | У | Г | Г |
| 0110 | (7) | & | 6 | Ф | У | Ф | У | | | Р | В | В | Г | У | В | В |
| 0111 | (8) | ' | 7 | В | В | В | В | | | Д | З | В | Д | Г | Г | Г |
| 1000 | (1) | (| В | Н | Н | Н | Н | | | П | В | О | П | Г | Г | Г |
| 1001 | (2) |) | 9 | Т | У | Г | В | | | У | В | О | Г | Г | Г | Г |
| 1010 | (3) | * | : | Д | З | Д | З | | | Ф | К | А | Д | Е | Г | Г |
| 1011 | (4) | + | ; | К | Е | К | В | | | У | А | " | В | С | Г | Г |
| 1100 | (5) | , | < | Л | Ф | Г | В | | | У | В | В | В | В | В | В |
| 1101 | (6) | = | = | Н | Д | В | В | | | б | В | С | В | В | В | В |
| 1110 | (7) | . | > | Н | В | В | В | | | В | В | В | В | В | В | В |
| 1111 | (8) | / | ? | О | Л | О | В | | | В | Т | Е | " | О | | |