

DF-CLN0162---L1

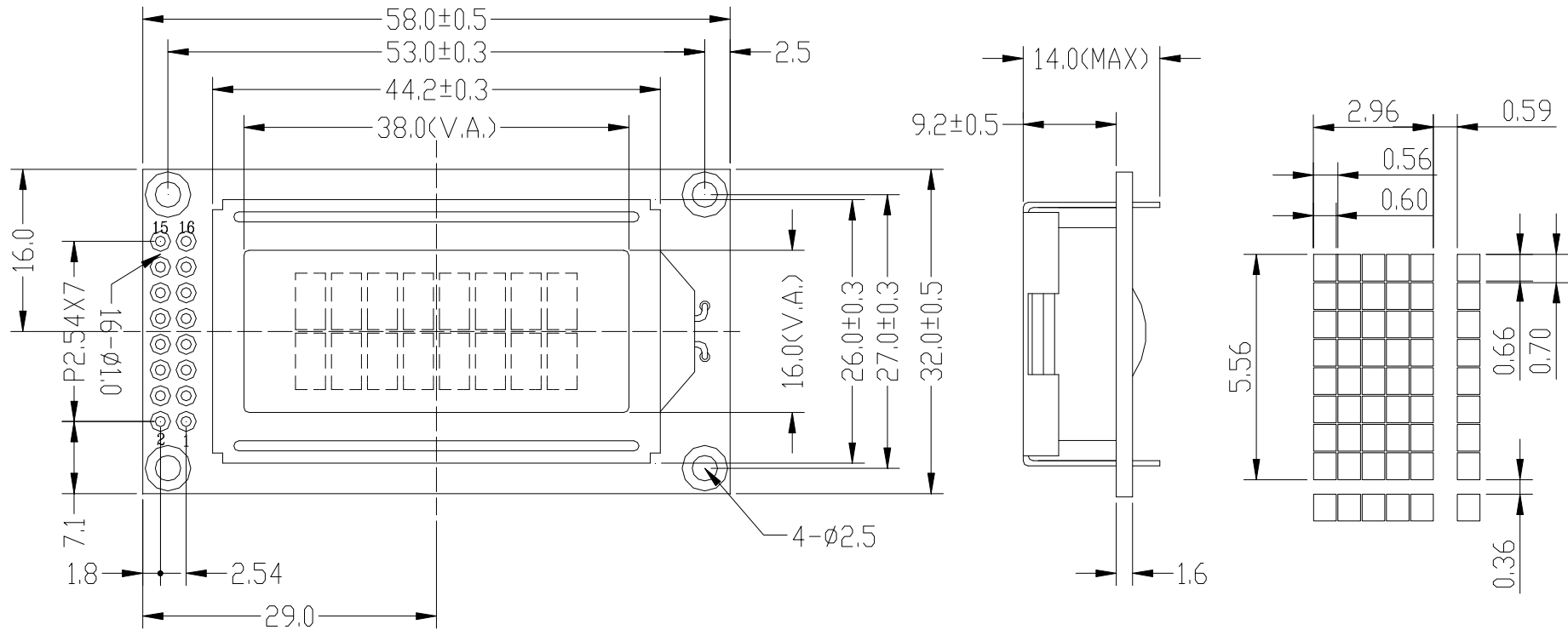

Feature

1. 8 Character x 2 line Character format; 5 x 7 dots + 1-Cursor line.
2. The LCD uses the SPLC780D Series LCD Driver from SUNPLUS ,or equivalent controller.
3. Interface With 4-bit or 8-bit MPU, 1/16 Duty cycle, 1/5 Bias.
4. Display Mode & Backlight Variations.
5. ROHS compliant.

Pin connections

Pin no	1	2	3	4	5	6	7	8	9	10	11	12	13	14	15	16
Symbol	VSS	VDD	V0	RS	RW	E	DB0	DB1	DB2	DB3	DB4	DB5	DB6	DB7	LED+	LED-