

Customer No.:

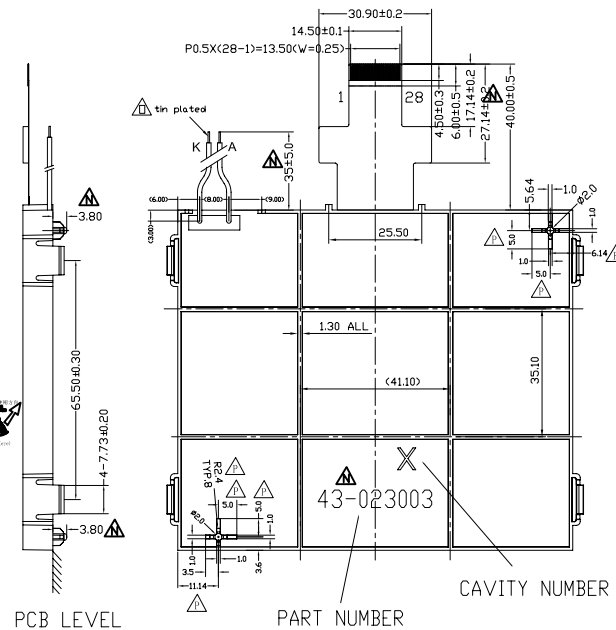

PIN	NAME
1	GND
2	VOUT2
3	RWRDB_SDI
4	RS
5	RESETB
6	EWVB_SCL
7	IM0
8	IM1
9	IM2
10	CSB
11	VCC
12	VPP
13	DB0
14	DB1
15	DB2
16	DB3
17	DB4
18	DB5
19	DB6
20	DB7
21	DB8
22	DB9
23	DB10
24	DB11
25	DB12
26	DB13
27	DB14
28	DB15

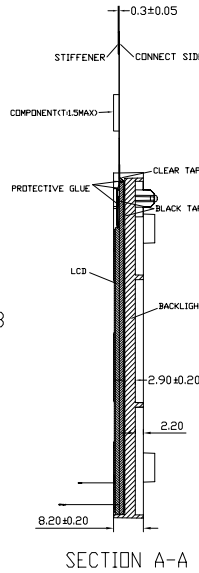
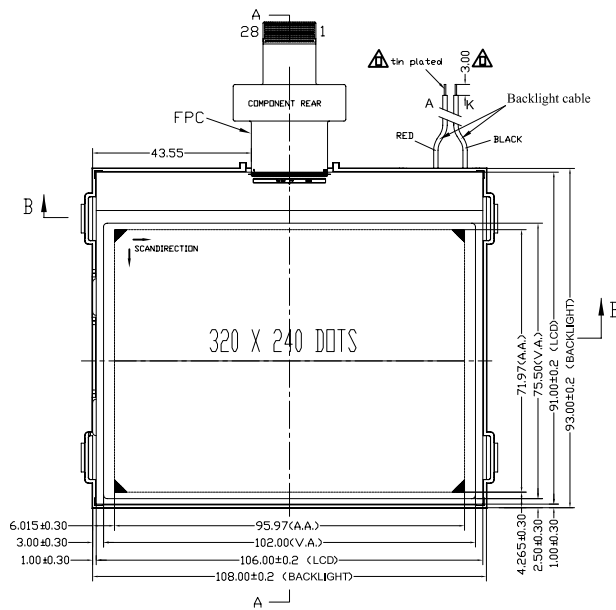
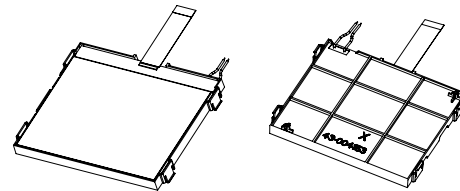
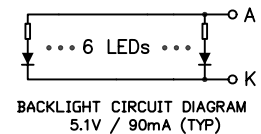
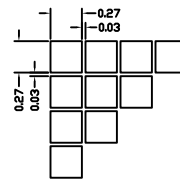
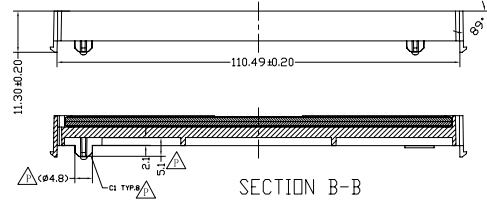

NOTES:

- DISPLAY TYPE:
Main LCD: FSTN/Positive/Tranfective
- Controller IC: IST3088CA1
- OPERATING TEMP: -20°C~70°C
- STORAGE TEMP: -30°C~80°C
- DUTY: 1/240 BIAS: 1/16; VCC: 3.0V; Vop: 25.0V
- BACKLIGHT: SIDE LIGHT, 6LEDs, WHITE
- ROHS COMPLIANT

CUSTOMER APPROVE		AMEND	
Mechanical	Electrical		
NO.	CONTENT	DATE	

NO.	NAME	QTY	Part No.	REVISION
	液晶显示模块			
MULTI-INNO TECHNOLOGY CO.,LTD.				
PRODUCT NO.		DRAW NO.		REV
MI320240Y-G		LCM0879		A
DWN	20091130	DSN	20091130	
CHKD	20091130	APPD	20091130	
NOT IN SCALE UNIT mm SHEET: 1/1				