



MULTI-INNO TECHNOLOGY CO., LTD.

LCD MODULE SPECIFICATION

Model : MI10656A-G-2

Revision	1.0
Engineering	
Date	
Our Reference	



REVISION RECORD

Date	Ref. Page	Revision No.	Revision Items	Check & Approval



1. General Specifications:

- 1.1 Display type: FSTN
- 1.2 Display color*:
 - Display color: Blue-Black
 - Background: White
- 1.3 Polarizer mode: Transflective/Positive
- 1.4 Viewing Angle: 6:00
- 1.5 Driving Method: 1/65 Duty 1/9 Bias
- 1.6 Lcd operation voltage: 9.5V Vdd=3.0V
- 1.7 Backlight: Yellow-Green LED type
- 1.8 Controller: S6B0724A01-B0C or ST7565R or the equivalent
- 1.9 Data Transfer: Serial
- 1.10 Operating Temperature: -20----+70°C
 - Storage Temperature: -30----+80°C
- 1.11 Outline Dimensions: Refer to outline drawing on next page
- 1.12 Dot Matrix: 106 X 56
- 1.13 Dot Size: 0.27X0.27(mm)
- 1.14 Dot Pitch: 0.29X0.29 (mm)
- 1.15 Weight: 20g

* Color tone is slightly changed by temperature and driving voltage.

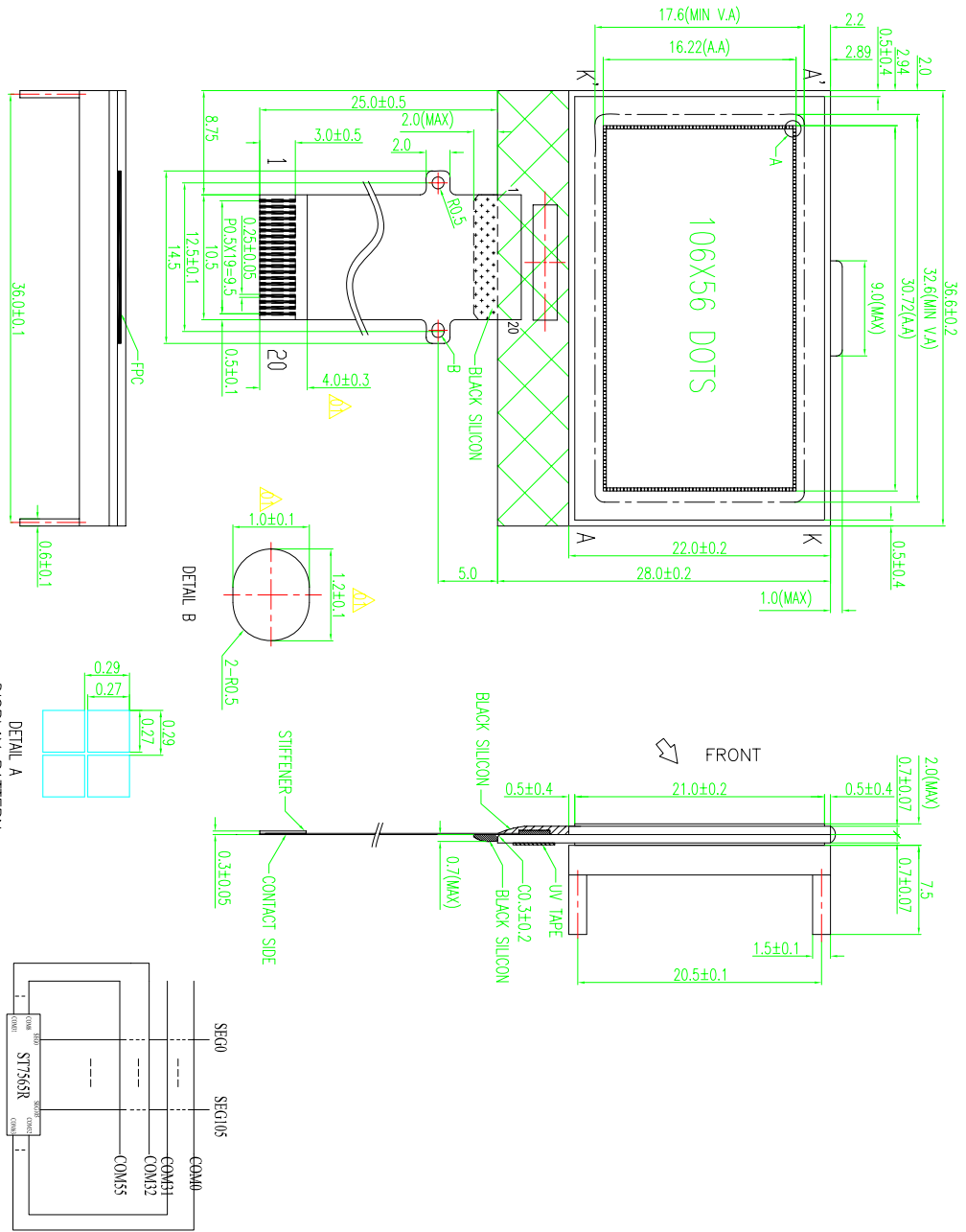

PIN CONNECTION:

NO.	SYMBOL
1	N/C
2	V0
3	V1
4	V2
5	V3
6	V4
7	C2-
8	C2+
9	C1+
10	C1-
11	C3+
12	V0R
13	VSS
14	VDD
15	SID
16	SQLK
17	RS
18	RESETB
19	CS1B
20	N/C

- NOTES:
1. DISPLAY TYPE: FSTN MODE, TRANSPARENT/POSITIVE.
 2. DRIVE METHOD: DUTY=1/65, BIAS=1/9, VDD=3.0V, VOP=9.5V.
 3. VIEWING DIRECTION: 6 O'CLOCK.
 4. DRIVER: S6800724 or ST7565R or the equivalent.
 5. OPERATING TEMP: -30°C~80°C.
 6. STORAGE TEMP: -20°C~70°C.
 7. BACKLIGHT TYPE: EDGE BACKLIGHT-Y-G, LEDA-LEDK=4.2V.
 8. UNMARKED TOLERANCE: ±0.3mm.
 9. ROHS COMPLIANT.



3. LCD Module Part Numbering System:

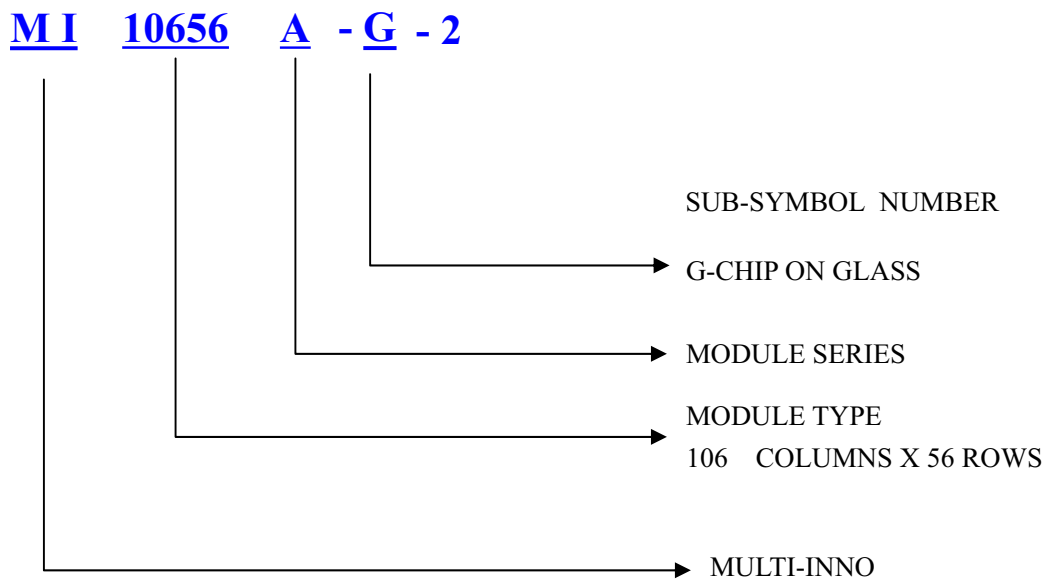

4 Circuit Block Diagram

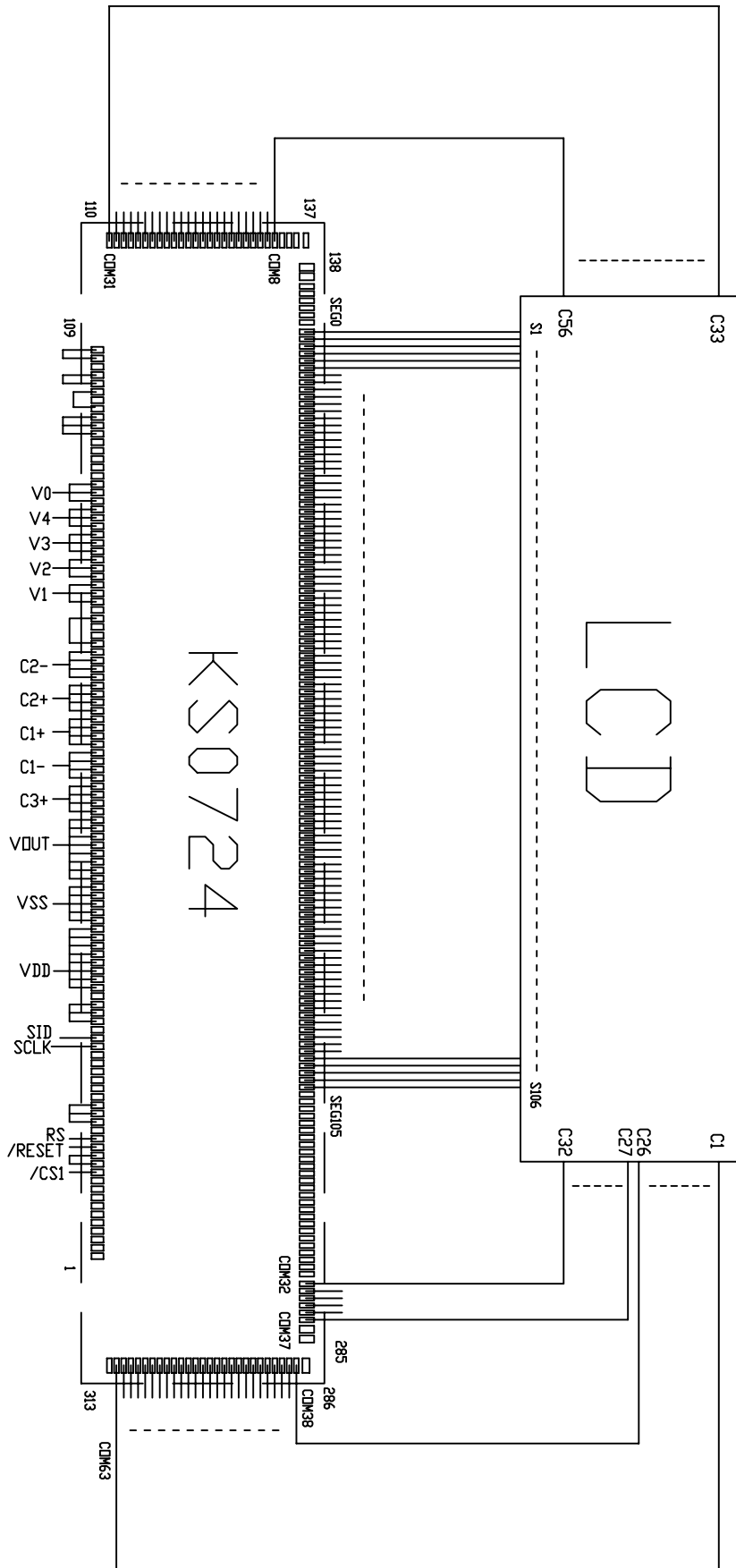

**5 Absolute Maximum Ratings**

Item	Symbol	Min.	Max.	Unit	Remark
Power Supply Voltage	$V_{DD}-V_{SS}$	2.4	3.6	V	
LCD Driving Voltage	V_{LCD}	4.5	15.0		
Operating Temperature Range	T_{OP}	-20	+70	°C	No Condensation
Storage Temperature Range	T_{ST}	-30	+80		



6 Electrical Specifications and Instruction Code

6.1 Electrical characteristics

Item	Symbol	Min.	Typ.	Max.	Unit	
Supply Voltage (Logic)	$V_{DD}-V_{SS}$	2.8	3.0	3.2	V	
Supply Voltage (LCD Drive)	V_{LCD}	9.0	9.5	10.0	V	
Input Signal Voltage	High	V_{IH} ($V_{DD}=3.0$)	0.8 V_{DD}	-	V_{DD}	V
	Low	V_{IL} ($V_{DD}=3.0$)	0	-	0.2 V_{DD}	V
Supply current (Logic) (Display character)	I_{DD} ($V_{DD}-V_{SS}=3.0V$)	-	-	400	uA	

6.2 Interface Signals

Pin No.	Symbol	Level	Description
1	NC	-	No connection
2	V0	9.5V	Power supply voltage for LCD
3	V4	-	Power supply voltage for LCD
4	V3	-	Power supply voltage for LCD
5	V2	-	Power supply voltage for LCD
6	V1	-	Power supply voltage for LCD
7	C2-	-	Capacitor pin for voltage converter
8	C2+	-	Capacitor pin for voltage converter
9	C1+	-	Capacitor pin for voltage converter
10	C1-	-	Capacitor pin for voltage converter
11	C3+	-	Capacitor pin for voltage converter
12	VOUT	-	DC/DC voltage converter output
13	VSS	0V	Ground
14	VDD	3.0V	Power supply voltage for logic
15	SID	H/L	Serial data input pin
16	SCLK	H/L	Serial clock input pin
17	RS	H/L	Register select input pin
18	/RES	H/L	Reset input pin
19	CS1	H/L	Chip select input pin
20	NC	-	No connection

6.3 Interface Timing Chart

Serial Interface Characteristics

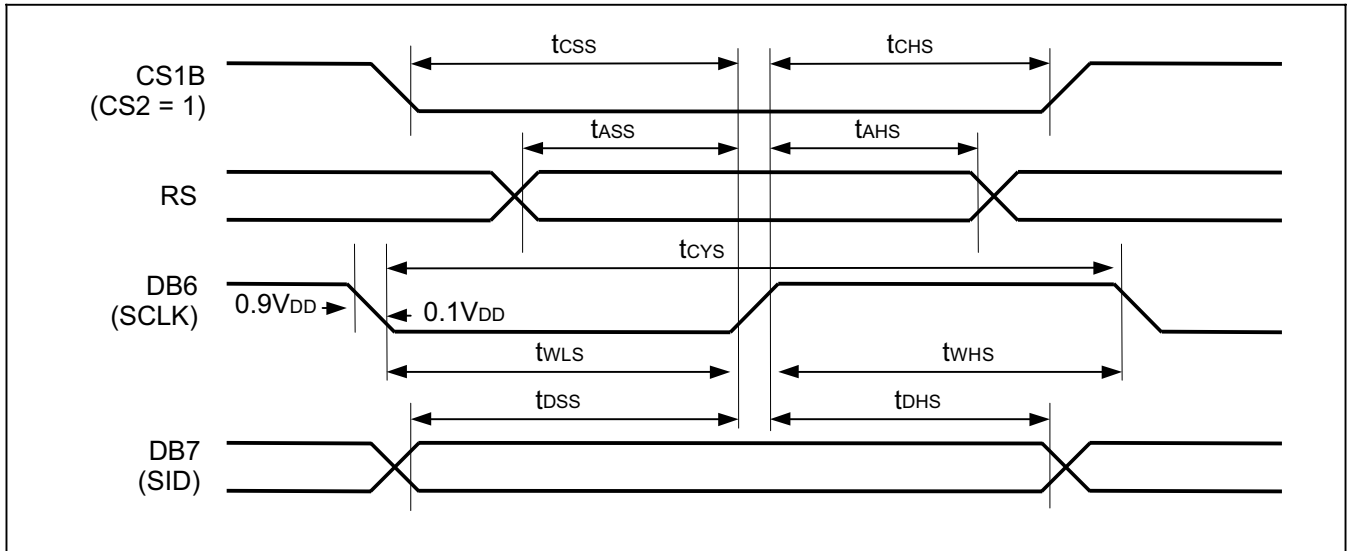

Serial Interface Characteristics

($V_{DD} = 2.4$ to $3.6V$, $T_a = -40$ to $+85^{\circ}C$)

Item	Signal	Symbol	Min.	Typ.	Max.	Unit	Remark
Serial clock cycle	DB6 (SCLK)	t_{cYS}	250	-	-	ns	
SCLK high pulse width		t_{wHS}	100	-	-		
SCLK low pulse width		t_{wLS}	100	-	-		
Address setup time	RS	t_{ASS}	150	-	-	ns	
Address hold time		t_{AHS}	150	-	-		
Data setup time	DB7 (SID)	t_{dSS}	100	-	-	ns	
Data hold time		t_{dHS}	100	-	-		
CS1B setup time	CS1B	t_{cSS}	150	-	-	ns	
CS1B hold time		t_{CHS}	150	-	-		

6.4 Instruction Code

INSTRUCTION DESCRIPTION
Instruction Table

×: Don't care

Instruction	RS	RW	DB7	DB6	DB5	DB4	DB3	DB2	DB1	DB0	Description
Display ON / OFF	0	0	1	0	1	0	1	1	1	DON	Turn on/off LCD panel When DON = 0: display OFF When DON = 1: display ON
Initial display line	0	0	0	1	ST5	ST4	ST3	ST2	ST1	ST0	Specify DDRAM line for COM0
Set page address	0	0	1	0	1	1	P3	P2	P1	P0	Set page address
Set column address MSB	0	0	0	0	0	1	Y7	Y6	Y5	Y4	Set column address MSB
Set column address LSB	0	0	0	0	0	0	Y3	Y2	Y1	Y0	Set column address LSB
Read status	0	1	BUSY	ADC	ONOFF	RESETB	0	0	0	0	Read the internal status
Write display data	1	0	Write data								Write data into DDRAM
Read display data	1	1	Read data								Read data from DDRAM
ADC select	0	0	1	0	1	0	0	0	0	ADC	Select SEG output direction When ADC = 0: normal direction (SEG0→SEG131) When ADC = 1: reverse direction (SEG131→SEG0)
Reverse display ON / OFF	0	0	1	0	1	0	0	1	1	REV	Select normal / reverse display When REV = 0: normal display When REV = 1: reverse display
Entire display ON / OFF	0	0	1	0	1	0	0	1	0	EON	Select normal/entire display ON When EON = 0: normal display. When EON = 1: entire display ON
LCD bias select	0	0	1	0	1	0	0	0	1	BIAS	Select LCD bias
Set modify-read	0	0	1	1	1	0	0	0	0	0	Set modify-read mode
Reset modify-read	0	0	1	1	1	0	1	1	1	0	release modify-read mode
Reset	0	0	1	1	1	0	0	0	1	0	Initialize the internal functions
SHL select	0	0	1	1	0	0	SHL	×	×	×	Select COM output direction When SHL = 0: normal direction (COM0→COM63) When SHL = 1: reverse direction (COM63→COM0)
Power control	0	0	0	0	1	0	1	VC	VR	VF	Control power circuit operation
Regulator resistor select	0	0	0	0	1	0	0	R2	R1	R0	Select internal resistance ratio of the regulator resistor
Set reference voltage mode	0	0	1	0	0	0	0	0	0	1	Set reference voltage mode
Set reference voltage register	0	0	×	×	SV5	SV4	SV3	SV2	SV1	SV0	Set reference voltage register
Set static indicator mode	0	0	1	0	1	0	1	1	0	SM	Set static indicator mode
Set static indicator register	0	0	×	×	×	×	×	×	S1	S0	Set static indicator register
Power save	-	-	-	-	-	-	-	-	-	-	Compound Instruction of display OFF and entire display ON

**7 Optical Characteristics**

7.1 Optical Characteristics

Ta=25°C

Item	Symbol	Condition	Min.	Typ.	Max.	Unit	
Viewing Angle	θ_x	$C_r \geq 2$	$\theta_y = 0^\circ$	-30	--	20	Deg
	θ_y						
Contrast Ratio	C_r	$\theta_x = 0^\circ$ $\theta_y = 0^\circ$	3.0	-	-		
Response Time	Turn on	$\theta_x = 0^\circ$ $\theta_y = 0^\circ$	-	-	300	ms	
	Turn off						-

7.2 Definition of Optical Characteristics

7.2.1 Definition of Viewing Angle

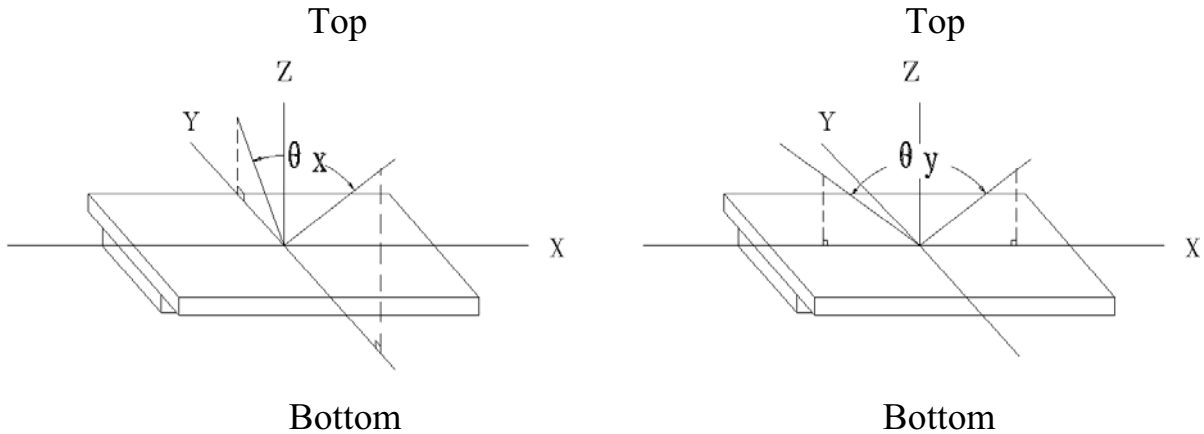

7.2.2 Definition of Contrast Ratio

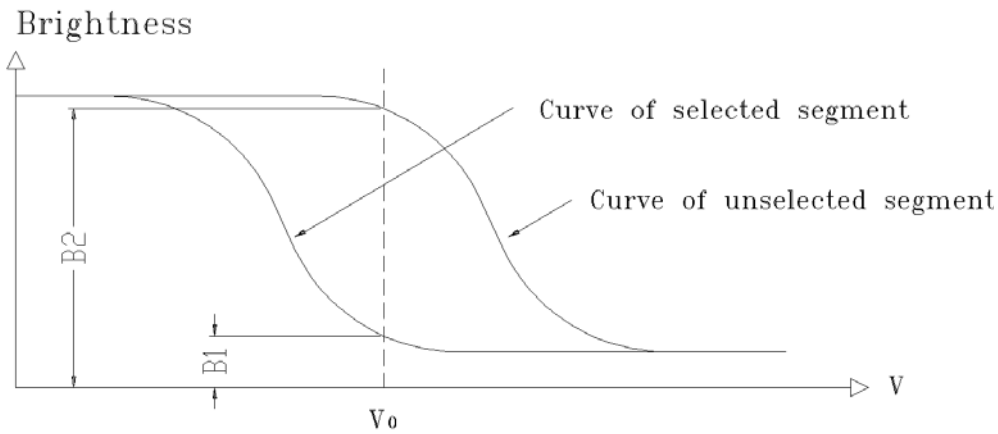

$$\text{Contrast Ratio} = B2/B1 = \frac{\text{unselected state brightness}}{\text{selected state brightness}}$$

Measuring Conditions:

- 1) Ambient Temperature: 25°C ;
- 2) Frame frequency: 64Hz

7.2.3 Definition of Response time

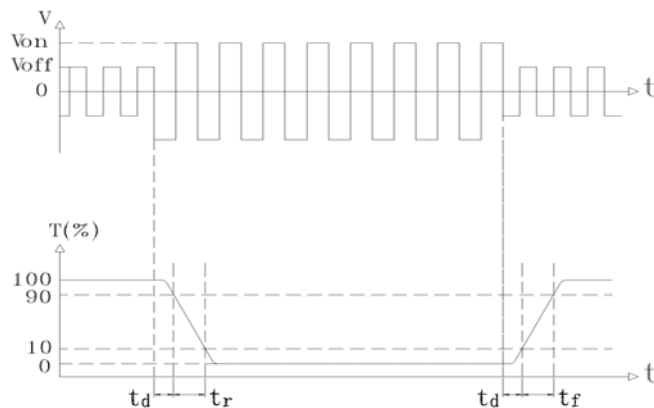

Turn on time: $t_{on} = t_d + t_r$ Turn off time: $t_{off} = t_d + t_f$

Measuring Condition:

- 1) Operating Voltage: 9.5V
- 2) Frame frequency: 64Hz

8 Reliability

8.1 Content of Reliability Test

Ta=25°C

No.	Test Item	Content of Test	Test condition
1	High Temperature Storage	Endurance test applying the high storage temperature for a long time	80°C 96H
2	Low Temperature Storage	Endurance test applying the low storage temperature for a long time	-30°C 96H
3	High Temperature Operation	Endurance test applying the electric stress (voltage & current) and the thermal stress to the element for a long time	70°C 96H
4	Low Temperature Operation	Endurance test applying the electric stress under low temperature for a long time	-20°C 96H
5	High Temperature /Humidity Storage	Endurance test applying the high temperature and high humidity storage for a long time	40°C 90%RH 96H
6	Temperature Cycle	Endurance test applying the low and high temperature cycle $ \begin{array}{ccccccc} -20^{\circ}\text{C} & \longleftrightarrow & 25^{\circ}\text{C} & \longleftrightarrow & 60^{\circ}\text{C} & \longleftrightarrow & 25^{\circ}\text{C} \\ 30\text{min} & & 5\text{min} & & 30\text{min} & & 5\text{min} \\ \longleftarrow & & & & & & \longrightarrow \\ & & & & \text{1 cycle} & & \end{array} $	-20°C/60°C 10 cycles
7	Vibration Test (package state)	Endurance test applying the vibration during transportation	10Hz~150Hz, 50m/s ² , 40min
8	Shock Test (package state)	Endurance test applying the shock during transportation	Half- sine wave, 100m/s ² , 1ms
9	Atmospheric Pressure Test	Endurance test applying the atmospheric pressure during transportation by air	40kPa 16H

8.2 Failure Judgment Criterion

Criterion Item	Test Item No.									Failure Judgement Criterion
	1	2	3	4	5	6	7	8	9	
Basic Specification	√	√	√	√	√	√	√	√	√	Out of the basic Specification
Electrical specification	√	√	√	√	√					Out of the electrical specification
Mechanical Specification							√	√		Out of the mechanical specification
Optical Characteristic	√	√	√	√	√	√			√	Out of the optical specification
Note	For test item refer to 8.1									
Remark	Basic specification = Optical specification + Mechanical specification									

9 QUALITY LEVEL

Examination or Test	At $T_a=25^\circ\text{C}$ (unless otherwise stated)	Inspection				
		Min.	Max.	Unit	IL	AQL
External Visual Inspection	Under normal illumination and eyesight condition, the distance between eyes and LCD is 25cm.	See Appendix A			II	Major 1.0 Minor 2.5
Display Defects	Under normal illumination and eyesight condition, display on inspection.	See Appendix B			II	Major 1.0 Minor 2.5
Note: Major defects: Open segment or common, Short, Serious damages, Leakage Miner defects: Others Sampling standard conforms to GB2828						

10 Precautions for Use of LCD Modules

10.1 Handling Precautions

10.1.1 The display panel is made of glass. Do not subject it to a mechanical shock by dropping it from a high place, etc.

10.1.2 If the display panel is damaged and the liquid crystal substance inside it leaks out, be sure not to get any in your mouth, if the substance comes into contact with your skin or clothes, promptly wash it off using soap and water.

10.1.3 Do not apply excessive force to the display surface or the adjoining areas since this may cause the color tone to vary.

10.1.4 The polarizer covering the display surface of the LCD module is soft and easily scratched. Handle this polarizer carefully.

10.1.5 If the display surface is contaminated, breathe on the surface and gently wipe it with a soft dry cloth. If still not completely clear, moisten cloth with one of the following solvents:

- Isopropyl alcohol
- Ethyl alcohol

Solvents other than those mentioned above may damage the polarizer. Especially, do not use the following:

- Water
- Ketone
- Aromatic solvents

10.1.6 Do not attempt to disassemble the LCD Module.

10.1.7 If the logic circuit power is off, do not apply the input signals.

10.1.8 To prevent destruction of the elements by static electricity, be careful to maintain an optimum work environment.

- a. Be sure to ground the body when handling the LCD Modules.
- b. Tools required for assembly, such as soldering irons, must be properly ground.
- c. To reduce the amount of static electricity generated, do not conduct assembly and other work under dry conditions.
- d. The LCD Module is coated with a film to protect the display surface. Be care when peeling off this protective film since static electricity may be generated.



10.2 Storage precautions

10.2.1 When storing the LCD modules, avoid exposure to direct sunlight or to the light of fluorescent lamps.

10.2.2 The LCD modules should be stored under the storage temperature range. If the LCD modules will be stored for a long time, the recommend condition is:

Temperature : $0^{\circ}\text{C} \sim 40^{\circ}\text{C}$

Relatively humidity: $\leq 80\%$

10.2.3 The LCD modules should be stored in the room without acid, alkali and harmful gas.

10.3 The LCD modules should be no falling and violent shocking during transportation, and also should avoid excessive press, water, damp and sunshine.

Appendix A

Inspection items and criteria for appearance defects

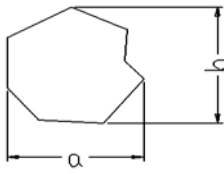
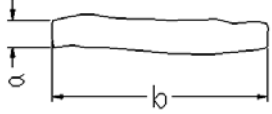
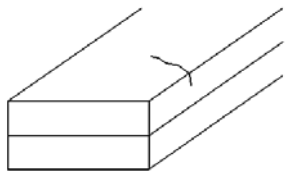
Items	Contents	Criteria		
Protective Glue		No clear defects		
Cover Tape		Covering all of the chip and no clear crimple		
Leakage		Not permitted		
Rainbow		According to the limit specimen		
Polarizer	Wrong polarizer attachment	Not permitted		
	Bubble between polarizer and glass	Not counted	Max. 3 defects allowed	
		$\phi < 0.3\text{mm}$	$0.3\text{mm} \leq \phi \leq 0.5\text{mm}$	
	Scratches of polarizer	According to the limit specimen		
Black spot (in viewing area)		Not counted	Max. 3 spots allowed	
		$X < 0.2\text{mm}$	$0.2\text{mm} \leq X \leq 0.5\text{mm}$	
		$X = (a+b)/2$		
Black line (in viewing area)		Not counted	Max. 3 lines allowed	
		$a < 0.02\text{mm}$	$0.02\text{mm} \leq a \leq 0.05\text{mm}$ $b \leq 2.0\text{mm}$	
Progressive cracks		Not permitted		

Appendix A

Inspection item and criteria for appearance defects (continued)

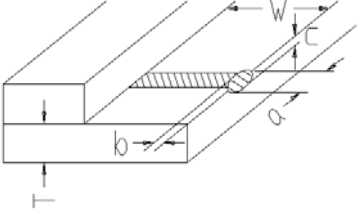
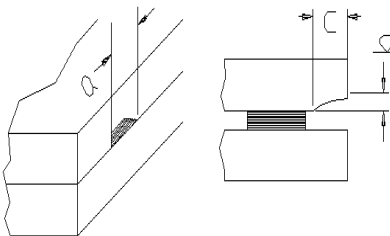
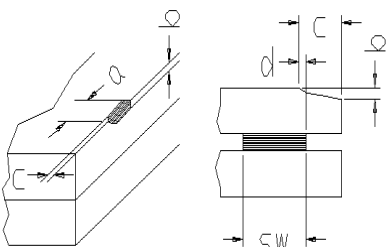
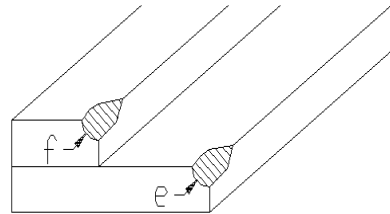
Items	Contents	Criteria			
		a	b	c	
Glass Cracks	Cracks on pads 	$\leq 3\text{mm}$	$\leq W/5$	$\leq T/2$	Max. 2 cracks allowed
	$\leq 2\text{mm}$	$\leq W/5$	$T/2 < C < T$		
	Cracks on contact side 	$\leq 3\text{mm}$	$\leq T/2$	Max. 2 cracks allowed	Max. 5 cracks allowed
	$\leq 2\text{mm}$	$T/2 < b < T$			
	C shall be not reach the seal area				
	Cracks on non-contact side 	$\leq 3\text{mm}$	$\leq T/2$	Max. 2 cracks allowed	
	$\leq 2\text{mm}$	$T/2 < b < T$			
	$C \leq 0.5\text{mm}$				
	$d \leq SW/3$				
	Corner cracks 	$e < 2.0\text{mm}^2$	$f < 2.0\text{mm}^2$	Max. 3 cracks allowed	

Appendix B

Inspection items and criteria for display defects

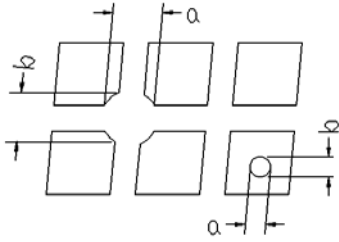
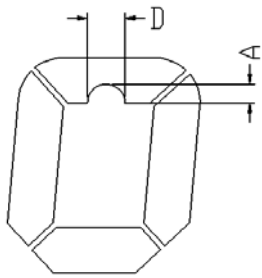
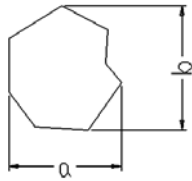
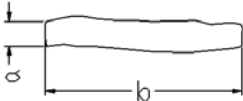
Items	Contents	Criteria			
Open segment or open common		Not permitted			
Short		Not permitted			
Wrong viewing angle		Not permitted			
Contrast ratio uneven		According to the limit specimen			
Crosstalk		According to the limit specimen			
Pin holes and cracks in segment (DOT)		Not counted	Max.3 dots allowed		Max.3 dots allowed
		$X < 0.1\text{mm}$	$0.1\text{mm} \leq X \leq 0.2\text{mm}$		
		$X = (a+b)/2$			
		Not counted	Max.2 dots allowed		
$A < 0.1\text{mm}$		$0.1\text{mm} \leq A \leq 0.2\text{mm}$ $D < 0.25\text{mm}$			
Black spot (in viewing area)		Not counted	Max.3 spots allowed		Max.3 spots (lines) allowed
		$X < 0.1\text{mm}$	$0.1\text{mm} \leq X \leq 0.2\text{mm}$		
		$X = (a+b)/2$			
Black line (in viewing area)		Not counted	Max.3 lines allowed		
		$a < 0.02\text{mm}$	$0.02\text{mm} \leq a \leq 0.05\text{mm}$ $b \leq 0.5\text{mm}$		

Appendix B

Inspection items and criteria for display defects (continued)

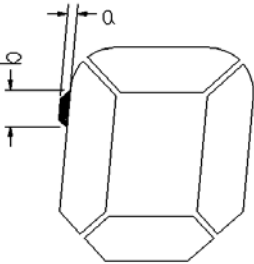
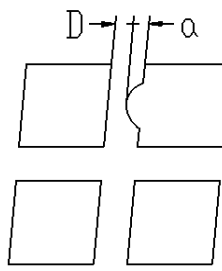
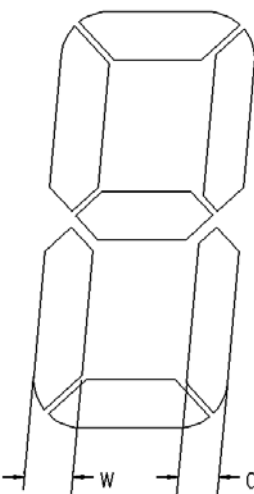
Items	Content	Criteria				
Transformation of segment		Not counted	Max. 2 defects allowed	Max.3 defects allowed		
		$x < 0.1\text{mm}$	$0.1\text{mm} \leq x \leq 0.2\text{mm}$			
		$x = (a+b)/2$				
		Not counted	Max. 1 defects allowed			
		$a < 0.1\text{mm}$	$0.1\text{mm} \leq a \leq 0.2\text{mm}$ $D > 0$			
		Max.2 defects allowed $0.8W \leq a \leq 1.2W$ a=measured value of width W=nominal value of width				