



MULTI-INNO TECHNOLOGY CO., LTD.

LCD MODULE SPECIFICATION

Model : MI2004A

Revision	1.0
Engineering	
Date	
Our Reference	

Address : Room 10J,Xin HaoFang Building, No.188 Shennan Road,
Nanshan Drstrict, ShenZhen,China.

Tel : (86-755)2643 9937

Fax : (86-755)8613 4241

Email : sales@multi-inno.com

Web : <http://www.multi-inno.com>



MODE OF DISPLAY**Display mode**

- TN positive
- TN negative
- STN : Yellow green
 - Grey
 - Blue (negative)
- FSTN positive
- FSTN negative

Display condition

- Reflective type
- Transflective type
- Transmissive type
- Others

Viewing direction

- 6 O' clock
- 12 O' clock
- 3 O' clock
- 9 O' clock

GENERAL DESCRIPTION

Display mode : 20 characters x 4 lines LCD module
 Interface : 4-bit or 8-bit parallel
 Driving method : 1/16 duty, 1/5 bias
 Controller IC : Sitronix ST7066U or equivalent
 For the detailed information, please refer to the IC specifications

MECHANICAL DIMENSIONS

Item	Dimension		Unit	Item	Dimension		Unit
Outline Dimension	146.0(L)x62.5(W)x(H1/H2)		mm	Character Pitch	6.0(L)x9.75(W)		mm
Viewing Area	123.0(L)x42.5(W)		mm	Dot Size	0.92(L)x1.10(W)		mm
Character Size	4.84(L)x9.22(W)		mm	—	—		—
No Backlight (N)	H1	—	mm	Side Backlight (L)	H1	9.4	mm
	H2	—	mm		H2	14.0	mm
EL Backlight (E)	H1	—	mm	Array Backlight (M)	H1	9.4	mm
	H2	—	mm		H2	14.0	mm

CONNECTOR PIN ASSIGNMENT

Pin No.	Signal	Function	Pin No.	Signal	Function
1	VSS	Ground	9	DB2	Data Bus Line
2	VDD	Supply voltage for logic	10	DB3	Data Bus Line
3	V0	Input voltage for LCD	11	DB4	Data Bus Line
4	RS	Register Select Input	12	DB5	Data Bus Line
5	R/W	Read/Write	13	DB6	Data Bus Line
6	E	Enable Signal	14	DB7	Data Bus Line
7	DB0	Data Bus Line	15	BL+	Supply voltage for backlight(+VE)
8	DB1	Data Bus Line	16	BL-	Supply voltage for backlight(-VE)

Note (*) : Pin 15,16 are used for backlight version

COUNTER DRAWING OF MODULE DIMENSION

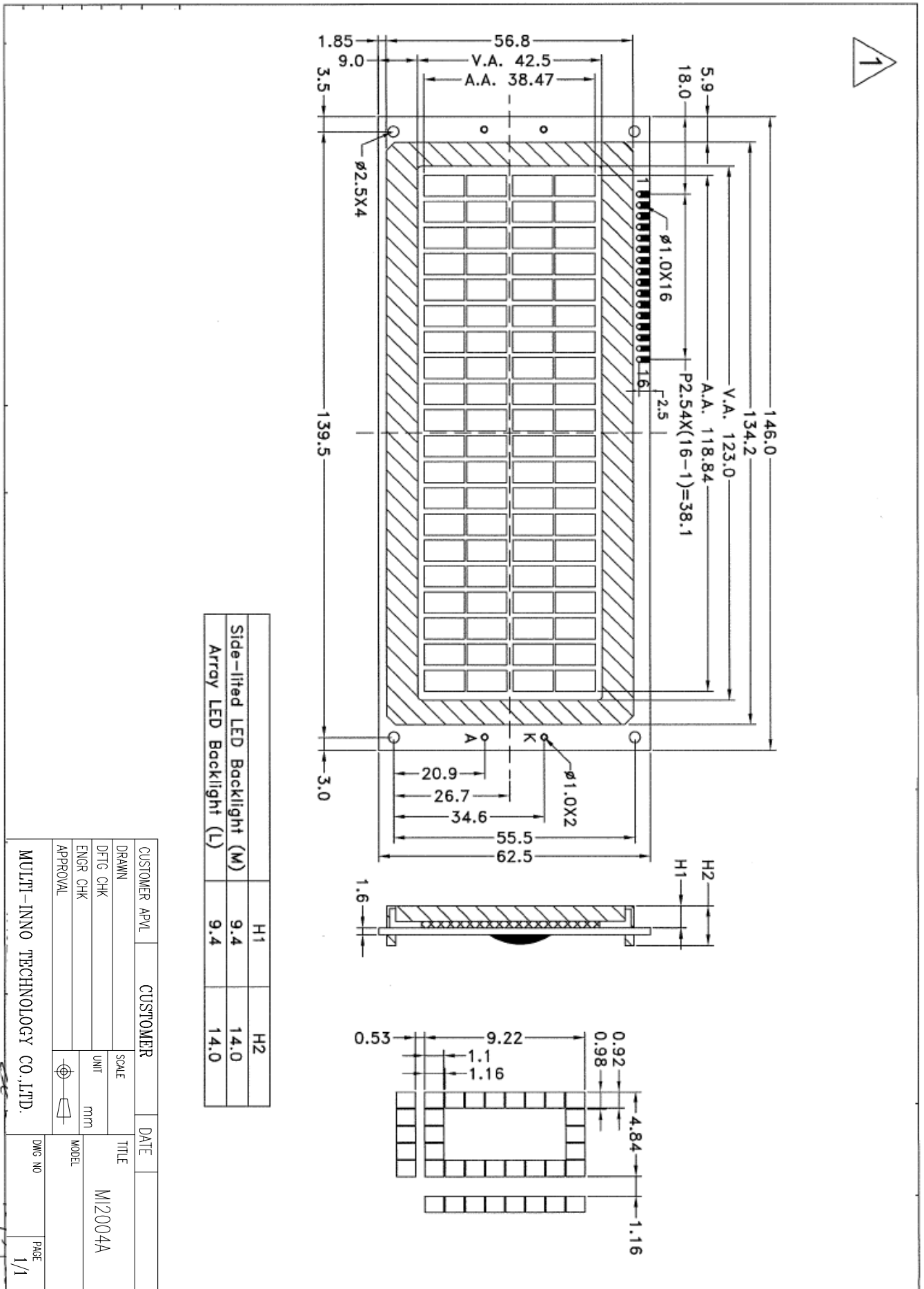

COUNTER DRAWING OF PIN OUT & BLOCK DIAGRAM

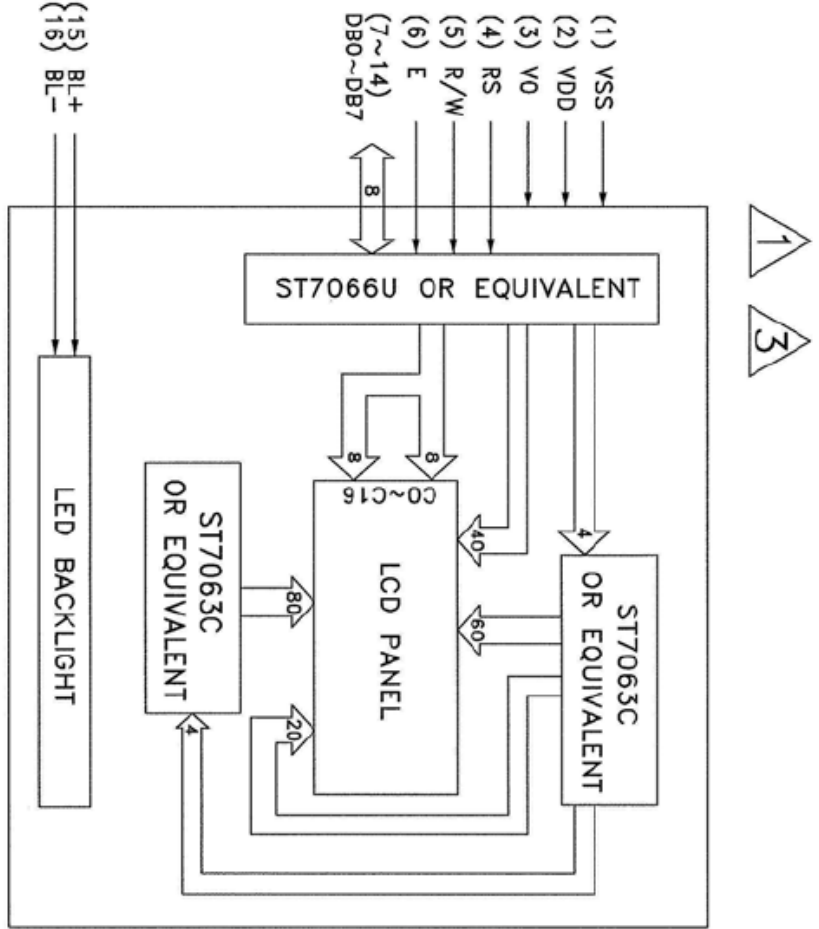

PIN NO.	SYMBOL	FUNCTION
1	VSS	Ground
2	VDD	Supply voltage for logic
3	VO	Input voltage for LCD
4	RS	Register select input
5	R/W	Read/Write
6	E	Enable signal
7	DB0	Data bus line
8	DB1	
9	DB2	
10	DB3	
11	DB4	
12	DB5	
13	DB6	
14	DB7	
15	BL+	Supply voltage for backlight (+VE)
16	BL-	Supply voltage for backlight (-VE)

CUSTOMER APVL	CUSTOMER	DATE
DRAWN	SCALE	TITLE
DFTG CHK	UNIT	MI2004A
ENGR CHK	mm	MODEL
APPROVAL		
MULTI-INNO TECHNOLOGY CO.,LTD.		DWG NO
		PAGE
		1/1

**ELECTRICAL CHARACTERISTICS**

Conditions: VSS=0V, @Ta=25°C

Item	Symbol	MIN.	TYP.	MAX.	Unit	Item	Symbol	MIN.	TYP.	MAX.	Unit
Supply Voltage	VDD	4.75	5.00	5.25	V	“H”Level Input Voltage	VIH	0.7VDD	—	VDD	V
Supply Current	IDD	—	1.8	2.6	mA	“L”Level Input Voltage	VIL	-0.3	—	0.6	V
Input Voltage for LCD	V0	0.3	0.5	0.7	V	—	—	—	—	—	—
EL Backlight Voltage						Backlight Current					
EL (@ Frequency 400Hz)	VEL	—	—	—	V _{rms}	—	—	—	—	—	—
Side-lited LED						Side-lited LED					
White	VBL	—	5.0	—	V	White	IBL	60	70	80	mA
Blue	VBL	—	—	—	V	Blue	IBL	—	—	—	mA
Yellow Green	VBL	—	—	—	V	Yellow Green	IBL	—	—	—	mA
Array LED						Array LED					
Yellow Green	VBL	—	4.20	4.60	V	Yellow Green	IBL	—	880	1700	mA
Amber	VBL	—	—	—	V	Amber	IBL	—	—	—	mA
Orange	VBL	—	—	—	V	Orange	IBL	—	—	—	mA
Soft Orange	VBL	—	—	—	V	Soft Orange	IBL	—	—	—	mA

ABSOLUTE MAXIMUM RATINGS

Please make sure not to exceed the following maximum rating values under the worst application conditions

Item	Symbol	Rating (for normal temperature)	Rating (for wide temperature)	Unit
Supply Voltage	VDD	-0.3 to 7	-0.3 to 7	V
Input Voltage	VT	-0.3 to VDD +0.3	-0.3 to VDD +0.3	V
Operating Temperature	T _{opr}	0 to 50	-20 to 70	°C
Storage Temperature	T _{stg}	-10 to 60	-30 to 80	°C

INSTRUCTIONS

Instruction	Instruction Code										Description	Description Time (270KHz)	
	RS	R/W	DB7	DB6	DB5	DB4	DB3	DB2	DB1	DB0			
Clear Display	0	0	0	0	0	0	0	0	0	0	1	Write "20H" to DDRAM. and set DDRAM address to "00H" from AC	1.52 ms
Return Home	0	0	0	0	0	0	0	0	0	1	x	Set DDRAM address to "00H" from AC and return cursor to its original position if shifted. The contents of DDRAM are not changed.	1.52 ms
Entry Mode Set	0	0	0	0	0	0	0	0	1	I/D	S	Sets cursor move direction and specifies display shift. These operations are performed during data write and read.	37 us
Display ON/OFF	0	0	0	0	0	0	0	1	D	C	B	D=1:entire display on C=1:cursor on B=1:cursor position on	37 us
Cursor or Display Shift	0	0	0	0	0	0	1	S/C	R/L	x	x	Set cursor moving and display shift control bit, and the direction, without changing DDRAM data.	37 us
Function Set	0	0	0	0	1	DL	N	F	x	x		DL:interface data is 8/4 bits N:number of line is 2/1 F:font size is 5x11/5x8	37 us
Set CGRAM address	0	0	0	1	AC5	AC4	AC3	AC2	AC1	AC0		Set CGRAM address in address counter	37 us
Set DDRAM address	0	0	1	AC6	AC5	AC4	AC3	AC2	AC1	AC0		Set DDRAM address in address counter	37 us
Read Busy flag and address	0	1	BF	AC6	AC5	AC4	AC3	AC2	AC1	AC0		Whether during internal operation or not can be known by reading BF. The contents of address counter can also be read.	0 us
Write data to RAM	1	0	D7	D6	D5	D4	D3	D2	D1	D0		Write data into internal RAM (DDRAM/CGRAM)	37 us
Read data from RAM	1	1	D7	D6	D5	D4	D3	D2	D1	D0		Read data from internal RAM (DDRAM/CGRAM)	37 us

Note:

Be sure the ST7066U is not in the busy state (BF = 0) before sending an instruction from the MPU to the ST7066U. If an instruction is sent without checking the busy flag, the time between the first instruction and next instruction will take much longer than the instruction time itself. Refer to Instruction Table for the list of each instruction execution time.

FUNCTION DESCRIPTION

● **Clear Display**

	RS	RW	DB7	DB6	DB5	DB4	DB3	DB2	DB1	DB0
Code	0	0	0	0	0	0	0	0	0	1

Clear all the display data by writing "20H" (space code) to all DDRAM address, and set DDRAM address to "00H" into AC (address counter). Return cursor to the original status, namely, bring the cursor to the left edge on first line of the display. Make entry mode increment (I/D = "1").

● **Return Home**

	RS	RW	DB7	DB6	DB5	DB4	DB3	DB2	DB1	DB0
Code	0	0	0	0	0	0	0	0	1	x

Return Home is cursor return home instruction. Set DDRAM address to "00H" into the address counter. Return cursor to its original site and return display to its original status, if shifted. Contents of DDRAM does not change.

● **Entry Mode Set**

	RS	RW	DB7	DB6	DB5	DB4	DB3	DB2	DB1	DB0
Code	0	0	0	0	0	0	0	1	I/D	S

Set the moving direction of cursor and display.

- **I/D : Increment / decrement of DDRAM address (cursor or blink)**
 When I/D = "High", cursor/blink moves to right and DDRAM address is increased by 1.
 When I/D = "Low", cursor/blink moves to left and DDRAM address is decreased by 1.
 * CGRAM operates the same as DDRAM, when read from or write to CGRAM.
- **S: Shift of entire display**
 When DDRAM read (CGRAM read/write) operation or S = "Low", shift of entire display is not performed. If S = "High" and DDRAM write operation, shift of entire display is performed according to I/D value (I/D = "1" : shift left, I/D = "0" : shift right).

S	I/D	Description
H	H	Shift the display to the left
H	L	Shift the display to the right

FUNCTION DESCRIPTION(CONT.)

● Display ON/OFF

RS	RW	DB7	DB6	DB5	DB4	DB3	DB2	DB1	DB0
Code									
0	0	0	0	0	0	1	D	C	B

Control display/cursor/blink ON/OFF 1 bit register.

- **D : Display ON/OFF control bit**
 When D = "High", entire display is turned on.
 When D = "Low", display is turned off, but display data is remained in DDRAM.
- **C : Cursor ON/OFF control bit**
 When C = "High", cursor is turned on.
 When C = "Low", cursor is disappeared in current display, but I/D register remains its data.
- **B : Cursor Blink ON/OFF control bit**
 When B = "High", cursor blink is on, that performs alternate between all the high data and display character at the cursor position.
 When B = "Low", blink is off.

● Cursor or Display Shift

RS	RW	DB7	DB6	DB5	DB4	DB3	DB2	DB1	DB0
Code									
0	0	0	0	0	1	S/C	R/L	x	x

Without writing or reading of display data, shift right/left cursor position or display. This instruction is used to correct or search display data. During 2-line mode display, cursor moves to the 2nd line after 40th digit of 1st line. Note that display shift is performed simultaneously in all the line. When displayed data is shifted repeatedly, each line shifted individually. When display shift is performed, the contents of address counter are not changed.

S/C	R/L	Description	AC Value
L	L	Shift cursor to the left	AC=AC-1
L	H	Shift cursor to the right	AC=AC+1
H	L	Shift display to the left. Cursor follows the display shift	AC=AC
H	H	Shift display to the right. Cursor follows the display shift	AC=AC

● Function Set

RS	RW	DB7	DB6	DB5	DB4	DB3	DB2	DB1	DB0
Code									
0	0	0	0	1	DL	N	F	x	x

FUNCTION DESCRIPTION(CONT.)

- **DL : Interface data length control bit**
 When DL = "High", it means 8-bit bus mode with MPU.
 When DL = "Low", it means 4-bit bus mode with MPU. So to speak, DL is a signal to select 8-bit or 4-bit bus mode.
 When 4-bit bus mode, it needs to transfer 4-bit data by two times.
- **N : Display line number control bit**
 When N = "Low", it means 1-line display mode.
 When N = "High", 2-line display mode is set.
- **F : Display font type control bit**
 When F = "Low", it means 5 x 8 dots format display mode
 When F = "High", 5 x11 dots format display mode.

N	F	No. of Display Lines	Character Font	Duty Factor
L	L	1	5x8	1/8
L	H	1	5x11	1/11
H	x	2	5x8	1/16

● **Set CGRAM Address**

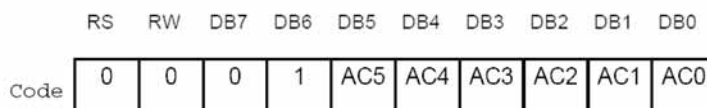

Set CGRAM address to AC.
 This instruction makes CGRAM data available from MPU.

● **Set DDRAM Address**



Set DDRAM address to AC.
 This instruction makes DDRAM data available from MPU.
 When 1-line display mode (N = 0), DDRAM address is from "00H" to "4FH".
 In 2-line display mode (N = 1), DDRAM address in the 1st line is from "00H" to "27H", and
 DDRAM address in the 2nd line is from "40H" to "67H".

FUNCTION DESCRIPTION(CONT.)

- **Read Busy Flag and Address**



When BF = "High", indicates that the internal operation is being processed. So during this time the next instruction cannot be accepted.

The address Counter (AC) stores DDRAM/CGRAM addresses, transferred from IR.

After writing into (reading from) DDRAM/CGRAM, AC is automatically increased (decreased) by 1.

- **Write Data to CGRAM or DDRAM**

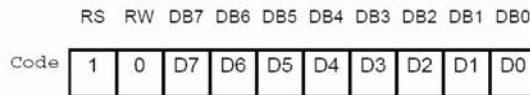

Write binary 8-bit data to DDRAM/CGRAM.

The selection of RAM from DDRAM, CGRAM, is set by the previous address set instruction : DDRAM address set, CGRAM address set. RAM set instruction can also determine the AC direction to RAM.

After write operation, the address is automatically increased/decreased by 1, according to the entry mode.

- **Read Data from CGRAM or DDRAM**

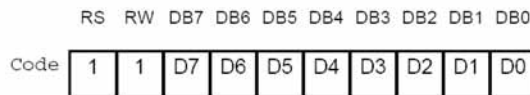

Read binary 8-bit data from DDRAM/CGRAM.

The selection of RAM is set by the previous address set instruction. If address set instruction of RAM is not performed before this instruction, the data that read first is invalid, because the direction of AC is not determined. If you read RAM data several times without RAM address set instruction before read operation, you can get correct RAM data from the second, but the first data would be incorrect, because there is no time margin to transfer RAM data.

In case of DDRAM read operation, cursor shift instruction plays the same role as DDRAM address set instruction : it also transfer RAM data to output data register. After read operation address counter is automatically increased/decreased by 1 according to the entry mode. After CGRAM read operation, display shift may not be executed correctly.

* In case of RAM write operation, after this AC is increased/decreased by 1 like read operation. In this time, AC indicates the next address position, but you can read only the previous data by read instruction.

**DISPLAY DD RAM AND CHARACTER POSITION**

20x4, 1/16 DUTY CYCLE

	1	2		20	DISPLAY POSITION DD RAM ADDRESS
line 1	00	01	13	
line 2	40	41	53	
line 3	14	15	27	
line 4	54	55	67	

TIMING CHARACTERISTICS OF COMPATIBLE CONTROLLER CHIPS

TA = 25°C, VCC = 5V

<i>Write Mode (Writing data from MPU to ST7066U)</i>						
T _C	Enable Cycle Time	Pin E	1200	-	-	ns
T _{PW}	Enable Pulse Width	Pin E	140	-	-	ns
T _R , T _F	Enable Rise/Fall Time	Pin E	-	-	25	ns
T _{AS}	Address Setup Time	Pins: RS,RW,E	0	-	-	ns
T _{AH}	Address Hold Time	Pins: RS,RW,E	10	-	-	ns
T _{DSW}	Data Setup Time	Pins: DB0 - DB7	40	-	-	ns
T _H	Data Hold Time	Pins: DB0 - DB7	10	-	-	ns
<i>Read Mode (Reading Data from ST7066U to MPU)</i>						
T _C	Enable Cycle Time	Pin E	1200	-	-	ns
T _{PW}	Enable Pulse Width	Pin E	140	-	-	ns
T _R , T _F	Enable Rise/Fall Time	Pin E	-	-	25	ns
T _{AS}	Address Setup Time	Pins: RS,RW,E	0	-	-	ns
T _{AH}	Address Hold Time	Pins: RS,RW,E	10	-	-	ns
T _{DDR}	Data Setup Time	Pins: DB0 - DB7	-	-	100	ns
T _H	Data Hold Time	Pins: DB0 - DB7	10	-	-	ns

Write Mode Timing Diagram (Writing Data from MPU to ST7066U)

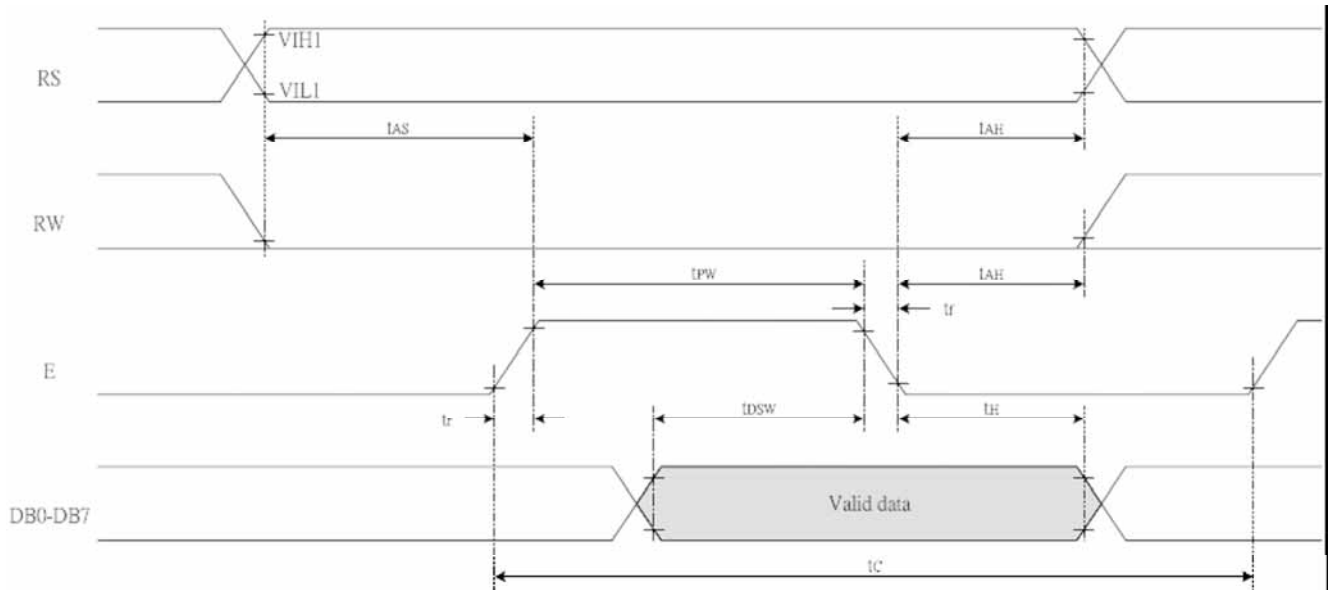

Read Mode Timing Diagram (Reading Data from ST7066U to MPU)

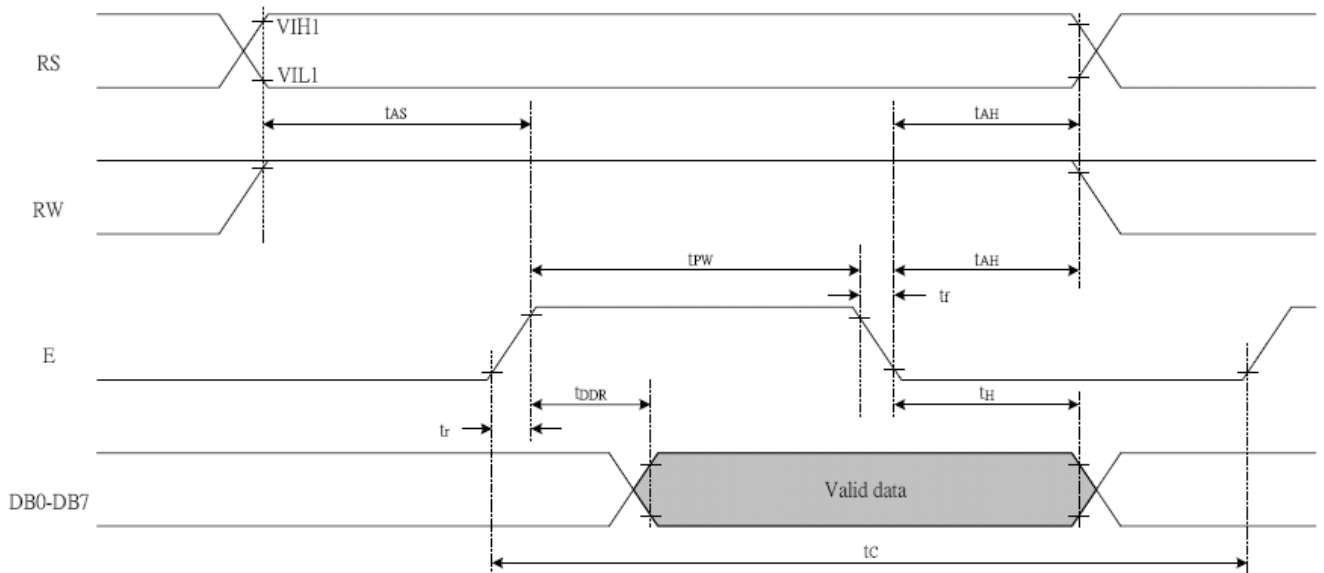



THE RESET CIRCUIT

An internal reset circuit automatically initializes the ST7066U when the power is turned on. The following instructions are executed during the initialization. The busy flag (BF) is kept in the busy state until the initialization ends (BF = 1). The busy state lasts for 40 ms after VCC rises to 4.5 V.

1. Display clear
2. Function set:
 - DL = 1; 8-bit interface data
 - N = 0; 1-line display
 - F = 0; 5x8 dot character font
3. Display on/off control:
 - D = 0; Display off
 - C = 0; Cursor off
 - B = 0; Blinking off
4. Entry mode set:
 - I/D = 1; Increment by 1
 - S = 0; No shift

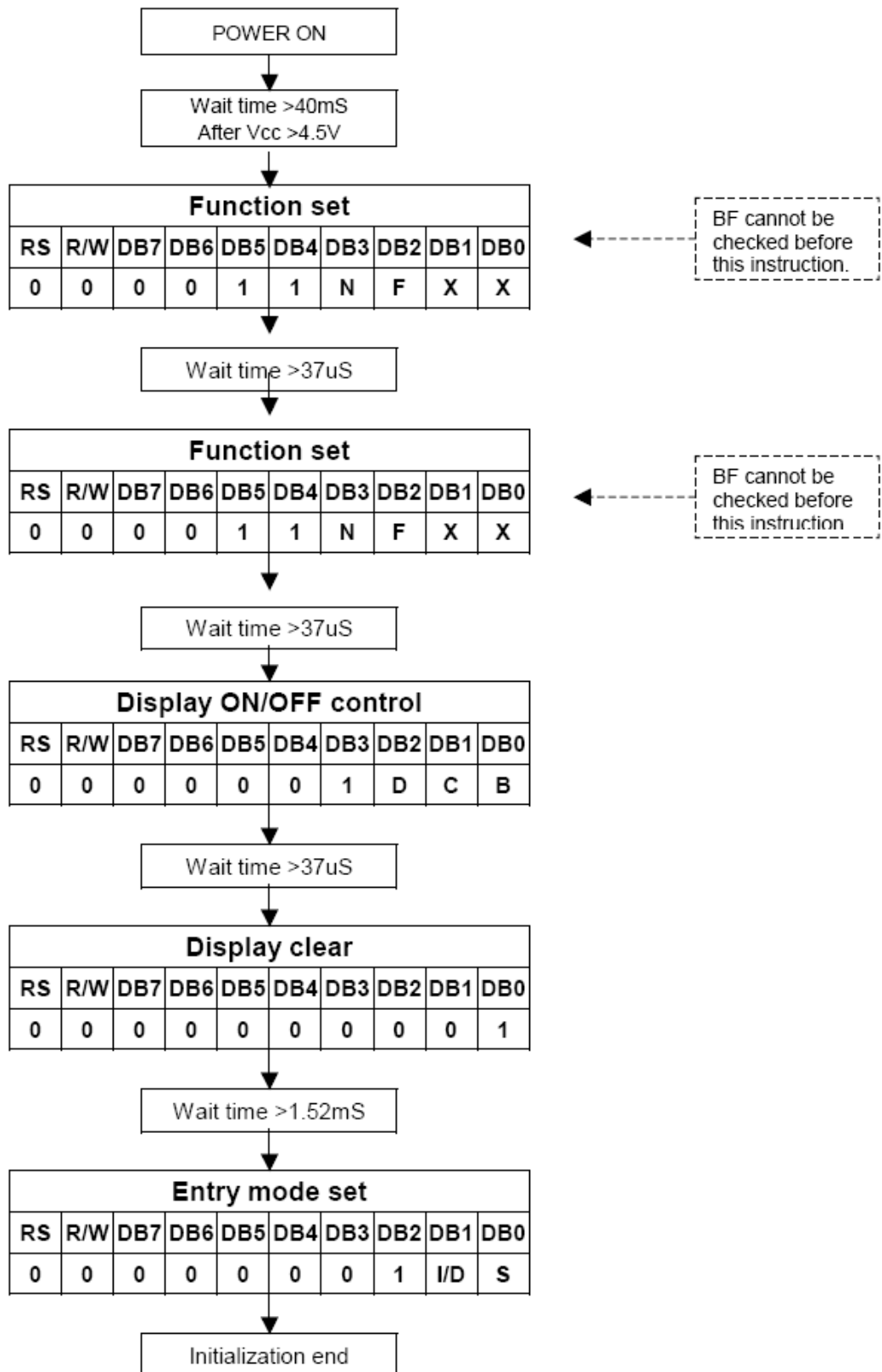
Initialization for 8-Bit Interface

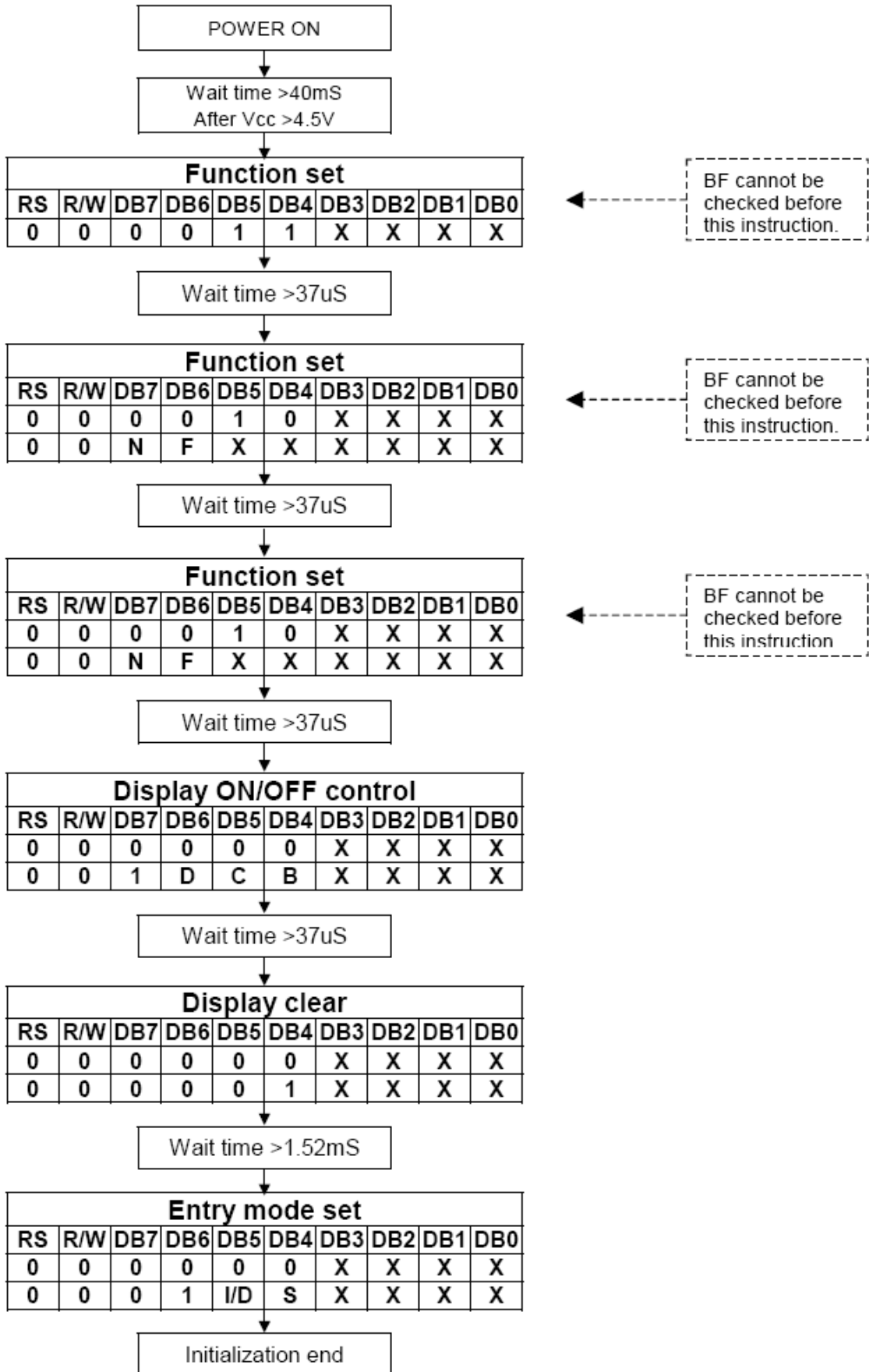
Initialization for 4-Bit Interface

**ELECTRO-OPTICAL CHARACTERISTICS**

MEASURING CONDITION: POWER SUPPLY = $V_{OP} / 64 \text{ Hz}$
 TEMPERATURE = $23 \pm 5 \text{ }^\circ\text{C}$
 RELATIVE HUMIDITY = $60 \pm 20 \%$

ITEM	SYMBOL	UNIT	TYP. STN
RESPONSE TIME	Ton	ms	150
	Toff	ms	190
CONTRAST RATIO	Cr	-	15
VIEWING ANGLE (6 O'clock) (Cr \geq 10)	V3:00	$^\circ$	45
	V6:00	$^\circ$	70
	V9:00	$^\circ$	45
	V12:00	$^\circ$	60

THE ELECTRO-OPTICAL CHARACTERISTICS ARE MEASURED VALUE BUT NOT GUARANTEED ONES

RELIABILITY OF LCD MODULE

ITEM	TEST CONDITION FOR NORMAL TEMPERATURE	TEST CONDITION FOR WIDE TEMPERATURE	TIME
High temperature operating	50 $^\circ\text{C}$	70 $^\circ\text{C}$	240 hours
Low temperature operating	0 $^\circ\text{C}$	-20 $^\circ\text{C}$	240 hours
High temperature storage	60 $^\circ\text{C}$	80 $^\circ\text{C}$	240 hours
Low temperature storage	-10 $^\circ\text{C}$	-30 $^\circ\text{C}$	240 hours
Temperature-humidity storage	40 $^\circ\text{C}$ 90% R.H.	60 $^\circ\text{C}$ 90% R.H.	96 hours
Temperature cycling	-10 $^\circ\text{C}$ to 60 $^\circ\text{C}$ 30 Min Dwell	-30 $^\circ\text{C}$ to 80 $^\circ\text{C}$ 30 Min Dwell	5 cycles
Vibration Test at LCM Level	Freq 10-55 Hz Sweep rate: 10-55-10 at 1 min Sweep mode Linear Displacement: 2 mm p-p 1 Hour each for X, Y, Z	Freq 10-55 Hz Sweep rate: 10-55-10 at 1 min Sweep mode Linear Displacement: 2 mm p-p 1 Hour each for X, Y, Z	—

**QUALITY STANDARD OF LCD MODULE**

1.0	Sampling Method		
	Sampling Plan : MIL STD 105 E Class of AQL : Level II/Single Sampling Critical : 0.25% Major 0.65% Minor 1.5%		
2.0	Defect Group	Failure Category	Failure Reasons
	Critical Defect 0.25%(AQL)	Malfunction	Open Short Burnt or dead component Missing part/improper part P.C.B. Broken
	Major Defect 0.65%(AQL)	Poor Insulation	Potential short High current Component damage or scratched or Lying too close improper coating
		Poor Conduction	Damage joint Wrong polarity Wrong spec. part Uneven/intermittent contact Loose part Copper peeling Rust or corrosion or dirt's
	Minor Defect 1.5%(AQL)	Cosmetic Defect	Minor scratch Flux residue Thin solder Poor plating Poor marking Crack solder Poor bending Poor packing Wrong size



HANDLING PRECAUTIONS

(1) CAUTION OF LCD HANDLING & CLEANING

The polarizing plate on the surface of the panel is made from organic substances. Be very careful for chemicals not to touch the plate or it leads the polarizing plate to deteriorate.

If the use of a chemical is unavoidable, wipe the panel lightly with soft materials, such as gauze and absorbent cotton, soaked in a solvent.

*Usable solvent: Alcohol (ethanol, IPA and the like)

*Appropriate solvent: Ketones, ethyl alcohol

Avoid wiping with a dry cloth, since it could damage the surface of the polarizing plate and others.

(2) CAUTION AGAINST STATIC CHARGE

The LCD modules use CMOS LSI drivers, so customers are recommended that any unused input terminal would be connected to V_{DD} or V_{SS} , do not input any signals before power is turned on, and ground your body, work/assembly areas, assembly equipment to protect against static electricity.

(3) PACKAGING

Avoid intense shock and falls from a height and do not operate or store them exposed to direct sunshine or high temperature/humidity for long periods.

(4) CAUTION FOR OPERATION

The viewing angle can be adjusted by varying the LCD driving voltage V_O .

Driving voltage should be kept within specified range, excess voltage shortens display life.

Response time increases with decrease in temperature.

Display may turn black or dark Blue at temperature above its operational range; this is however not destructive and the display will return to normal once the temperature falls back to range.

Mechanical disturbance during operation (such as pressing on the viewing area) may cause the segments to appear "fractured". They will recover once the display is turned off.

Condensation at terminals will cause malfunction and possible electrochemical reaction. Relative humidity of the environment should therefore be kept below 60%.

(5) SAFETY

Liquid crystal may leak out of a damaged LCD, it is recommended to wash off the liquid crystal by using solvents such as acetone or ethanol and should be burned up later.

If any liquid leaks out of a damaged glass cell comes in contact with your hands, wash it off with soap and water immediately.

WARRANTY

Multi-Inno will replace or repair any of her LCD module in accordance with her LCD specification for a period of one year from date of shipment. The warranty liability of Multi-Inno is limited to repair and/or replacement. Multi-Inno will not be responsible for any subsequent or consequential event.