



MULTI-INNO TECHNOLOGY CO., LTD.

www.multi-inno.com

LCD MODULE SPECIFICATION

Model : MI1020BT-1

For Customer's Acceptance:

Customer	
Approved	
Comment	

Revision	1.0
Engineering	
Date	2009-03-26
Our Reference	

CONTENTS

- GENERAL INFORMATION
- EXTERNAL DIMENSIONS
- ABSOLUTE MAXIMUM RATINGS
- ELECTRICAL CHARACTERISTICS
- CURRENT CONSUMPTION
- BACKLIGHT CHARACTERISTICS
- ELECTRO-OPTICAL CHARACTERISTICS
- INTERFACE DESCRIPTION
- APPLICATION NOTES
- RELIABILITY TEST
- INSPECTION CRITERION
- PRECAUTIONS FOR USING LCD MODULES
- PRIOR CONSULT MATTER

■ GENERAL INFORMATION

Item	Contents	Unit
LCD type	TFT/Transmissive/Normally white	/
Size	10.2	Inch
Viewing direction	12:00	O' Clock
Gray scale inversion direction	6:00	O' Clock
LCM (W × H × D)	235.00×145.80×6.10	mm ³
Active area (W×H)	222.00×132.48	mm ²
Dot pitch (W×H)	0.0925×0.276	mm ²
Number of dots	800 (RGB) × 480	/
Backlight type	30 LEDs	/
Interface type	RGB 18 bits	/
Color depth	262K	/
Color arrangement	RGB-stripe	/
Surface treatment	Anti-glare	/
Backlight power consumption	1.86	W
Panel power consumption	0.25	W
Input voltage	3.3	V
With/Without TSP	Without TSP	/
Weight	TBD	g

Note 1:Viewing direction for best image quality is different from TFT definition, there is a 180 degree shift.

Note 2 : RoHS compliant;

Note 3: LCM weight tolerance: ± 5% .

EXTERNAL DIMENSIONS

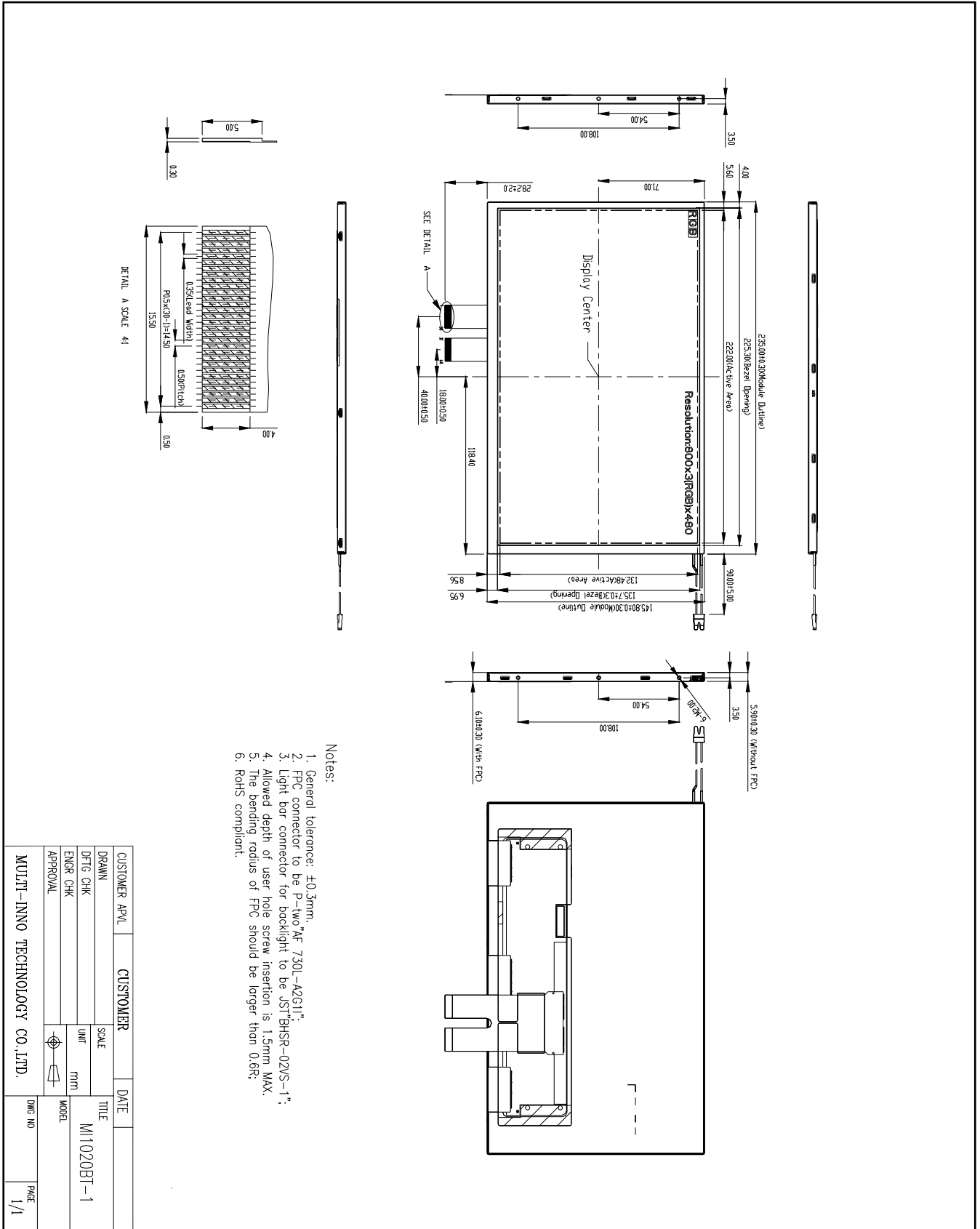

■ ABSOLUTE MAXIMUM RATINGS

Parameter	Symbol	Min	Max	Unit
Power voltage	VCC	-0.3	5.0	V
	AVDD	-0.5	12.0	V
	VGH	13.0	18.0	V
	VGL	-15.0	0.3	V
	VGH-VGL	-	33.0	V
Input signal voltage	V1~V7	0.4AVDD	AVDD-0.1	V
	V8~V14	-0.3	0.6AVDD	V
LED reverse voltage(each LED)	V _R	-	1.2	V
LED forward current(each LED)	I _F	-	25	mA
Operating temperature	T _{OP}	-30	85	°C
Storage temperature	T _{ST}	-30	85	°C
Humidity	RH	-	90%(Max60°C)	RH

Note 1: $AV_{DD} - 0.1 \geq V1 \geq V2 \geq V3 \geq V4 \geq V5 \geq V6 \geq V7 \geq V8 \geq V9 \geq V10 > V11 \geq V12 \geq V13 \geq V14 \geq AVSS + 0.1$

Note 2: The absolute maximum rating values of the module should not be exceeded. Once exceeded absolute maximum rating values, the characteristics of the module may not be recovered. Even in an extreme condition, may result in module permanently destroyed.

Note 3: Vr conditions: Zener Diode 20mA.

■ ELECTRICAL CHARACTERISTICS

DC CHARACTERISTICS

Parameter	Symbol	Min	Typ	Max	Unit
Power voltage	VCC	3.0	3.3	3.6	V
	AVDD	9.0	9.2	9.4	V
	VGH	14.3	15.0	15.7	V
	VGL	-10.5	-10.0	-9.5	V
Input signal voltage	V _{com}	3.6	3.8	4.0	V
	V1~V7	0.4AVDD	-	AVDD-0.1	V
	V8~V14	0.1	-	0.6AVDD	V
Input voltage 'H' level	V _{IH}	0.7VCC	-	VCC	V
Input voltage 'L' level	V _{IL}	0	-	0.3VCC	V

Note 1: Be sure to apply GND, V_{CC}, and V_{GL}, to the LCD first, and then apply V_{GH}.

■ CURRENT CONSUMPTION

Item	Symbol	Min.	Typ.	Max.	Unit	Condition
Current for driver	IGH	-	0.3	0.5	mA	VGH=15V
	IGL	-	0.2	1.0	mA	VGL=-10V
	ICC	-	4.0	10	mA	VCC=3.3V
	IAVDD	-	25	50	mA	AVDD=9.2V

■ BACKLIGHT CHARACTERISTICS

Item	Symbol	Min.	Typ.	Max.	Unit	Condition
LED forward voltage	V_L	8.4	9.3	10.5	V	Note 1
LED forward current	I_L	180	200	220	mA	
LED life time	-	20,000	-	-	Hrs	Note 2

Note 1: The LED Supply Voltage is defined by the number of LED at $T_a=25^{\circ}\text{C}$ and $I_L=200\text{mA}$.

Note 2: The "LED life time" is defined as the module brightness decrease to 50% original brightness at $T_a=25^{\circ}\text{C}$ and $I_L=200\text{mA}$. The LED lifetime could be decreased if operating I_L is larger than 200 mA.

■ELECTRO-OPTICAL CHARACTERISTICS

Item	Symbol	Condition	Min	Typ	Max	Unit	Remark	Note
Response time	Tr+Tf	$\theta=0^\circ$ $\varnothing=0^\circ$ $T_a=25^\circ\text{C}$	-	35	70	ms	FIG 1.	4
Contrast ratio	Cr		250	300	-	---	FIG 2.	1
Luminance uniformity	δ WHITE		70	75	-	%	FIG 2.	3
Surface Luminance	Lv		200	250	-	cd/m ²	FIG 2.	2
Viewing angle range	θ	$\varnothing = 90^\circ$	35	45	-	deg	FIG 3.	6
		$\varnothing = 270^\circ$	55	65	-	deg	FIG 3.	
		$\varnothing = 0^\circ$	55	65	-	deg	FIG 3.	
		$\varnothing = 180^\circ$	55	65	-	deg	FIG 3.	
CIE (x, y) chromaticity	Red	x	-	-	-	FIG 2.	5	
		y	-	-	-			
	Green	x	-	-	-			
		y	-	-	-			
	Blue	x	-	-	-			
		y	-	-	-			
	White	x	0.26	0.31	0.36			
		y	0.28	0.33	0.38			

Note 1. Contrast Ratio(CR) is defined mathematically as For more information see FIG 2.

$$\text{Contrast Ratio} = \frac{\text{Average Surface Luminance with all white pixels (P1, P2, P3, P4, P5)}}{\text{Average Surface Luminance with all black pixels (P1, P2, P3, P4, P5)}}$$

Note 2. Surface luminance is the LCD surface from the surface with all pixels displaying white. For more information see FIG 2.

$$L_v = \text{Average Surface Luminance with all white pixels (P1, P2, P3, P4, P5)}$$

Note 3. The uniformity in surface luminance , δ WHITE is determined by measuring luminance at each test position 1 through 5, and then dividing the maximum luminance of 5 points luminance by minimum luminance of 5 points luminance. For more information see FIG 2.

$$\delta \text{ WHITE} = \frac{\text{Minimum Surface Luminance with all white pixels (P1, P2, P3, P4, P5)}}{\text{Maximum Surface Luminance with all white pixels (P1, P2, P3, P4, P5)}}$$

Note 4. Response time is the time required for the display to transition from White to black(Rise Time, Tr) and from black to white(Decay Time, Tf). For additional information see FIG 1. The test equipment is Autronic-Melchers's ConoScope. Series.

Note 5. CIE (x, y) chromaticity, The x, y value is determined by measuring luminance at each test position 1 through 5, and then make average value.

Note 6. Viewing angle is the angle at which the contrast ratio is greater than 2. For TFT module the contrast ratio is greater than 10. The angles are determined for the horizontal or x axis and the vertical or y axis with respect to the z axis which is normal to the LCD surface. For more information see FIG 3.

Note 7. For viewing angle and response time testing, the testing data is base on Autronic-Melchers's ConoScope. Series Instruments For contrast ratio, Surface Luminance, Luminance uniformity, CIE The test data is base on TOPCON's BM-5 photo detector.

FIG. 1 The definition of Response Time

The response time is defined as the following figure and shall be measured by switching the input signal for “black” and “white”.

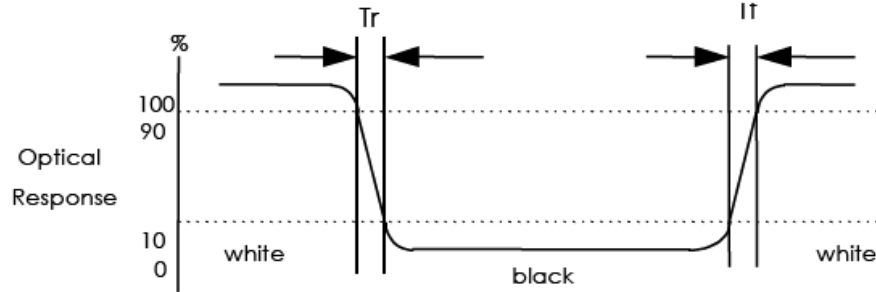

FIG. 2 Measuring method for Contrast ratio, surface luminance, Luminance uniformity , CIE (x, y) chromaticity

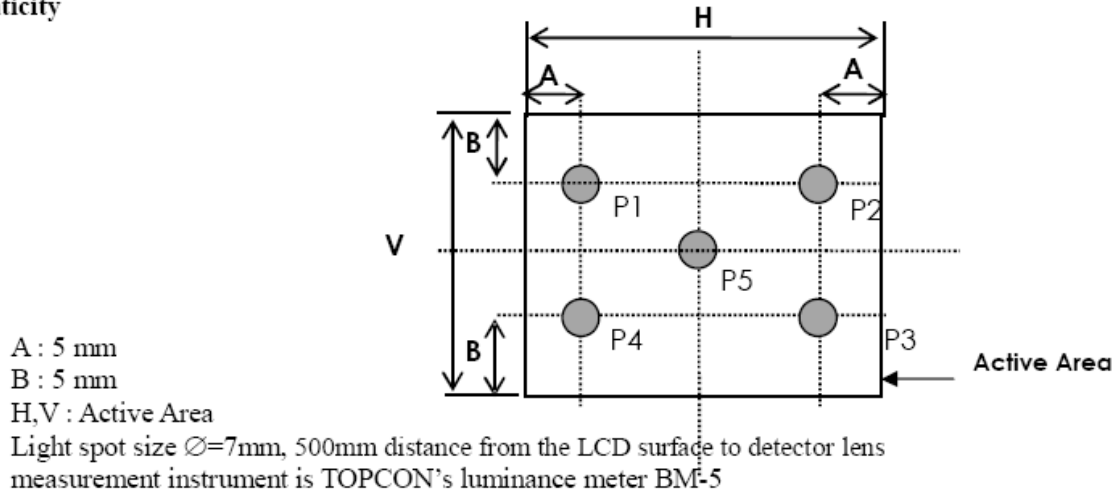
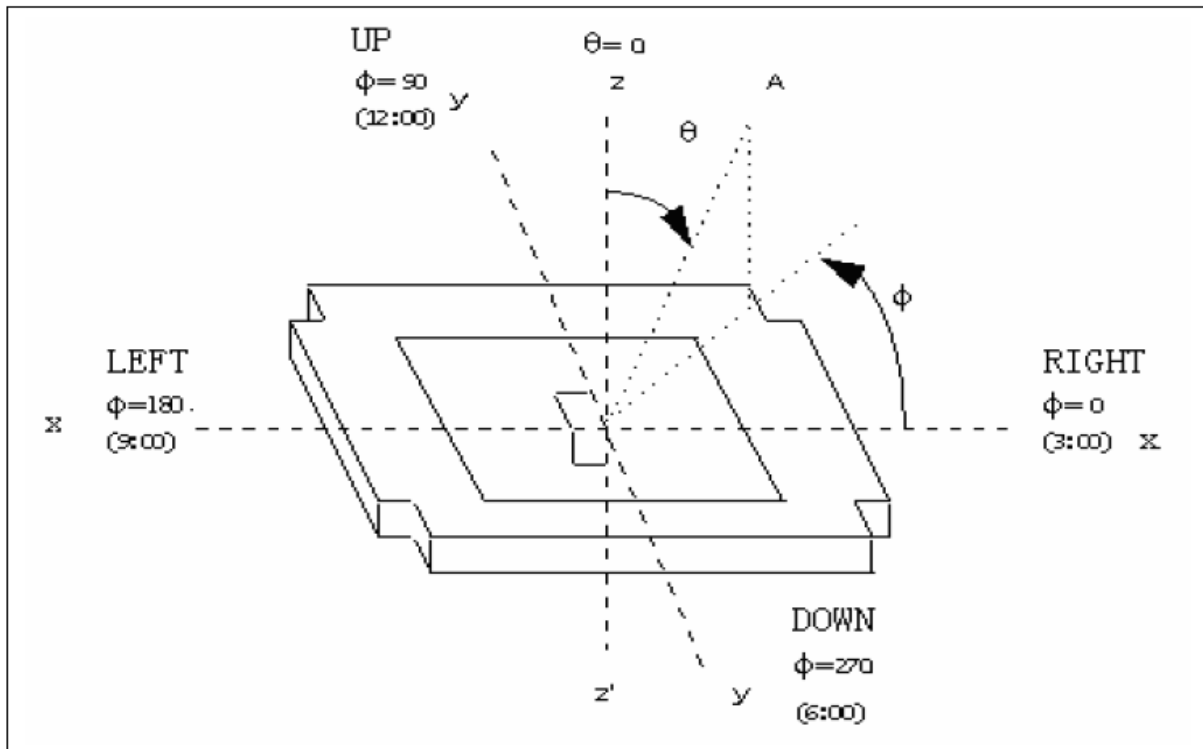

FIG. 3 The definition of viewing angle



■ INTERFACE DESCRIPTION

1. TFT LCD Panel Driving Section

FPC connector is used for the module electronics interface. The recommended model is "AF 730L-A2G1T" manufactured by P-TWO.

Pin No.	Symbol	I/O	Function	Remark
1	POL	I	Polarity selection	
2	STVD	I/O	Vertical start pulse input when U/D= H	Note 1
3	OEV	I	Output enable	
4	CKV	I	Vertical clock	
5	STVU	I/O	Vertical start pulse input when U/D= L	Note 1
6	GND	P	Power ground	
7	EDGSL	I	Select rising edge or rising/falling edge	
8	V _{CC}	P	Power supply for digital circuit	
9	V ₉	I	Gamma voltage level 9	
10	V _{GL}	P	Gate OFF voltage	
11	V ₂	I	Gamma voltage level 2	
12	V _{GH}	P	Gate ON voltage	
13	V ₆	I	Gamma voltage level 6	
14	U/D	I	Up/down selection	Note 1,2
15	V _{COM}	I	Common voltage	
16	GND	P	Power ground	
17	AV _{DD}	P	Power supply for analog circuit	
18	V ₁₄	I	Gamma voltage level 14	
19	V ₁₁	I	Gamma voltage level 11	
20	V ₈	I	Gamma voltage level 8	
21	V ₅	I	Gamma voltage level 5	
22	V ₃	I	Gamma voltage level 3	
23	GND	P	Power ground	
24	R ₅	I	Red data(MSB)	
25	R ₄	I	Red data	
26	R ₃	I	Red data	
27	R ₂	I	Red data	
28	R ₁	I	Red data	

29	R0	I	Red data(LSB)	
30	GND	P	Power ground	
31	GND	P	Power ground	
32	G5	I	Green data(MSB)	
33	G4	I	Green data	
34	G3	I	Green data	
35	G2	I	Green data	
36	G1	I	Green data	
37	G0	I	Green data(LSB)	
38	STHL	I/O	Horizontal start pulse input when R/L = L	Note 1
39	REV	P	Control signal are inverted or not	Note 3
40	GND	I	Power ground	
41	DCLK	I	Sample clock	
42	V _{CC}	P	Power supply for digital circuit	
43	STHR	I/O	Horizontal start pulse input when R/L = H	Note 1
44	LD	I	Latches the polarity of outputs and switches the new data to outputs	
45	B5	I	Blue data (MSB)	
46	B4	I	Blue data	
47	B3	I	Blue data	
48	B2	I	Blue data	
49	B1	I	Blue data	
50	B0	I	Blue data (LSB)	
51	R/L	I	Right/ left selection	Note 1,2
52	V1	I	Gamma voltage level 1	
53	V4	I	Gamma voltage level 4	
54	V7	I	Gamma voltage level 7	
55	V10	I	Gamma voltage level 10	
56	V12	I	Gamma voltage level 12	
57	V13	I	Gamma voltage level 13	
58	AV _{DD}	P	Voltage for analog circuit	
59	GND	P	Power ground	
60	V _{COM}	I	Common voltage	

I: input, O: output, P: Power

Note 1: Selection of scanning mode

Setting of scan control input		IN/OUT state for start pulse				Scanning direction
U/D	R/L	STVD	STVU	STHR	STHL	
GND	V _{CC}	O	I	I	O	Up to down, left to right
V _{CC}	GND	I	O	O	I	Down to up, right to left
GND	GND	O	I	O	I	Up to down, right to left
V _{CC}	V _{CC}	I	O	I	O	Down to up, left to right

Note 2: Definition of scanning direction.

Refer to the figure as below:

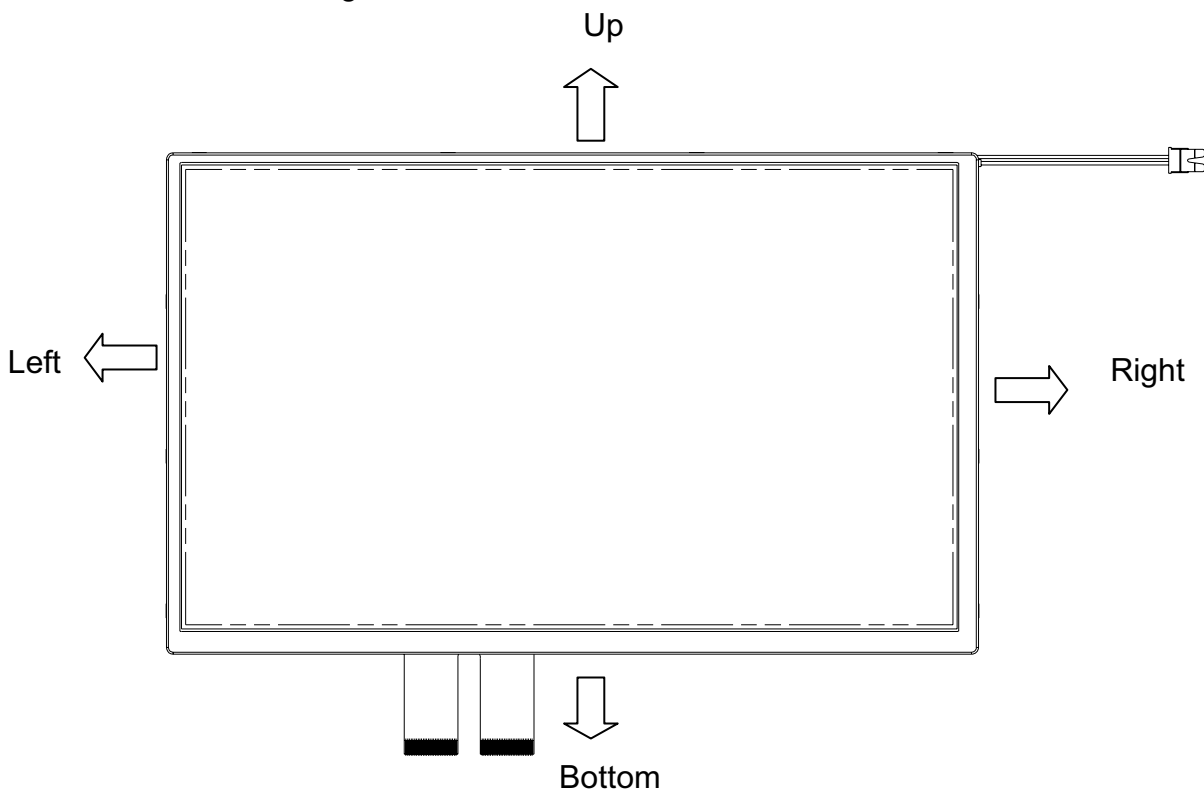

Note 3: When REV="L" , normally

REV="H", these data will be inverted.

2. Backlight Unit Section

LED Light Bar connector is used for the the integral backlight system. The recommended model is "BHSR-02VS-1" manufactured by JST.

Pin No.	Symbol	I/O	Function	Remark
1	V _{LED+}	P	Power for LED backlight anode	Pink
2	V _{LED-}	P	Power for LED backlight cathode	Black

■ APPLICATION NOTES

1. Timing Characteristics

1.1 Timing Conditions

Item	Symbol	Values			Unit	Remark
		Min.	Typ.	Max.		
DCLK frequency	F_{dclk}	-	40	45	MHz	
DCLK cycle	T_{cph}	22	25	-	ns	
DCLK pulse width	T_{cw}	8	-	-	ns	
Data set-up time	T_{su}	4	-	-	ns	
Data hold time	T_{hd}	2	-	-	ns	
Time that the last data to LD	T_{ld}	1	-	-	Tcph	
Pulse width of LD	T_{wld}	2	-	-	Tcph	
Time that LD to STHL/R	T_{lds}	5	-	-	Tcph	
POL set-up time	T_{psu}	6	-	-	ns	
POL hold time	T_{phd}	6	-	-	ns	
CKV frequency	F_{vclk}	-	-	200	KHz	
CKV rise time	T_{rck}	-	-	100	ns	
CKV falling time	T_{fck}	-	-	100	ns	
CKV pulse width	P_{WCLK}	500	-	-	ns	
Horizontal display timing range	T_{dh}	-	800	-	Tcph	
Horizontal timing range	T_h	-	1056	-	Tcph	
STVU/D setup time	T_{suv}	200	-	-	ns	
STVU/D hold time	T_{hdv}	300	-	-	ns	
STVU/D delay time	T_{dt}	-	-	500	ns	
Driver output delay time	T_{do}	-	-	900	ns	
Output rise time	T_{th}	-	500	1000	ns	
Output falling time	T_{thl}	-	400	800	ns	
OEV pulse width	T_{wcl}	1	-	-	us	
OEV to Driver output delay time	T_{oe}	-	-	900	ns	
Horizontal lines per field	T_v	512	525	610	Line	
Vertical display timing range	T_{vd}	-	480	-	Line	

1.2 Timing Diagram

Timing Diagram1

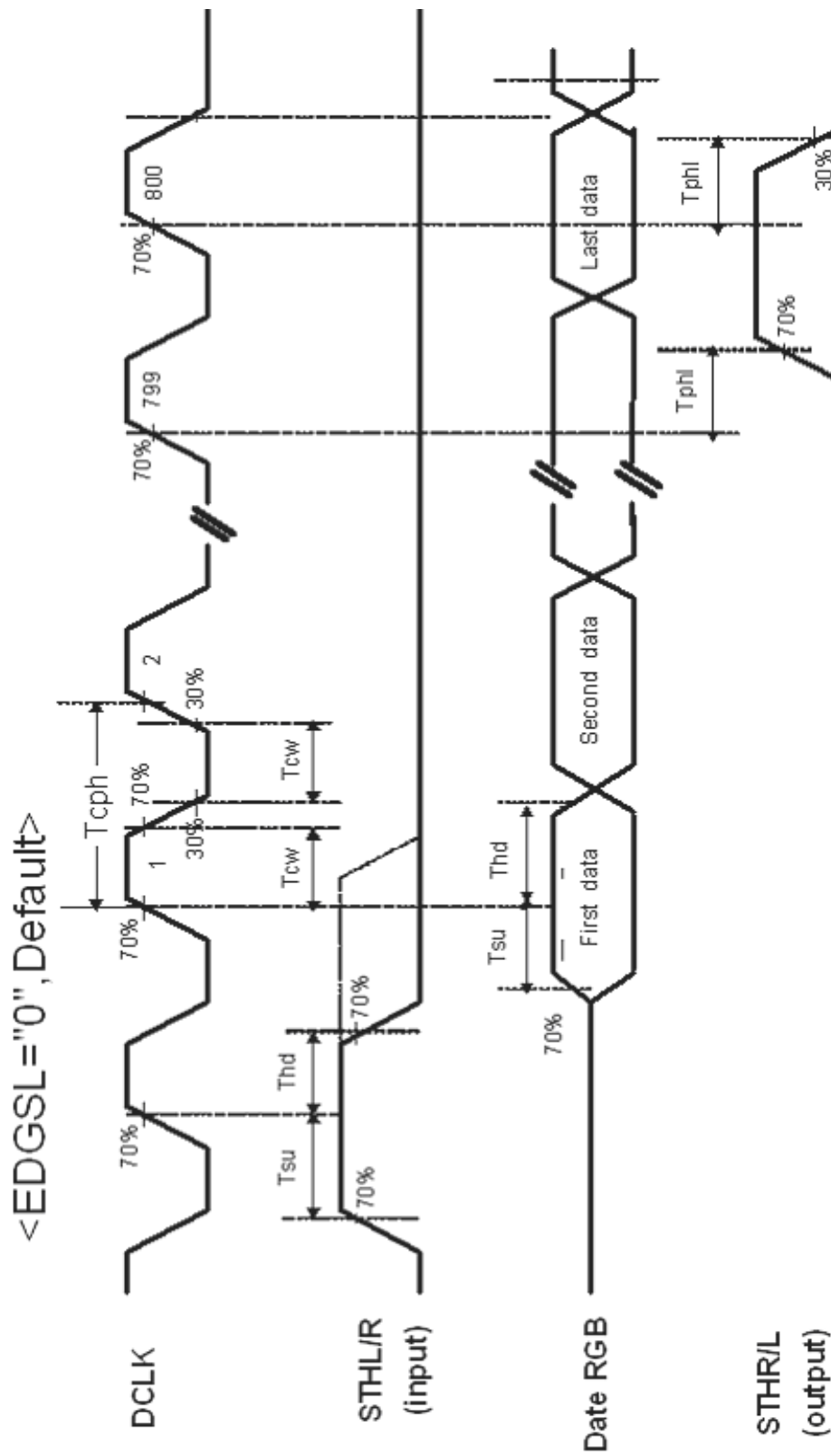

Fig.3-1 operation model 1

< EDGSL = "1" >

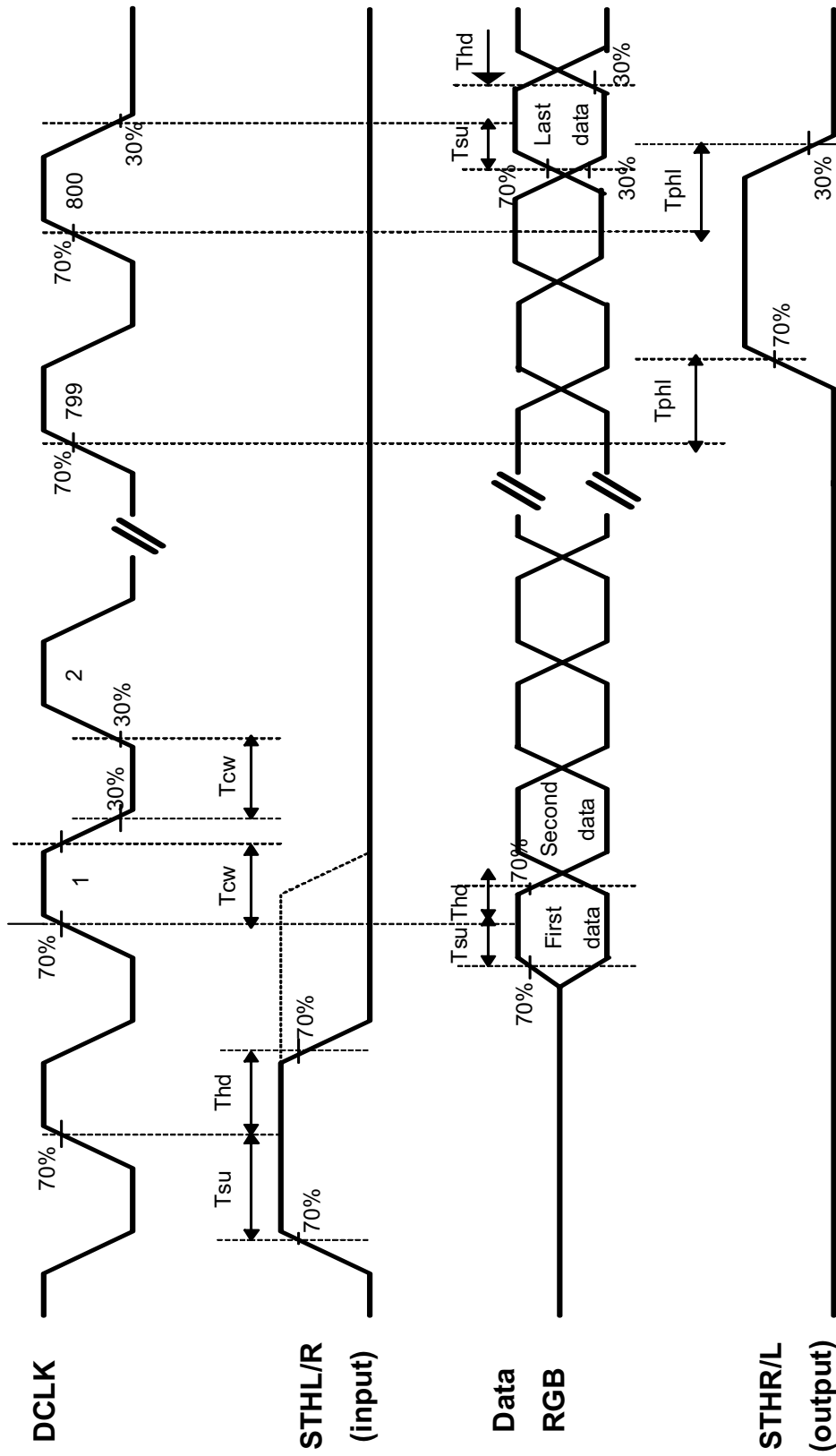

Fig.3-2 operation model 2

Timing Diagram 2

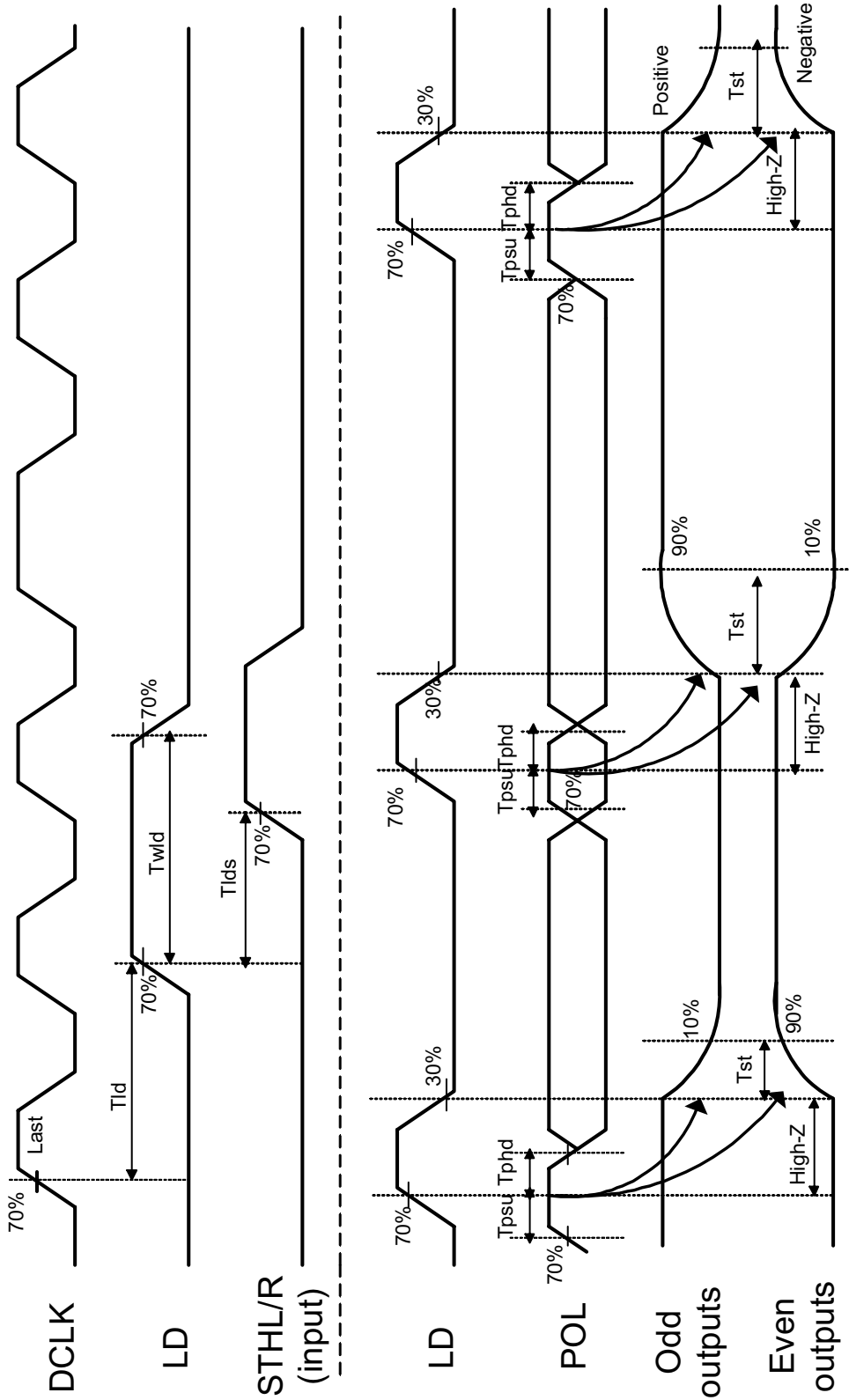

Fig.3-3 Horizontal timing 1

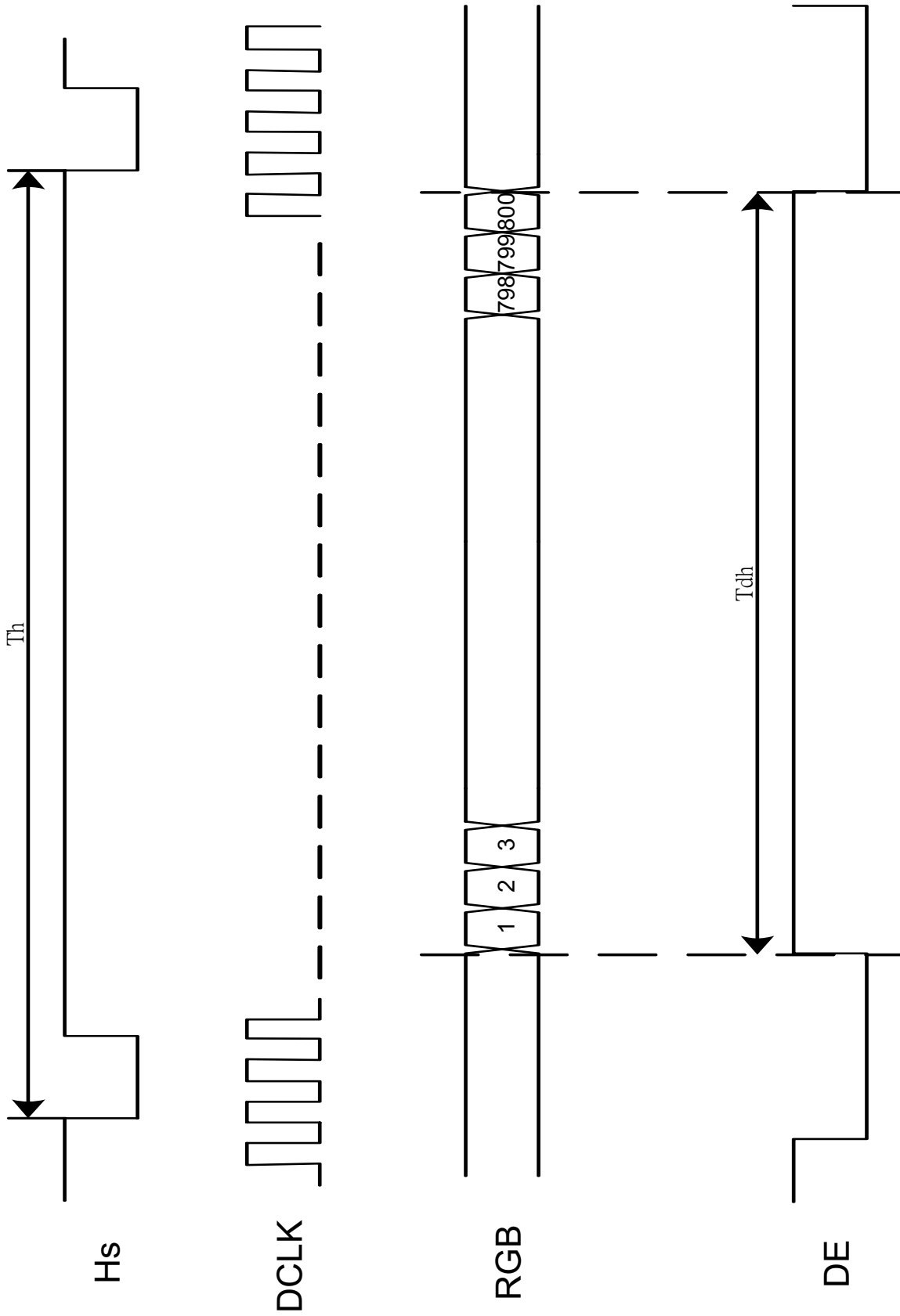

Fig.3-4 Horizontal timing 2

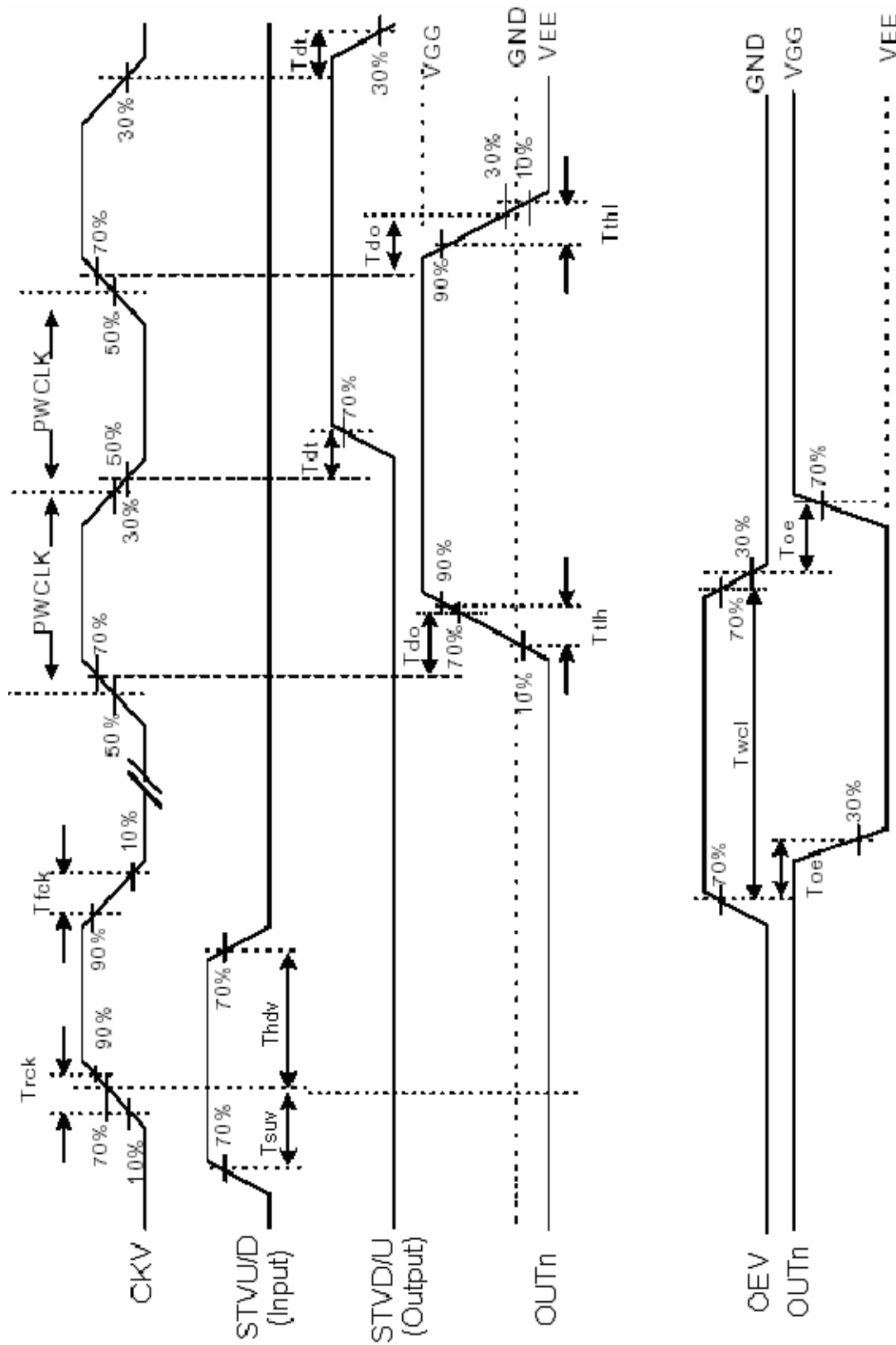

Fig.3-5 Vertical shift clock timing

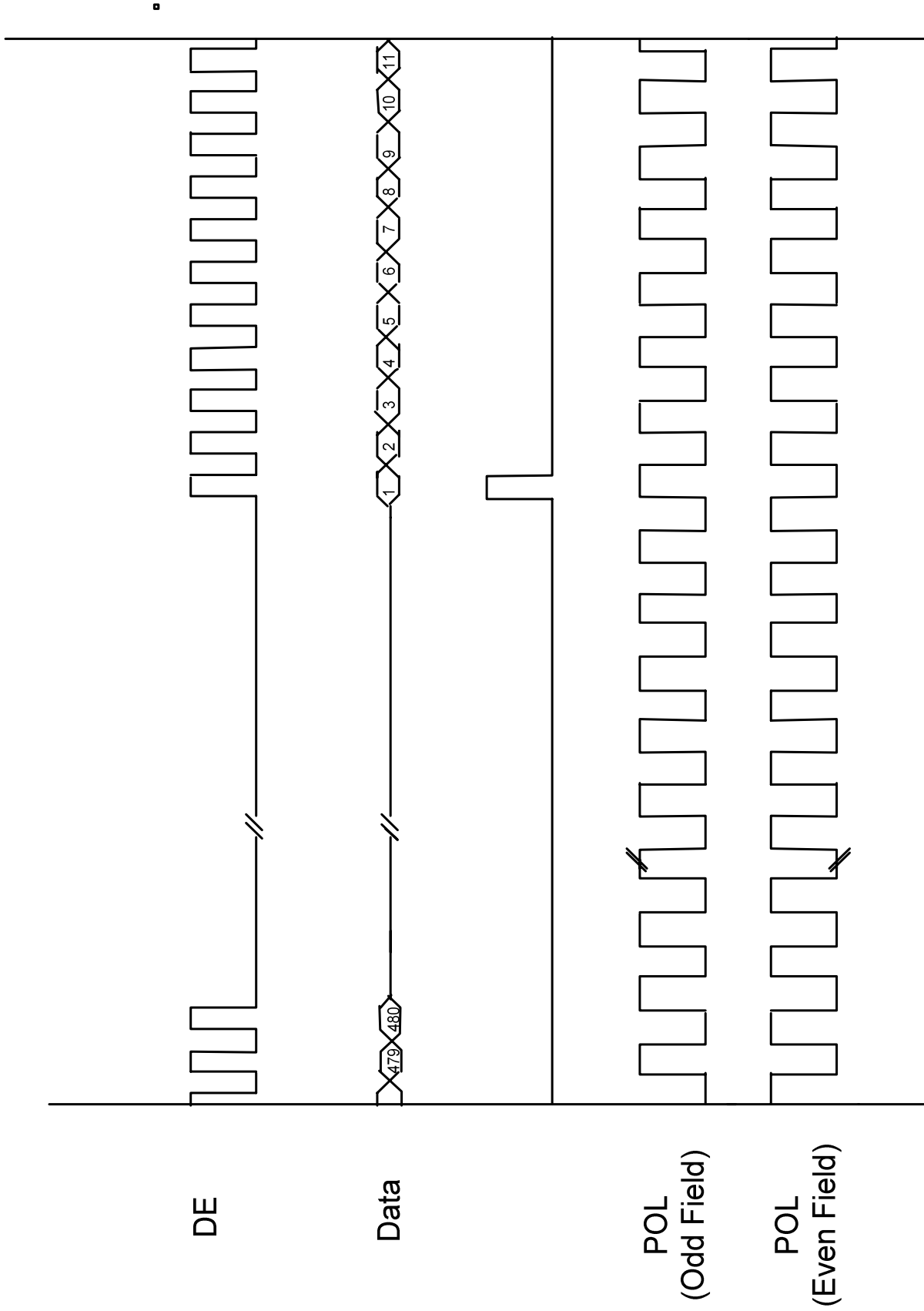

Fig.3-6 Vertical timing (from up to down)

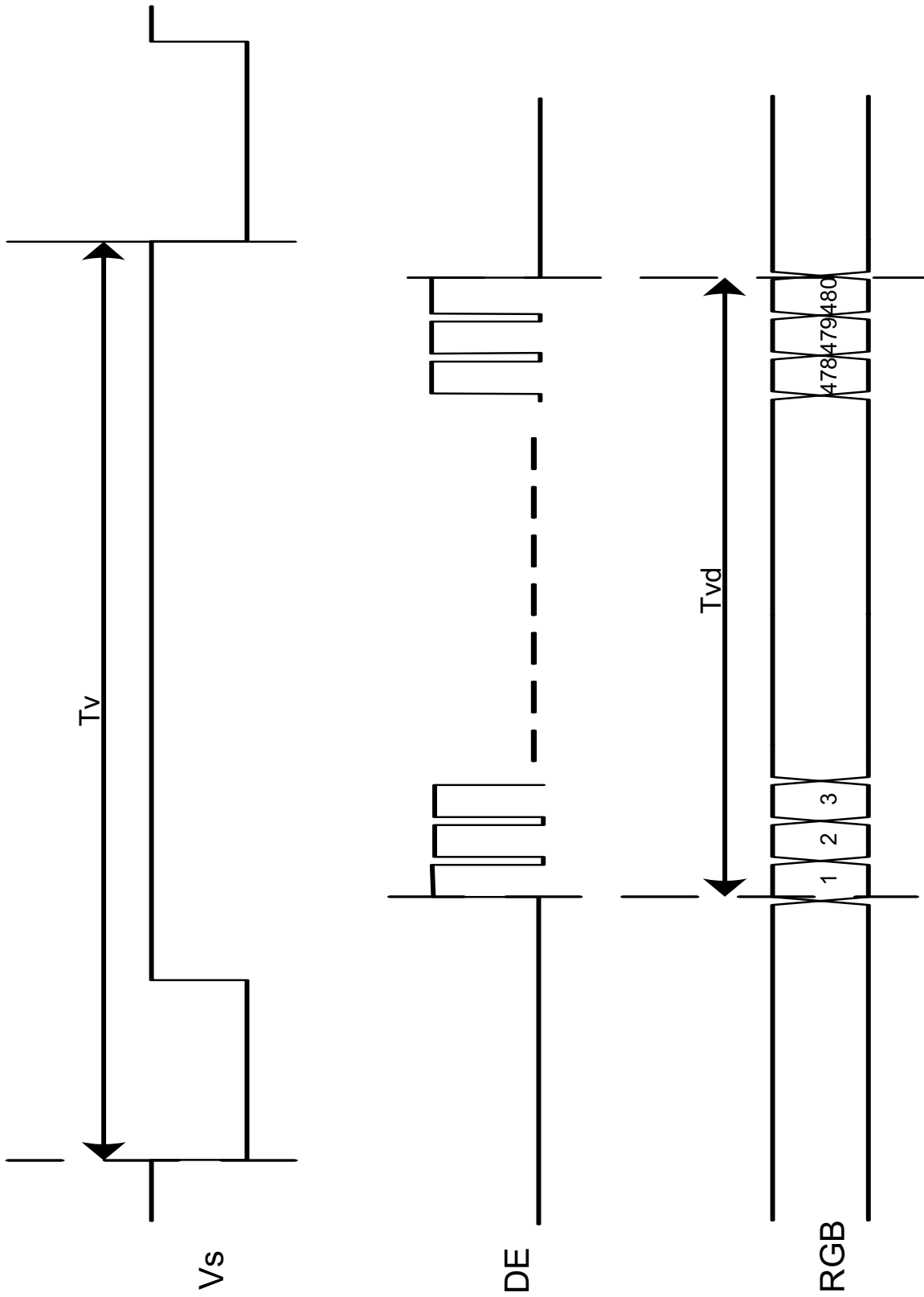
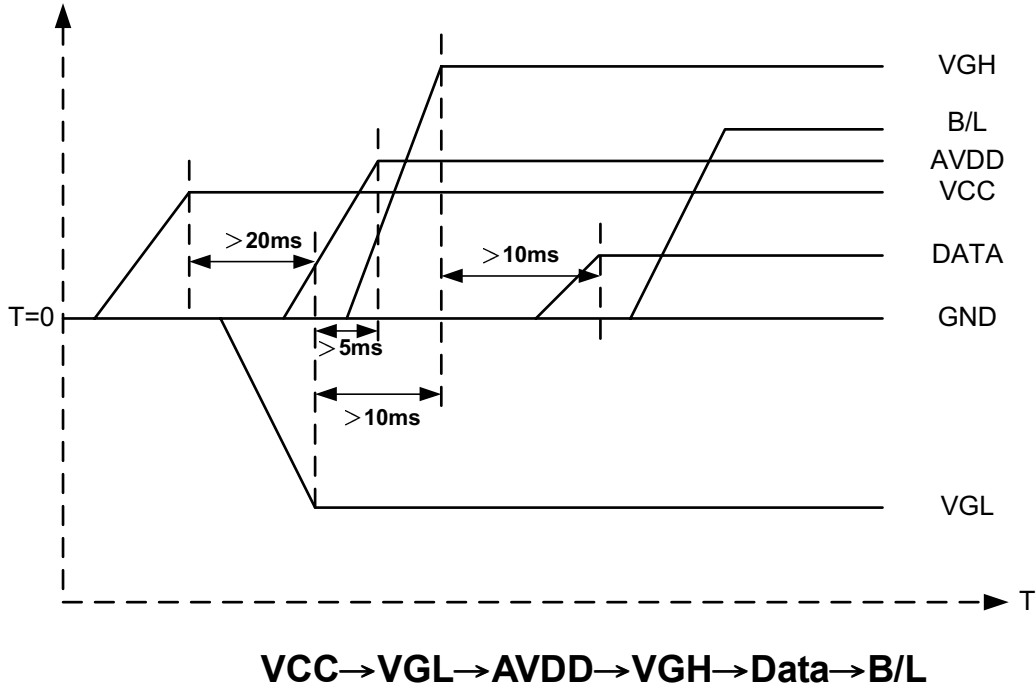

Fig.3-7 Vertical timina

2. Power Sequence

2.1 Power on:



2.2 Power off:

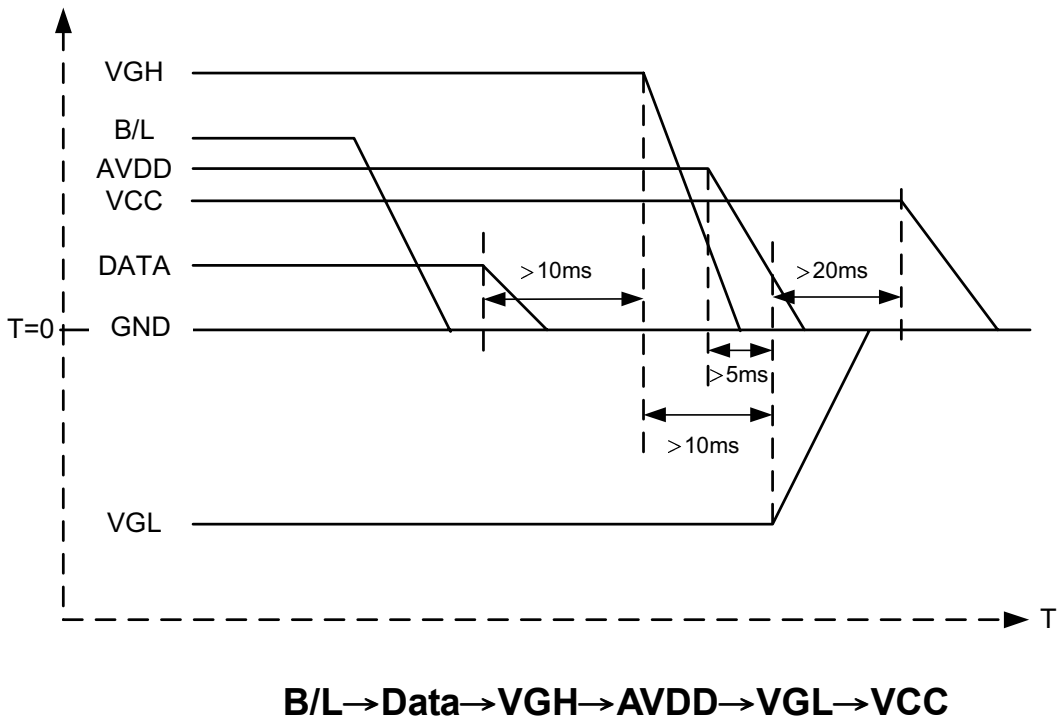

Note: Data includes POL, STVD, OEV, CKV, STVU, EDGSL, STHL, REV, DCLK, , STHR, LD.

■ RELIABILITY TEST

No.	Test Item	Test Condition	Inspection after test
1	High Temperature Storage	$85 \pm 2^{\circ}\text{C}/240$ hours	Note 1,Note 4
2	Low Temperature Storage	$-30 \pm 2^{\circ}\text{C}/240$ hours	Note 1,Note 4
3	High Temperature Operating	$85 \pm 2^{\circ}\text{C}/240$ hours	Note 2,Note 4
4	Low Temperature Operating	$-30 \pm 2^{\circ}\text{C}/240$ hours	Note 1,Note 4
5	Temperature Cycle	$-30 \pm 2^{\circ}\text{C} \sim 25 \sim 85 \pm 2^{\circ}\text{C} \times 100$ cycles	Note 4
6	Damp Proof Test	$60^{\circ}\text{C} \pm 5^{\circ}\text{C} \times 90\%\text{RH}/240$ hours	Note 4
7	Vibration Test	Frequency range: 10Hz~55Hz Stroke: 1.5mm, Sweep: 10Hz~55Hz~10Hz 2hours for each direction of X,Y,Z. (6 hours for total)	
8	Mechanical Shock	100G 6ms, $\pm X, \pm Y, \pm Z$ 3times for each direction	
9	Package Drop Test	Height:60 cm 1 corner, 3 edges, 6 surfaces	
10	Package Vibration Test	Random Vibration: 0.015G*G/Hz from 5-200Hz,-6dB/Octave from 200-500Hz 2 hours for each direction of X.Y.Z. (6 hours for total)	
11	ESD test	$\pm 2\text{KV}$,Human Body Mode, 100pF,/1500 Ω	

Note 1: T_a is the ambient temperature of samples.

Note 2: T_s is the temperature of panel's surface.

Note 3: In the standard condition, there shall be no practical problem that may affect the display function. After the reliability test, the product only guarantees operation, but doesn't guarantee all the cosmetic specification.

Note 4: Before cosmetic and function tests, the product must have enough recovery time, at least 2 hours at room temperature.

■ INSPECTION CRITERION

This specification is made to be used as the standard acceptance/rejection criteria for Normal LCM Product.

1 Sample plan

Sampling plan according to GB/T2828.1-2003/ISO 2859-1: 1999 and ANSI/ASQC Z1.4-1993, normal level 2 and based on:

Major defect: AQL 0.65

Minor defect: AQL 1.5

2. Inspection condition

- Viewing distance for cosmetic inspection is about 30cm with bare eyes, and under an environment of 20~40W light intensity, all directions for inspecting the sample should be within 45° against perpendicular line. (Normal temperature 20~25°C and normal humidity 60±15%RH).

- Driving voltage

The Vop value from which the most optimal contrast can be obtained near the specified Vop in the specification (Within ±0.5V of the typical value at 25°C.).

3. Definition of inspection zone in LCD.

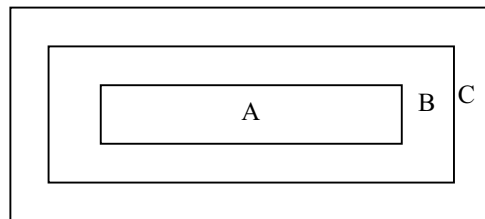

Fig.4

Zone A: character/Digit area

Zone B: viewing area except Zone A (ZoneA+ZoneB=minimum Viewing area)

Zone C: Outside viewing area (invisible area after assembly in customer's product)

Fig.4 Inspection zones in an LCD.

Note: As a general rule, visual defects in Zone C are permissible, when it is no trouble for quality and assembly of customer's product.

4. Inspection Standard

4.1 Major Defect

Item No	Items to be inspected	Inspection Standard	Classification of defects
4.1.1	All functional defects	1) No display 2) Display abnormally 3) Missing vertical, horizontal segment 4) Short circuit 5) Back-light no lighting, flickering and abnormal lighting.	Major
4.1.2	Missing	Missing component	
4.1.3	Outline dimension	Overall outline dimension beyond the drawing is not allowed.	

4.2 Cosmetic Defect

4.2.1 Module Cosmetic Criteria

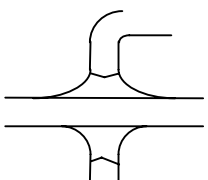
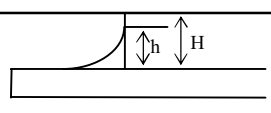
No.	Item	Judgement Criterion	Partition
1	Difference in Spec.	None allowed	Major
2	Pattern peeling	No substrate pattern peeling and floating	Major
3	Soldering defects	No soldering missing No soldering bridge No cold soldering	Major Major Minor
4	Resist flaw on Printed Circuit Boards	visible copper foil ($\varnothing 0.5\text{mm}$ or more) on substrate pattern	Minor
5	Accretion of metallic Foreign matter	No accretion of metallic foreign matters (Not exceed $\varnothing 0.2\text{mm}$)	Minor Minor
6	Stain	No stain to spoil cosmetic badly	Minor
7	Plate discoloring	No plate fading, rusting and discoloring	Minor
8	Solder amount	a. Soldering side of PCB Solder to form a 'Filet' all around the lead. Solder should not hide the lead form perfectly. (too much) b. Components side (In case of 'Through Hole PCB') Solder to reach the Components side of PCB.	Minor
	1. Lead parts		
	2. Flat packages	Either 'Toe' (A) or 'Seal' (B) of the lead to be covered by 'Filet'. Lead form to be assume over solder.	Minor
	3. Chips	$(3/2) H \geq h \geq (1/2) H$ 	Minor
9	Solder ball/Solder splash	a. The spacing between solder ball and the conductor or solder pad $h \geq 0.13\text{mm}$ The diameter of solder ball $d \leq 0.15\text{mm}$. b. The quantity of solder balls or solder Splashes isn't beyond 5 in 600mm^2 . c. Solder balls/Solder splashes do not violate minimum electrical clearance.	Minor Minor Major

	<p>d. Solder balls/Solder splashes must be entrapped/encapsulated Or attached to the metal surface .</p> <p>NOTE: Entrapped/encapsulated/attached is intended to mean that normal service environment of the product will not cause a solder ball to become dislodged.</p>	Minor
--	--	-------

4.2.2Cosmetic Criteria (Non-Operating)

No.	Defect	Judgment Criterion	Partition										
1	Spots	In accordance with <i>Screen Cosmetic Criteria (Operating) No.1.</i>	Minor										
2	Lines	In accordance with <i>Screen Cosmetic Criteria (Operating) No.2.</i>	Minor										
3	Bubbles in polarizer	<table border="1" style="width: 100%; border-collapse: collapse;"> <thead> <tr> <th style="width: 50%;">Size : d mm</th> <th style="width: 50%;">Acceptable Qty in active area</th> </tr> </thead> <tbody> <tr> <td style="text-align: center;">$d \leq 0.3$</td> <td style="text-align: center;">Disregard</td> </tr> <tr> <td style="text-align: center;">$0.3 < d \leq 1.0$</td> <td style="text-align: center;">3</td> </tr> <tr> <td style="text-align: center;">$1.0 < d \leq 1.5$</td> <td style="text-align: center;">1</td> </tr> <tr> <td style="text-align: center;">$1.5 < d$</td> <td style="text-align: center;">0</td> </tr> </tbody> </table>	Size : d mm	Acceptable Qty in active area	$d \leq 0.3$	Disregard	$0.3 < d \leq 1.0$	3	$1.0 < d \leq 1.5$	1	$1.5 < d$	0	Minor
Size : d mm	Acceptable Qty in active area												
$d \leq 0.3$	Disregard												
$0.3 < d \leq 1.0$	3												
$1.0 < d \leq 1.5$	1												
$1.5 < d$	0												
4	Scratch	In accordance with spots and lines operating cosmetic criteria. When the light reflects on the panel surface, the scratches are not to be remarkable.	Minor										
5	Allowable density	Above defects should be separated more than 30mm each other.	Minor										
6	Coloration	Not to be noticeable coloration in the viewing area of the LCD panels. Back-lit type should be judged with back-lit on state only.	Minor										
7	Contamination	Not to be noticeable.	Minor										

4. 2. 3 Cosmetic Criteria (Operating)

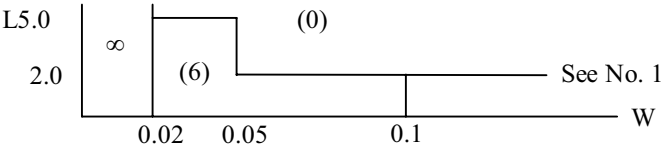
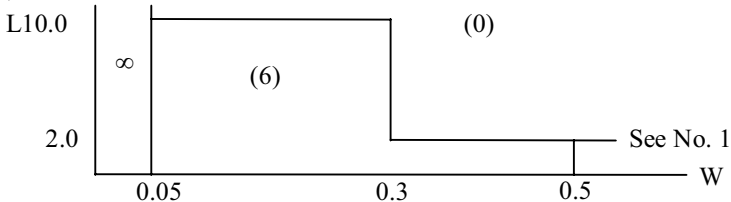
No.	Defect	Judgment Criterion	Partition																																												
1	Spots	<p>A) Clear</p> <table border="1" data-bbox="467 432 1246 748"> <thead> <tr> <th>Lcd size</th> <th>Size : d mm</th> <th>Acceptable Qty in active area</th> </tr> </thead> <tbody> <tr> <td rowspan="4">Lcd size \leq 8.0'</td> <td>$d \leq 0.1$</td> <td>Disregard</td> </tr> <tr> <td>$0.1 < d \leq 0.2$</td> <td>6</td> </tr> <tr> <td>$0.2 < d \leq 0.3$</td> <td>2</td> </tr> <tr> <td>$0.3 < d$</td> <td>0</td> </tr> <tr> <td rowspan="4">Lcd size $>$ 8.0'</td> <td>$d \leq 0.1$</td> <td>Disregard</td> </tr> <tr> <td>$0.1 < d \leq 0.3$</td> <td>10</td> </tr> <tr> <td>$0.3 < d \leq 0.5$</td> <td>5</td> </tr> <tr> <td>$0.5 < d$</td> <td>0</td> </tr> </tbody> </table> <p>Note : Including pin holes and defective dots which must be within one pixel size; Total defective point shall not exceed 6 pcs no more than 8 inch LCD and 10PCS for more than 8 inch LCD.</p> <p>B) Unclear</p> <table border="1" data-bbox="477 943 1257 1301"> <thead> <tr> <th>Lcd size</th> <th>Size : d mm</th> <th>Acceptable Qty in active area</th> </tr> </thead> <tbody> <tr> <td rowspan="4">Lcd size \leq 8.0'</td> <td>$d \leq 0.2$</td> <td>Disregard</td> </tr> <tr> <td>$0.2 < d \leq 0.5$</td> <td>6</td> </tr> <tr> <td>$0.5 < d \leq 0.7$</td> <td>2</td> </tr> <tr> <td>$0.7 < d$</td> <td>0</td> </tr> <tr> <td rowspan="5">Lcd size $>$ 8.0'</td> <td>$d \leq 0.2$</td> <td>Disregard</td> </tr> <tr> <td>$0.2 < d \leq 0.5$</td> <td>10</td> </tr> <tr> <td>$0.5 < d \leq 0.7$</td> <td>3</td> </tr> <tr> <td>$0.7 < d \leq 1.0$</td> <td>1</td> </tr> <tr> <td>$1.0 < d$</td> <td>0</td> </tr> </tbody> </table> <p>Note : Total defective point shall not exceed 6 pcs for no more than 8 inch LCD and 10PCS for more than 8 inch LCD.</p>	Lcd size	Size : d mm	Acceptable Qty in active area	Lcd size \leq 8.0'	$d \leq 0.1$	Disregard	$0.1 < d \leq 0.2$	6	$0.2 < d \leq 0.3$	2	$0.3 < d$	0	Lcd size $>$ 8.0'	$d \leq 0.1$	Disregard	$0.1 < d \leq 0.3$	10	$0.3 < d \leq 0.5$	5	$0.5 < d$	0	Lcd size	Size : d mm	Acceptable Qty in active area	Lcd size \leq 8.0'	$d \leq 0.2$	Disregard	$0.2 < d \leq 0.5$	6	$0.5 < d \leq 0.7$	2	$0.7 < d$	0	Lcd size $>$ 8.0'	$d \leq 0.2$	Disregard	$0.2 < d \leq 0.5$	10	$0.5 < d \leq 0.7$	3	$0.7 < d \leq 1.0$	1	$1.0 < d$	0	Minor
Lcd size	Size : d mm	Acceptable Qty in active area																																													
Lcd size \leq 8.0'	$d \leq 0.1$	Disregard																																													
	$0.1 < d \leq 0.2$	6																																													
	$0.2 < d \leq 0.3$	2																																													
	$0.3 < d$	0																																													
Lcd size $>$ 8.0'	$d \leq 0.1$	Disregard																																													
	$0.1 < d \leq 0.3$	10																																													
	$0.3 < d \leq 0.5$	5																																													
	$0.5 < d$	0																																													
Lcd size	Size : d mm	Acceptable Qty in active area																																													
Lcd size \leq 8.0'	$d \leq 0.2$	Disregard																																													
	$0.2 < d \leq 0.5$	6																																													
	$0.5 < d \leq 0.7$	2																																													
	$0.7 < d$	0																																													
Lcd size $>$ 8.0'	$d \leq 0.2$	Disregard																																													
	$0.2 < d \leq 0.5$	10																																													
	$0.5 < d \leq 0.7$	3																																													
	$0.7 < d \leq 1.0$	1																																													
	$1.0 < d$	0																																													
2	Lines	<p>A) Clear</p>  <p>Note : () - Acceptable Qty in active area L - Length (mm) W - Width (mm) ∞ - Disregard</p> <p>B) Unclear</p>  <p>‘Clear’ = The shade and size are not changed by V_{op}. ‘Unclear’ = The shade and size are changed by V_{op}.</p>	Minor																																												

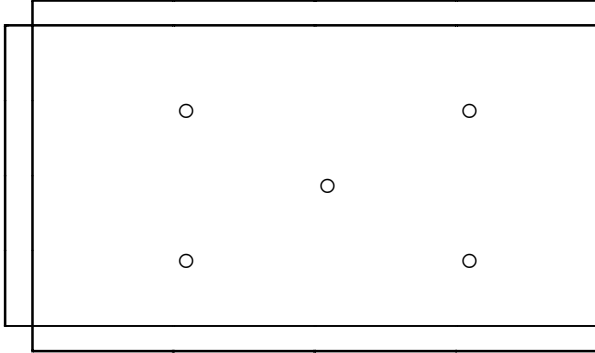
3	Rubbing line	Not to be noticeable.	Minor
4	Allowable density	Above defects should be separated more than 10mm each other.	Minor
5	Rainbow	Not to be noticeable.	Minor
6	Dot size	To be 95% ~ 105% of the dot size (Typ.) in drawing. Partial defects of each dot (ex. pin-hole) should be treated as 'Spot'. (see <i>Screen Cosmetic Criteria (Operating) No.1</i>)	Minor
7	Uneven brightness (only back-lit type module)	<p>Uneven brightness must be $B_{MAX} / B_{MIN} \leq 2$</p> <ul style="list-style-type: none"> - B_{MAX} : Max. value by measure in 5 points - B_{MIN} : Min. value by measure in 5 points <p>Divide active area into 4 vertically and horizontally. Measure 5 points shown in the following figure.</p>  <p>○ : Measuring points</p>	Minor

Note :

- (1) Size : $d = (\text{long length} + \text{short length}) / 2$
- (2) The limit samples for each item have priority.
- (3) Complex defects are defined item by item, but if the numbers of defects are defined in above table, the total number should not exceed 10.
- (4) In case of 'concentration', even the spots or the lines of 'disregarded' size should not allowed. Following three situations should be treated as 'concentration'.
 - 7 or over defects in circle of $\varnothing 5\text{mm}$.
 - 10 or over defects in circle of $\varnothing 10\text{mm}$.
 - 20 or over defects in circle of $\varnothing 20\text{mm}$.

■PRECAUTIONS FOR USING LCD MODULES

Handling Precautions

(1) The display panel is made of glass and polarizer. As glass is fragile. It tends to become or chipped during handling especially on the edges. Please avoid dropping or jarring. Do not subject it to a mechanical shock by dropping it or impact.

(2) If the display panel is damaged and the liquid crystal substance leaks out, be sure not to get any in your mouth. If the substance contacts your skin or clothes, wash it off using soap and water.

(3) Do not apply excessive force to the display surface or the adjoining areas since this may cause the color tone to vary. Do not touch the display with bare hands. This will stain the display area and degraded insulation between terminals (some cosmetics are determined to the polarizer).

(4) The polarizer covering the display surface of the LCD module is soft and easily scratched. Handle this polarizer carefully. Do not touch, push or rub the exposed polarizers with anything harder than an HB pencil lead (glass, tweezers, etc.). Do not put or attach anything on the display area to avoid leaving marks on. Condensation on the surface and contact with terminals due to cold will damage, stain or dirty the polarizer. After products are tested at low temperature they must be warmed up in a container before coming is contacting with room temperature air.

(5) If the display surface becomes contaminated, breathe on the surface and gently wipe it with a soft dry cloth. If it is heavily contaminated, moisten cloth with one of the following solvents

- Isopropyl alcohol
- Ethyl alcohol

Do not scrub hard to avoid damaging the display surface.

(6) Solvents other than those above-mentioned may damage the polarizer. Especially, do not use the following.

- Water
- Ketone
- Aromatic solvents

Wipe off saliva or water drops immediately, contact with water over a long period of time may cause deformation or color fading. Avoid contacting oil and fats.

(7) Exercise care to minimize corrosion of the electrode. Corrosion of the electrodes is accelerated by water droplets, moisture condensation or a current flow in a high-humidity environment.

(8) Install the LCD Module by using the mounting holes. When mounting the LCD module make sure it is free of twisting, warping and distortion. In particular, do not forcibly pull or bend the I/O cable or the backlight cable.

(9) Do not attempt to disassemble or process the LCD module.

(10) NC terminal should be open. Do not connect anything.

(11) If the logic circuit power is off, do not apply the input signals.

(12) Electro-Static Discharge Control, Since this module uses a CMOS LSI, the same careful attention should be paid to electrostatic discharge as for an ordinary CMOS IC. To prevent destruction of the elements by static electricity, be careful to maintain an optimum work environment.

- Before remove LCM from its packing case or incorporating it into a set, be sure the module and your body have the same electric potential. Be sure to ground the body when handling the LCD modules.

- Tools required for assembling, such as soldering irons, must be properly grounded. make certain the AC power source for the soldering iron does not leak. When using an electric screwdriver to attach LCM, the screwdriver should be of ground potential to minimize as much as possible any transmission of electromagnetic waves produced sparks coming from the commutator of the motor.

- To reduce the amount of static electricity generated, do not conduct assembling and other work under dry conditions. To reduce the generation of static electricity be careful that the air in the work is not too dried. A relative humidity of 50%-60% is recommended. As far as possible make the electric potential of your work clothes and that of the work bench the ground potential

- The LCD module is coated with a film to protect the display surface. Exercise care when peeling off this protective film since static electricity may be generated

(13) Since LCM has been assembled and adjusted with a high degree of precision, avoid applying excessive shocks to the module or making any alterations or modifications to it.

- Do not alter, modify or change the shape of the tab on the metal frame.

- Do not make extra holes on the printed circuit board, modify its shape or change the positions of components to be attached.

- Do not damage or modify the pattern writing on the printed circuit board.

- Absolutely do not modify the zebra rubber strip (conductive rubber) or heat seal connector.

- Except for soldering the interface, do not make any alterations or modifications with a soldering iron.

- Do not drop, bend or twist LCM.

Handling precaution for LCM

LCM is easy to be damaged. Please note below and be careful for handling.

Correct handling:

As above picture, please handle with anti-static gloves around LCM edges.

Incorrect handling:

Please don't touch IC directly.

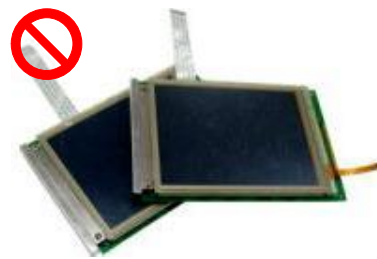

Please don't stack LCM.



Please don't hold the surface of panel.

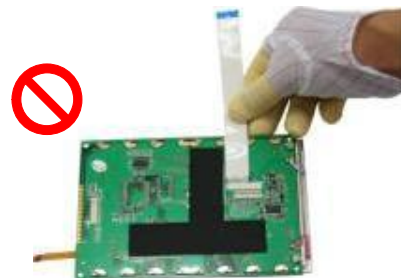

Please don't stretch interface of output, such as FPC cable.



Please don't hold the surface of IC.



Please don't operate with sharp stick such as pens.

Storage Precautions

When storing the LCD modules, the following precaution is necessary.

- (1) Store them in a sealed polyethylene bag. If properly sealed, there is no need for the dessicant.
- (2) Store them in a dark place. Do not expose to sunlight or fluorescent light, keep the temperature between 0°C and 35°C, and keep the relative humidity between 40%RH and 60%RH.
- (3) The polarizer surface should not come in contact with any other objects. (We advise you to store them in the anti-static electricity container in which they were shipped.)

Others

Liquid crystals solidify under low temperature (below the storage temperature range) leading to defective orientation or the generation of air bubbles (black or white). Air bubbles may also be generated if the module is subject to a low temperature.

If the LCD modules have been operating for a long time showing the same display patterns, the display patterns may remain on the screen as ghost images and a slight contrast irregularity may also appear. A normal operating status can be regained by suspending use for some time. It should be noted that this phenomenon does not adversely affect performance reliability.

To minimize the performance degradation of the LCD modules resulting from destruction caused by static electricity etc., exercise care to avoid holding the following sections when handling the modules.

- Exposed area of the printed circuit board.
- Terminal electrode sections.

■ USING LCD MODULES

Installing LCD Modules

The hole in the printed circuit board is used to fix LCM as shown in the picture below. Attend to the following items when installing the LCM.

- (1) Cover the surface with a transparent protective plate to protect the polarizer and LC cell.

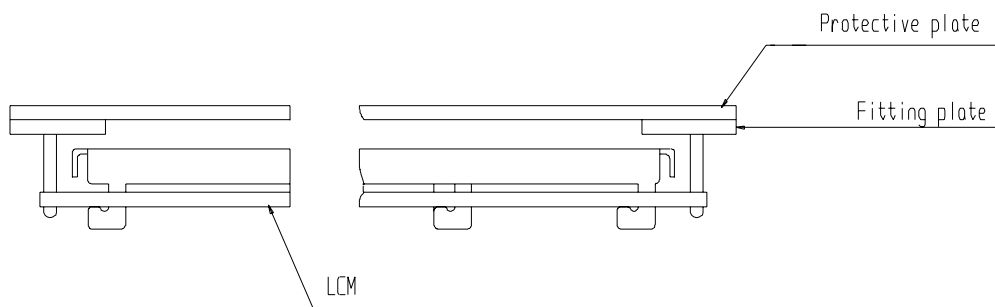

- (2) When assembling the LCM into other equipment, the spacer to the bit between the LCM and the fitting plate should have enough height to avoid causing stress to the module surface, refer to the individual specifications for measurements. The measurement tolerance should be ± 0.1 mm.

Precaution for assemble the module with BTB connector:

Please note the position of the male and female connector position, don't assemble or assemble like the method which the following picture shows

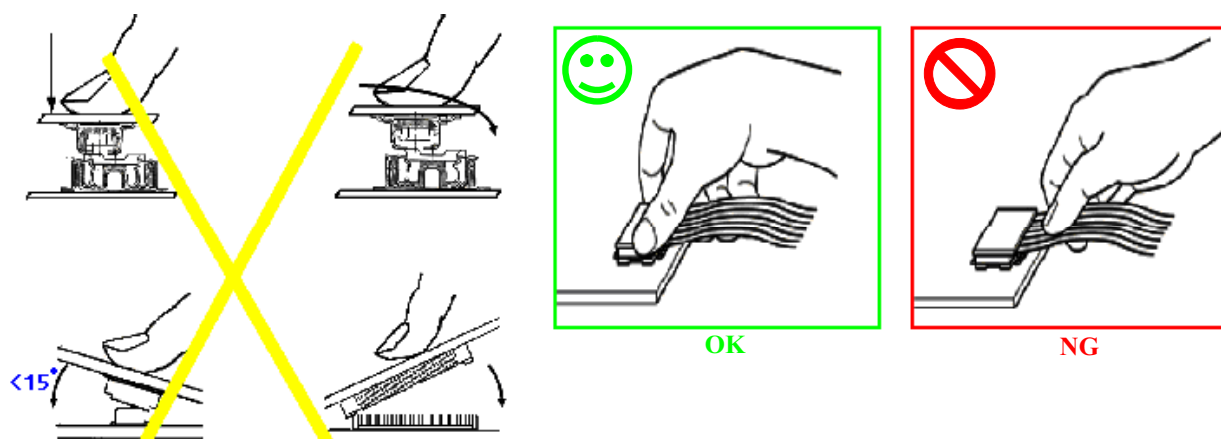

Precaution for soldering the LCM

	Manual soldering	Machine drag soldering	Machine press soldering
No ROHS product	290°C ~350°C. Time : 3-5S.	330°C ~350°C. Speed : 4-8 mm/s.	300°C ~330°C. Time : 3-6S. Press: 0.8~1.2Mpa
ROHS product	340°C ~370°C. Time : 3-5S.	350°C ~370°C. Time : 4-8 mm/s.	330°C ~360°C. Time : 3-6S. Press: 0.8~1.2Mpa

(1) If soldering flux is used, be sure to remove any remaining flux after finishing to soldering operation. (This does not apply in the case of a non-halogen type of flux.) It is recommended that you protect the LCD surface with a cover during soldering to prevent any damage due to flux spatters.

(2) When soldering the electroluminescent panel and PC board, the panel and board should not be detached more than three times. This maximum number is determined by the temperature and time conditions mentioned above, though there may be some variance depending on the temperature of the soldering iron.

(3) When remove the electroluminescent panel from the PC board, be sure the solder has completely melted, the soldered pad on the PC board could be damaged.

Precautions for Operation

(1) Viewing angle varies with the change of liquid crystal driving voltage (VLCD). Adjust VLCD to show the best contrast.

(2) It is an indispensable condition to drive LCD's within the specified voltage limit since the higher voltage then the limit cause the shorter LCD life. An electrochemical reaction due to direct current causes LCD's undesirable deterioration, so that the use of direct current drive should be avoided.

(3) Response time will be extremely delayed at lower temperature than the operating temperature range and on the other hand at higher temperature LCD's show dark color in them. However those phenomena do not mean malfunction or out of order with LCD's, Which will come back in the specified operating temperature.

(4) If the display area is pushed hard during operation, the display will become abnormal. However, it will return to normal if it is turned off and then back on.

(5) A slight dew depositing on terminals is a cause for electro-chemical reaction resulting in terminal open circuit. Usage under the maximum operating temperature, 50%RH or less is required.

(6) Input logic voltage before apply analog high voltage such as LCD driving voltage when power on. Remove analog high voltage before logic voltage when power off the module. Input each signal after the positive/negative voltage becomes stable.

(7) Please keep the temperature within specified range for use and storage. Polarization degradation, bubble generation or polarizer peel-off may occur with high temperature and high humidity.

Safety

(1) It is recommended to crush damaged or unnecessary LCDs into pieces and wash them off with solvents such as acetone and ethanol, which should later be burned.

(2) If any liquid leaks out of a damaged glass cell and comes in contact with the hands, wash off thoroughly with soap and water.

Limited Warranty

Unless agreed between Multi-Inno and customer, Multi-Inno will replace or repair any of its LCD modules which are found to be functionally defective when inspected in accordance with Multi-Inno LCD acceptance standards (copies available upon request) for a period of one year from date of production. Cosmetic/visual defects must be returned to Multi-Inno within 90 days of shipment. Confirmation of such date shall be based on data code on product. The warranty liability of Multi-Inno limited to repair and/or replacement on the terms set forth above. Multi-Inno will not be responsible for any subsequent or consequential events.

Return LCM under warranty

No warranty can be granted if the precautions stated above have been disregarded. The typical examples of violations are :

- Broken LCD glass.
- PCB eyelet is damaged or modified.
- PCB conductors damaged.
- Circuit modified in any way, including addition of components.
- PCB tampered with by grinding, engraving or painting varnish.
- Soldering to or modifying the bezel in any manner.

Module repairs will be invoiced to the customer upon mutual agreement. Modules must be returned with sufficient description of the failures or defects. Any connectors or cable installed by the customer must be removed completely without damaging the PCB eyelet, conductors and terminals.

■ PRIOR CONSULT MATTER

- 1.①For Multi-Inno standard products, we keep the right to change material, process ... for improving the product property without notice on our customer.
- ②For OEM products, if any change needed which may affect the product property, we will consult with our customer in advance.
2. If you have special requirement about reliability condition, please let us know before you start the test on our samples.