



MULTI-INNO TECHNOLOGY CO., LTD.

www.multi-inno.com

LCD MODULE SPECIFICATION

Model : MI0570ET-10

For Customer's Acceptance:

Customer	
Approved	
Comment	

Revision	1.1
Engineering	
Date	2013-03-05
Our Reference	

CONTENTS

- GENERAL INFORMATION
- EXTERNAL DIMENSIONS
- ABSOLUTE MAXIMUM RATINGS
- ELECTRICAL CHARACTERISTICS
- ELECTRO-OPTICAL CHARACTERISTICS
- INTERFACE DESCRIPTION
- BLOCK DIAGRAM
- APPLICATION NOTES
- TOUCH PANEL CHARACTERISTICS
- RELIABILITY TEST
- INSPECTION CRITERION
- PRECAUTIONS FOR USING LCD MODULES
- PRIOR CONSULT MATTER

■ GENERAL INFORMATION

Item	Contents	Unit
LCD type	TFT	/
Size	5.7	Inch
Viewing direction	6:00	O' Clock
Gray scale inversion direction	12:00	O' Clock
LCM (W × H × D)	127.00×98.43 ×9.20	mm ³
Active area (W×H)	115.20×86.40	mm ²
Dot pitch (W×H)	0.06×0.18	mm ²
Number of dots	640 (RGB) × 480	/
Backlight type	21 LEDs	/
Interface type	18 bits RGB	/
Color depth	262K	/
Color configuration	R.G.B stripe	/
Surface treatment	Anti-clear,3H	/
Input voltage	3.3	V
With/Without TSP	With TSP	/
Weight	110	g

Note 1: Viewing direction for best image quality is different from TFT definition, there is a 180 degree shift.

Note 2 : RoHS compliant;

Note 3: LCM weight tolerance: ± 5% .

■ ABSOLUTE MAXIMUM RATINGS

Parameter	Symbol	Min	Max	Unit
Power supply voltage	V _{CC}	-0.3	5.0	V
Logic input voltage	V _I	-0.3	V _{CC} +0.3	V
Operating temperature	T _{OP}	-20	70	°C
Storage temperature	T _{ST}	-30	80	°C
Humidity	RH	-	90%(Max60°C)	RH

■ ELECTRICAL CHARACTERISTICS

DC CHARACTERISTICS

Parameter	Symbol	Min	Typ	Max	Unit
Power supply voltage fpr LCD	V _{CC}	3.0	3.3	3.6	V
Power supply current for LCD	I _{CC}	-	111	140	mA
Power supply voltage fpr LED	V _{LED}	4.5	5.0	5.5	V
Power supply current for LED	I _{LED}	-	333	400	mA
Ripple voltage	V _{RF}	-	-	100	mVp-p
Input voltage ' H ' level	V _{IH}	0.7V _{CC}	-	V _{CC}	V
Input voltage ' L ' level	V _{IL}	0	-	0.3V _{CC}	V
ADJ frequency		19K	20K	21K	Hz
ADJ input voltage	V _{IH}	3.0	-	3.3	V
	V _{IL}	0	-	0.3	V
LED dice life time		-	50,000	-	Hr

Note 1: The “ LED dice life time” is defined as the brightness decrease to 50% original brightness that the ambient temperature is 22°C and LED dice current=20mA.

■ELECTRO-OPTICAL CHARACTERISTICS

Item	Symbol	Condition	Min	Typ	Max	Unit	Remark	Note	
Response time	Tr+Tf	$\theta=0^\circ$ $\varnothing=0^\circ$ $T_a=25^\circ\text{C}$	---	50	---	ms	FIG 1.	4	
Contrast ratio	Cr		200	300	---	---	FIG 2.	1	
Luminance uniformity	δ WHITE		70	80	---	%	FIG 2.	3	
Surface Luminance	Lv		640	720	---	cd/m ²	FIG 2.	2	
Viewing angle range	θ	$\varnothing = 90^\circ$	50	60	---	deg	FIG 3.	6	
		$\varnothing = 270^\circ$	30	40	---	deg	FIG 3.		
		$\varnothing = 0^\circ$	60	70	---	deg	FIG 3.		
		$\varnothing = 180^\circ$	60	70	---	deg	FIG 3.		
CIE (x, y) chromaticity	Red	x	$\theta=0^\circ$ $\varnothing=0^\circ$ $T_a=25^\circ\text{C}$	0.565	0.615	0.665	FIG 2.	5	
		y		0.310	0.360	0.410			
	Green	x		0.295	0.345	0.395			
		y		0.490	0.540	0.590			
	Blue	x		0.098	0.148	0.198			
		y		0.056	0.106	0.156			
	White	x		0.259	0.309	0.359			
		y		0.270	0.320	0.370			
Image sticking	-	tis	2 hours	---	---	2	Sec	-	8

Note 1. Contrast Ratio(CR) is defined mathematically as For more information see FIG 2.

$$\text{Contrast Ratio} = \frac{\text{Average Surface Luminance with all white pixels (P1, P2, P3, P4, P5)}}{\text{Average Surface Luminance with all black pixels (P1, P2, P 3,P4, P5)}}$$

Note 2. Surface luminance is the LCD surface from the surface with all pixels displaying white. For more information see FIG 2.

$$L_v = \text{Average Surface Luminance with all white pixels (P1, P2, P 3, P4, P5)}$$

Note 3. The uniformity in surface luminance , δ WHITE is determined by measuring luminance at each test position 1 through 5, and then dividing the maximum luminance of 5 points luminance by minimum luminance of 5 points luminance. For more information see FIG 2.

$$\delta \text{ WHITE} = \frac{\text{Minimum Surface Luminance with all white pixels (P1, P2, P 3, P4, P5)}}{\text{Maximum Surface Luminance with all white pixels (P1, P2, P 3, P4, P5)}}$$

Note 4. Response time is the time required for the display to transition from White to black(Rise Time, Tr) and from black to white(Decay Time, Tf). For additional information see FIG 1. The test equipment is Autronic-Melchers’s ConoScope. Series.

Note 5. CIE (x, y) chromaticity, The x, y value is determined by measuring luminance at each test position 1 through 5,and then make average value.

Note 6. Viewing angle is the angle at which the contrast ratio is greater than 2. For TFT module the contrast ratio is greater than 10. The angles are determined for the horizontal or x axis and the vertical or y axis with respect to the z axis which is normal to the LCD surface. For more information see FIG 3.

Note 7. For viewing angle and response time testing, the testing data is base on Autronic-Melchers’s ConoScope. Series Instruments For contrast ratio, Surface Luminance, Luminance uniformity, CIE The test data is base on TOPCON’s BM-5 photo detector.

Note 8: Definition of Image sticking (tis):
 Continuously display the test pattern shown in the figure below for 2 hours. Then display a completely white screen. The previous image shall not persist more than 2 sec at 25°C

Image sticking pattern

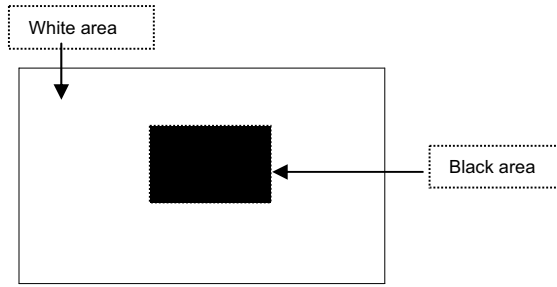

FIG. 1 The definition of Response Time

The response time is defined as the following figure and shall be measured by switching the input signal for "black" and "white".

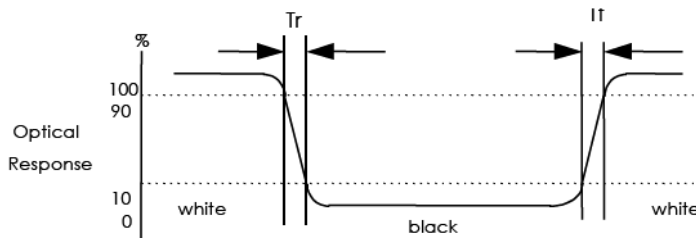

FIG. 2 Measuring method for Contrast ratio, surface luminance, Luminance uniformity, CIE (x, y) chromaticity

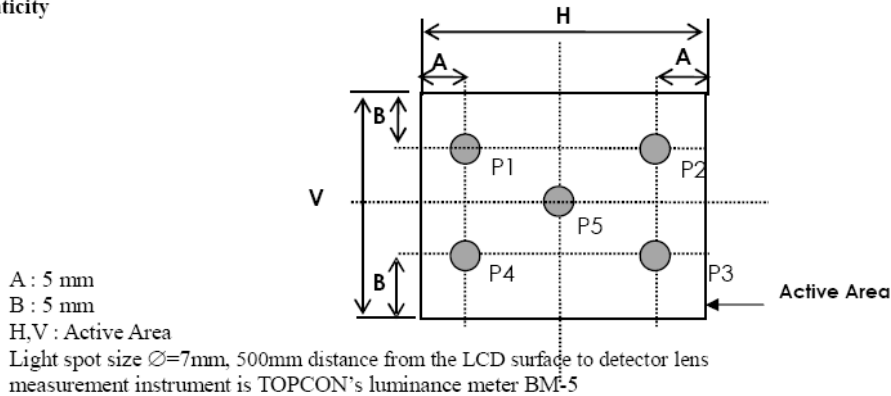
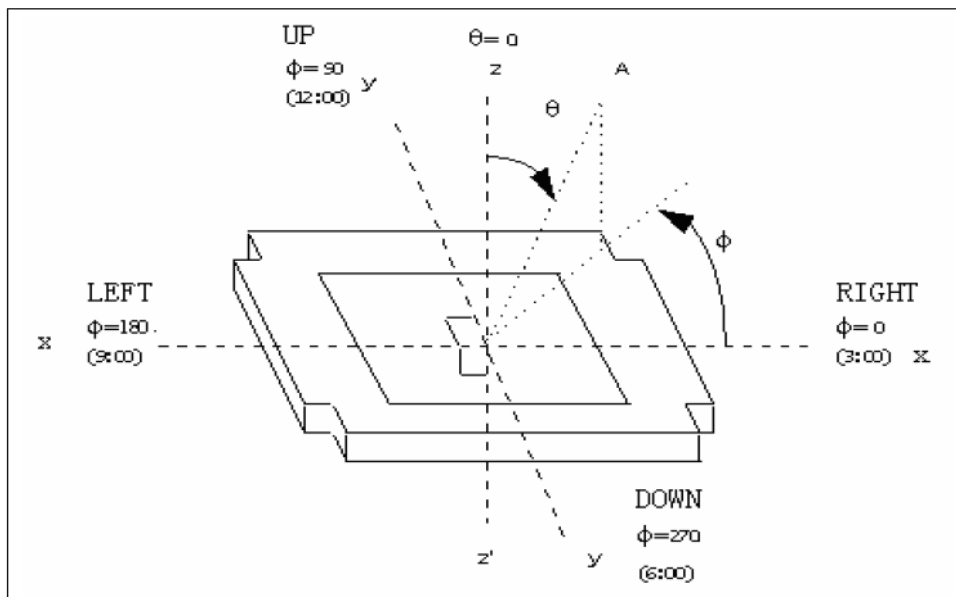

FIG. 3 The definition of viewing angle



■ INTERFACE DESCRIPTION

Pin NO.	SYMBOL	DESCRIPTION
1	U/D	Up or Down Display Control
2	NC	No Connection
3	Hsync	Horizontal SYNC.
4	VLED	Power Supply for LED Driver circuit
5	VLED	Power Supply for LED Driver circuit
6	VLED	Power Supply for LED Driver circuit
7	V _{cc}	Power Supply for LCD
8	Vsync	Vertical SYNC.
9	DE	Data Enable
10	X2	Touch Panel control (Left)
11	Y1	Touch Panel control (Up)
12	ADJ	Brightness control for LED B/L
13	B5	Blue Data 5 (MSB)
14	B4	Blue Data 4
15	B3	Blue Data 3
16	V _{ss}	Power Ground
17	B2	Blue Data 2
18	B1	Blue Data 1
19	B0	Blue Data 0 (LSB)
20	V _{ss}	Power Ground
21	G5	Green Data 5 (MSB)
22	G4	Green Data 4
23	G3	Green Data 3
24	V _{ss}	Power Ground
25	G2	Green Data 2
26	G1	Green Data 1
27	G0	Green Data 0 (LSB)
28	V _{ss}	Power Ground
29	R5	Red Data 5 (MSB)
30	R4	Red Data 4
31	R3	Red Data 3
32	V _{ss}	Power Ground
33	R2	Red Data 2
34	R1	Red Data 1
35	R0	Red Data 0
36	X1	Touch Panel control (Right)
37	Y2	Touch Panel control (Down)
38	DCLK	Clock Signals ; Latch Data at the Falling Edge
39	V _{ss}	Power Ground
40	L/R	Left or Right Display Control

Remarks :

- 1) ADJ is brightness control Pin. The larger of the pulse duty is, the higher of the brightness.
- 2) ADJ signal is 0~3.3V.Operation frequency is 20KHz
- 3) VSS PIN must be grounding, can not be floating.

4) U/D and L/R control Function

L/R	U/D	Function
1	0	Normally display
0	0	Left and Right opposite
1	1	Up and Down opposite
0	1	Left and Right opposite · Up and Down opposite

5) If DE signal is fixed low, SYNC mode is used. Otherwise, DE mode is used.

1.1 Power Signal Sequence

Remarks:

*1) Power Signal sequence:

$t1 \leq 10ms$: $1 \text{ sec} \leq t5$

$50ms \leq t2$: $200ms \leq t6$

$0 < t3 \leq 50ms$: $200ms \leq t7$

$0 < t4 \leq 10ms$

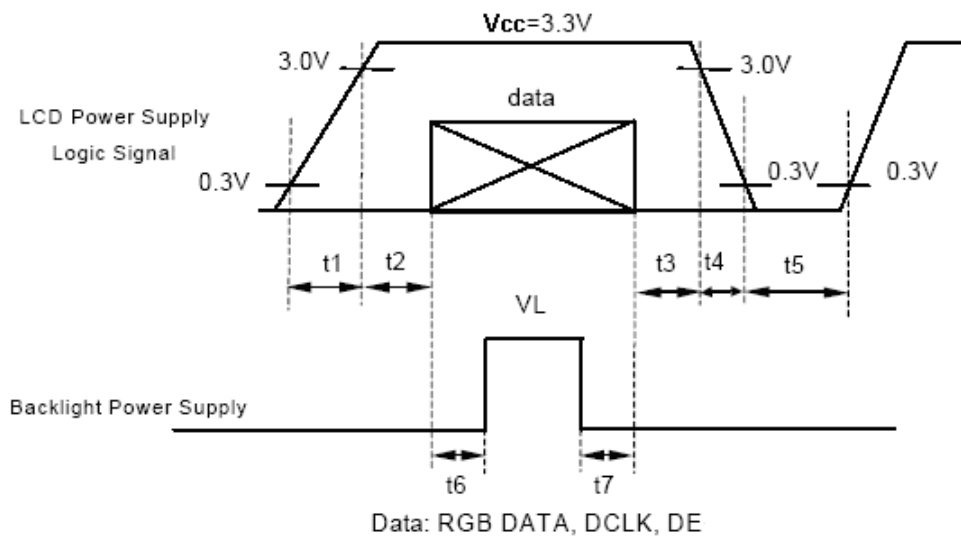

*2) VCC-dip condition:

(1) $2.7V \leq VCC < 3.0V, t_d \leq 10 \text{ ms}$

(2) $VCC > 3.0V$, VCC-dip condition should be the same with VCC-turn-on condition.

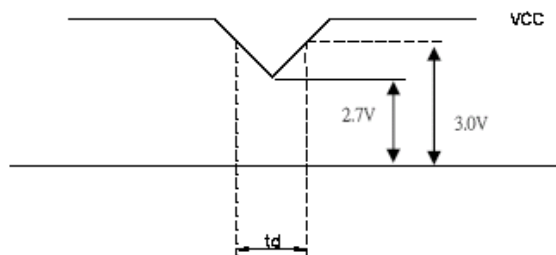

■ BLOCK DIAGRAM

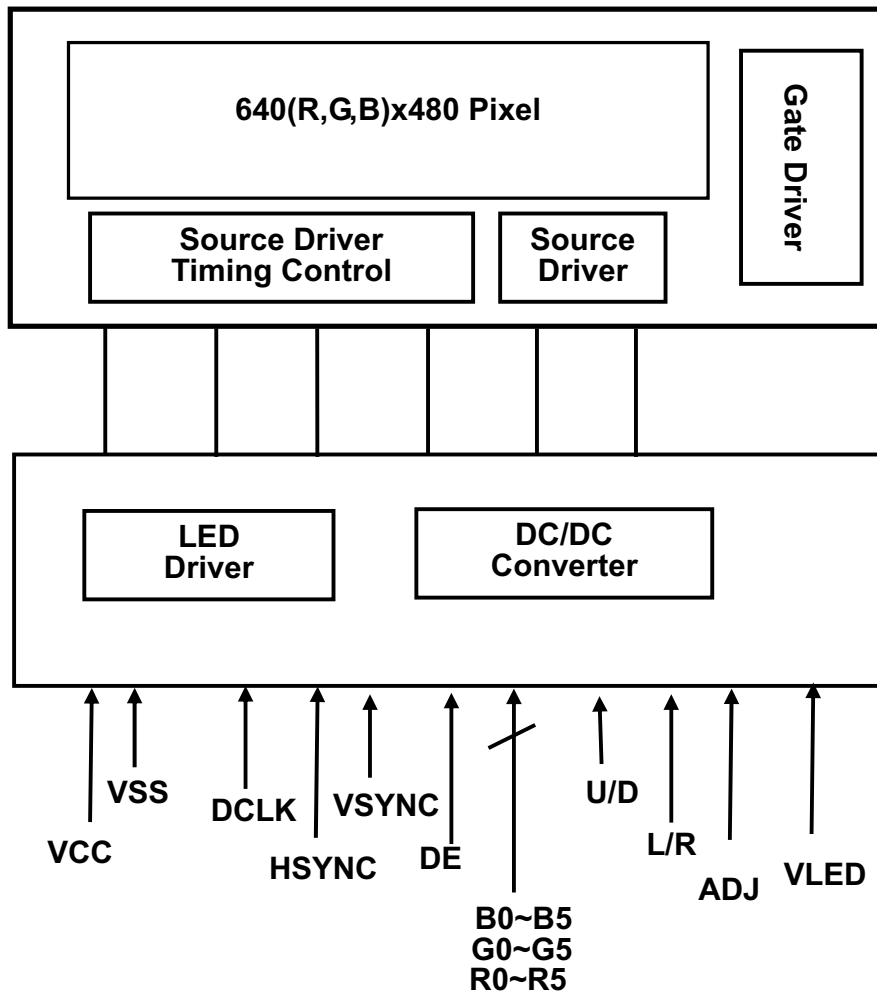

APPLICATION NOTES

1. INTERFACE SPECIFICATIONS

1.1 DE mode Input signal characteristics

Signal	Parameter	Symbol	MIN.	TYP.	MAX.	Unit	Remarks
DCLK	Period	t_{CLK}	33	40	43	ns	
	Frequency	f_{CLK}	23	25	30	MHz	
	Low Level Width	t_{WCL}	6	-	-	ns	
	High Level Width	t_{WCH}	6	-	-	ns	
	Rise, Fall Time	t_{CLKr}, t_{CLKf}	-	-	3	ns	
	Duty	-	0.45	0.50	0.55	-	
DE (Data Enable)	Setup Time	t_{DES}	5	-	-	ns	
	Hold Time	t_{DEH}	10	-	-	ns	
	Rise, Fall Time	t_{DEr}, t_{DEf}	-	-	16	ns	
	Horizontal Period	t_{HP}	750	800	900	t_{CLK}	
	Horizontal Valid	t_{HV}	640	640	640	t_{CLK}	
	Horizontal Blank	t_{HBK}	110	160	260	t_{CLK}	
	Vertical Period	t_{VP}	515	525	560	t_{HP}	
	Vertical Valid	t_W	480	480	480	t_{HP}	
	Vertical Blank	t_{VBK}	35	45	80	t_{HP}	
	Vertical Frequency	f_v	55	60	65	Hz	
Data R,G,B	Setup Time	t_{DS}	5	-	-	ns	
	Hold Time	t_{DH}	10	-	-	ns	
	Rise, Fall Time	t_{Dr}, t_{Df}	-	-	3	ns	

Note: (1) t_{CLKL} / t_{CLK} .

1.1.1 DE mode timing waveform

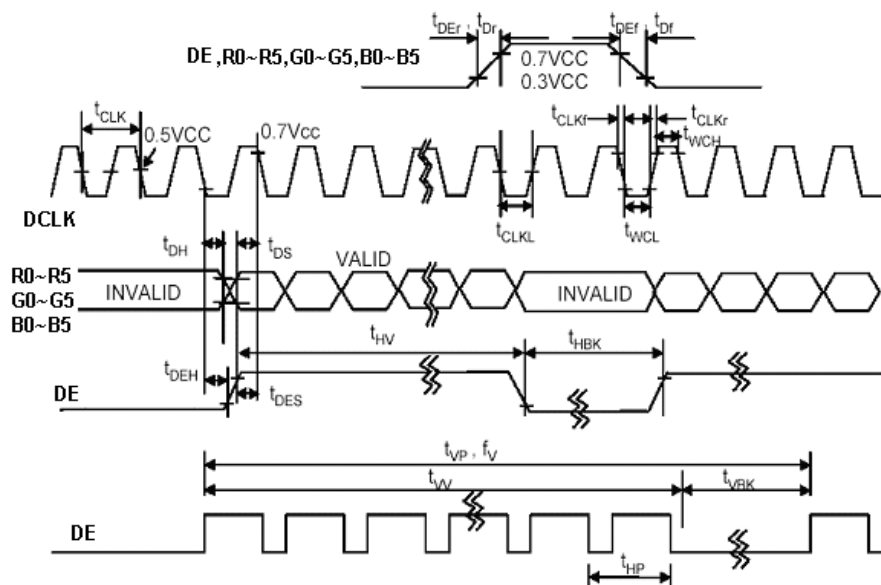

1.2 SYNC mode Input signal characteristics

Parameter	Symbol	MIN.	TYP.	MAX.	Unit	Remarks
Clock Period	t_{CLK}	33	40	43	ns	
Clock Frequency	f_{CLK}	23	25	30	MHz	
Clock Low Level Width	t_{WCL}	6	-	-	ns	
Clock High Level Width	t_{WCH}	6	-	-	ns	
Clock Rise, Fall Time	t_{CLKr}, t_{CLKf}	-	-	3	ns	
HSYNC Period	t_{HP}	750	800	900	t_{CLK}	
HSYNC Pulse Width	t_{HW}	5	30	-	t_{CLK}	
HSYNC Front Porch	t_{HFP}	1	16	116	t_{CLK}	
HSYNC Back Porch	t_{HBP}	1	114	139	t_{CLK}	
HSYNC Width + Back Porch	$t_{HW} + t_{HBP}$	144	144	144	t_{CLK}	
Horizontal Blank	t_{HBK}	1	160	260	t_{CLK}	
Horizontal Valid	t_{HV}	640	640	640	t_{CLK}	
VSYNC Period	t_{VP}	515	525	560	t_{HP}	
VSYNC Pulse Width	t_{VW}	1	3	5	t_{HP}	
VSYNC Front Porch	t_{VFP}	1	10	45	t_{HP}	
VSYNC Back Porch	t_{VBP}	30	32	34	t_{HP}	
VSYNC Width + Back Porch	$t_{VW} + t_{VBP}$	35	35	35	t_{CLK}	
Vertical Blank	t_{VBK}	35	45	80	t_{HP}	
Valid data Width	t_W	480	480	480	t_{HP}	
Data Setup Time	t_{DS}	5	-	-	ns	
Data Hold Time	t_{DH}	10	-	-	ns	

Note: (1) $t_{HBK} = t_{HFP} + t_{HW} + t_{HBP}$

1.2.1 SYNC mode timing waveform

1.2.1.1 Input vertical timing

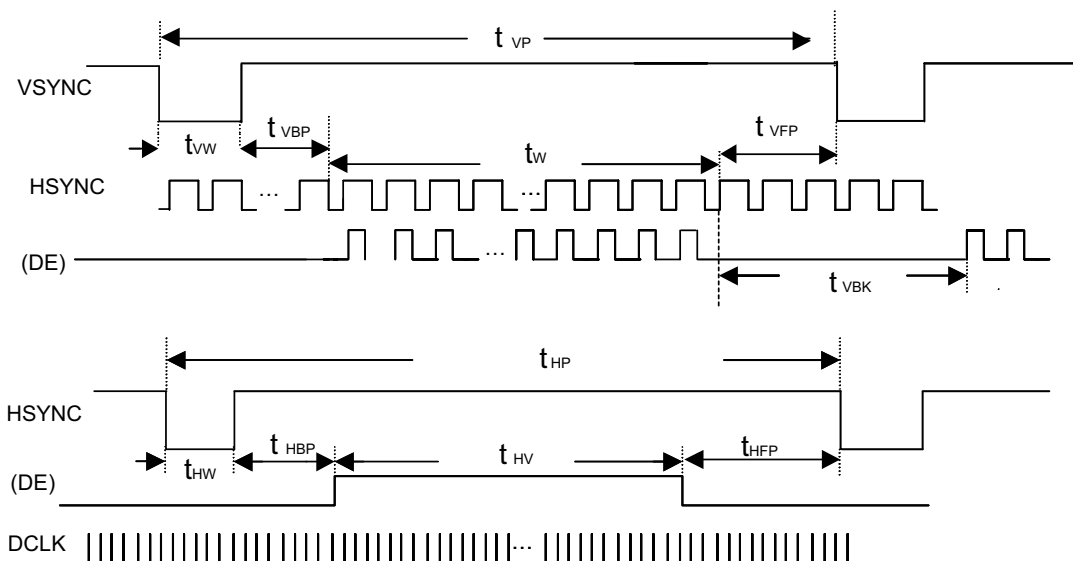

Remark : If SYNC mode is used, please fix DE signal to low, DE timing waveform is for reference only.

1.2.1.2 Input horizontal timing

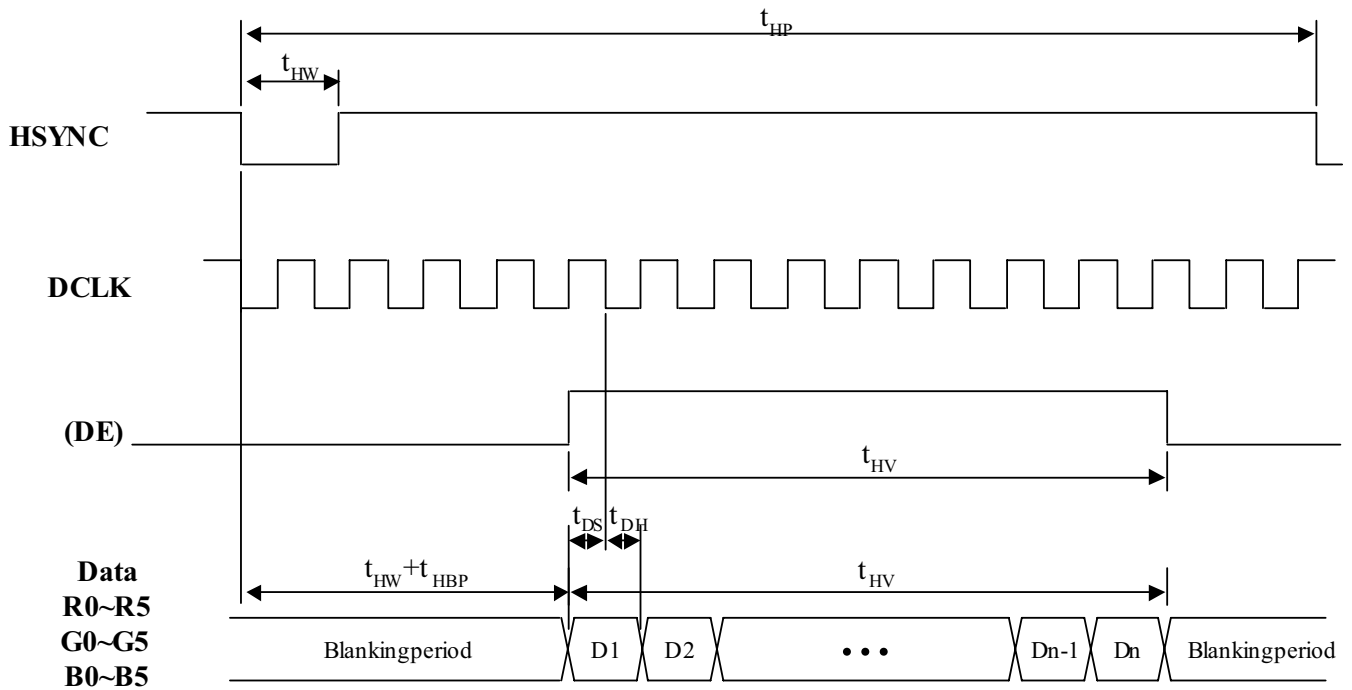

Remark : If SYNC mode is used, please fix DE signal to low, DE timing waveform is for reference only.



1.3 Color Data Assignment

COLOR	INPUT	R DATA						G DATA						B DATA						
		DATA	R5	R4	R3	R2	R1	R0	G5	G4	G3	G2	G1	G0	B5	B4	B3	B2	B1	B0
			MSB					LSB	MSB					LSB	MSB					LSB
BASIC COLOR	BLACK	0	0	0	0	0	0	0	0	0	0	0	0	0	0	0	0	0	0	0
	RED(63)	1	1	1	1	1	1	0	0	0	0	0	0	0	0	0	0	0	0	0
	GREEN(63)	0	0	0	0	0	0	1	1	1	1	1	1	0	0	0	0	0	0	0
	BLUE(63)	0	0	0	0	0	0	0	0	0	0	0	0	1	1	1	1	1	1	1
	CYAN	0	0	0	0	0	0	1	1	1	1	1	1	1	1	1	1	1	1	1
	MAGENTA	1	1	1	1	1	1	0	0	0	0	0	0	1	1	1	1	1	1	1
	YELLOW	1	1	1	1	1	1	1	1	1	1	1	1	0	0	0	0	0	0	0
	WHITE	1	1	1	1	1	1	1	1	1	1	1	1	1	1	1	1	1	1	1
RED	RED(0)	0	0	0	0	0	0	0	0	0	0	0	0	0	0	0	0	0	0	0
	RED(1)	0	0	0	0	0	1	0	0	0	0	0	0	0	0	0	0	0	0	0
	RED(2)	0	0	0	0	1	0	0	0	0	0	0	0	0	0	0	0	0	0	0
	:	:	:	:	:	:	:	:	:	:	:	:	:	:	:	:	:	:	:	:
	:	:	:	:	:	:	:	:	:	:	:	:	:	:	:	:	:	:	:	:
	RED(62)	1	1	1	1	1	0	0	0	0	0	0	0	0	0	0	0	0	0	0
	RED(63)	1	1	1	1	1	1	0	0	0	0	0	0	0	0	0	0	0	0	0
GREEN	GREEN(0)	0	0	0	0	0	0	0	0	0	0	0	0	0	0	0	0	0	0	0
	GREEN(1)	0	0	0	0	0	0	0	0	0	0	0	1	0	0	0	0	0	0	0
	GREEN(2)	0	0	0	0	0	0	0	0	0	0	1	0	0	0	0	0	0	0	0
	:	:	:	:	:	:	:	:	:	:	:	:	:	:	:	:	:	:	:	:
	:	:	:	:	:	:	:	:	:	:	:	:	:	:	:	:	:	:	:	:
	GREEN(62)	0	0	0	0	0	0	1	1	1	1	1	0	0	0	0	0	0	0	0
	GREEN(63)	0	0	0	0	0	0	1	1	1	1	1	1	0	0	0	0	0	0	0
BLUE	BLUE(0)	0	0	0	0	0	0	0	0	0	0	0	0	0	0	0	0	0	0	0
	BLUE(1)	0	0	0	0	0	0	0	0	0	0	0	0	0	0	0	0	0	0	1
	BLUE(2)	0	0	0	0	0	0	0	0	0	0	0	0	0	0	0	0	0	1	0
	:	:	:	:	:	:	:	:	:	:	:	:	:	:	:	:	:	:	:	:
	:	:	:	:	:	:	:	:	:	:	:	:	:	:	:	:	:	:	:	:
	BLUE(62)	0	0	0	0	0	0	0	0	0	0	0	0	1	1	1	1	1	1	0
	BLUE(63)	0	0	0	0	0	0	0	0	0	0	0	0	1	1	1	1	1	1	1

Remarks:(1) Definition of Gray Scale
 color(n):n is series of Gray Scale
 The more n value is, the bright Gray Scale.
 (2)Data:1-High,0-Low

Correspondence between Data and Display Position

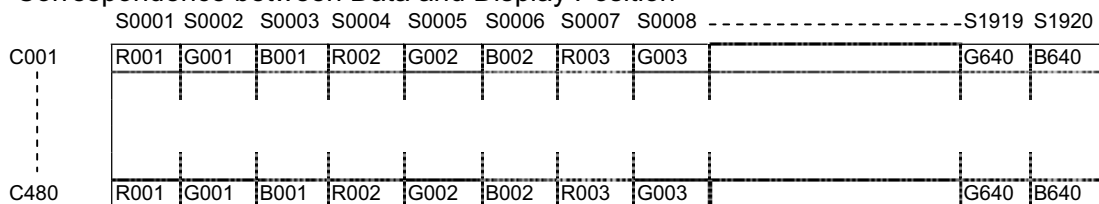

■ TOUCH PANEL CHARACTERISTICS

1. Input Method and Activation Force

Input Method	Activation Force
0.8mm dia. Delrin Polyacetal stylus	50gf Max
8.0mm dia. Silicon "finger"	50gf Max

2. Typical Optical Characteristics

ITEM	Parameter
Visible Light Transmission	81%(Typ)
Haze	5%(Typ)
Surface Hardness	3H

3. Electrical Specification

ITEM	Parameter
Operating Voltage	7V DC
Circuit close resistance	X 300~1000Ω
	Y 100~800Ω
Circuit open resistance	>10MΩ at 25V DC
Contact bounce	20ms
Linear Test	<1.5%

4. Linearity

ITEM	Parameter
Linear Test Specification Direction	X ±1.5%
	Y ±1.5%

5. Specification

ITEM	Parameter
Operating Temperature	-20°C~+70°C
Storage Temperature	-30°C~+80°C

6. Durability test:

6.1 Touch panel is hit 1 millions times with a silicone rubber of R8 finger, hitting rate is by 250g at 2 times per second. The measurement must satisfy the following:

- Circuit close resistance: x 300~1000Ω ;
y 100~800Ω
- Circuit open resistance: >10MΩ at 25V DC
- Contact bounce: 20ms
- Linearity test: ±3.0%

6.2 Stylus writing

Touch panel is drawn by R0.8 Darling stylus pen, at 200g forces, repeat one inch by 100k times. The measurement must satisfy the following:

- Circuit close resistance: x 300~1000Ω ;
y 100~800Ω
- Circuit open resistance: >10MΩ at 25V DC
- Contact bounce: 20ms
- Linearity test: ±3.0%

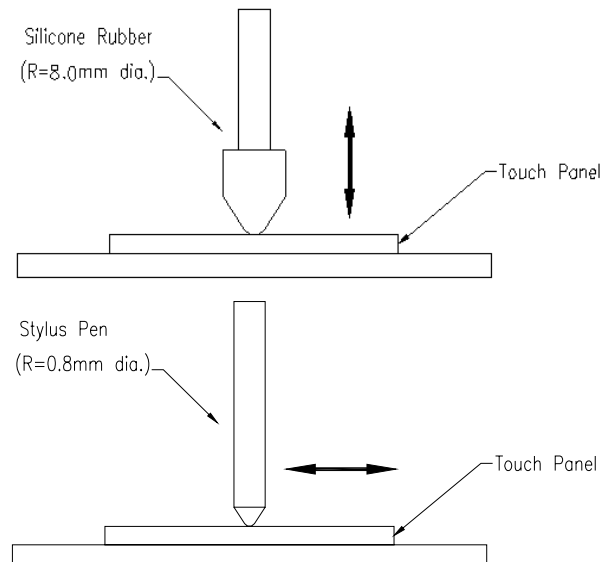

■ RELIABILITY TEST

No.	Test Item	Test Condition
1	High Temperature Storage	$80 \pm 2^{\circ}\text{C}/240$ hours
2	Low Temperature Storage	$-30 \pm 2^{\circ}\text{C}/240$ hours
3	High Temperature Operating	$70 \pm 2^{\circ}\text{C}/240$ hours
4	Low Temperature Operating	$-20 \pm 2^{\circ}\text{C}/240$ hours
5	Temperature Cycle storage	$-30 \pm 2^{\circ}\text{C} \sim 25 \sim 80 \pm 2^{\circ}\text{C} \times 200$ cycles (30min.) (5min.) (30min.)
6	Damp proof Test operating	$60^{\circ}\text{C} \pm 5^{\circ}\text{C} \times 90\% \text{RH}/240$ hours
7	Vibration Test (no-operation)	Frequency: 0~55Hz Amplitude: 1.5mm Sweep time: 11min 6 cycles for each direction of X.Y.Z
8	ESD test (No operation)	150pF, 330Ω Air: $\pm 12\text{KV}$; Contact: $\pm 6\text{KV}$ 10 time/point; 4 point/panel face

■ INSPECTION CRITERION

	OUTGOING QUALITY STANDARD	PAGE 1 OF 8
TITLE:FUNCTIONAL TEST & INSPECTION CRITERIA		

This specification is made to be used as the standard acceptance/rejection criteria for Wider Screen TFT-LCD module product.

1. Sample plan

Sampling plan according to GB/T2828.1-2003/ISO 2859-1 : 1999 and ANSI/ASQC Z1.4-1993, normal level 2 and based on:

Major defect: AQL 0.65

Minor defect: AQL 1.5

2. Inspection condition

Viewing distance for cosmetic inspection is about 30cm with bare eyes, and under an environment of 20~40W light intensity, all directions for inspecting the sample should be within 45° against perpendicular line.

3. Definition of Inspection Item.

3.1 Definition of inspection zone in LCD.

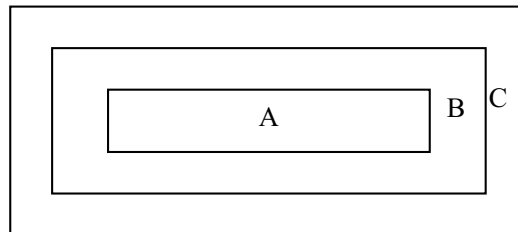

Zone A: character/Digit area

Zone B: viewing area except Zone A (ZoneA+ZoneB=minimum Viewing area)

Zone C: Outside viewing area (invisible area after assembly in customer's product)

ZoneB+ZoneC= Around opaque edge area on TP.

Fig.1 Inspection zones in an LCD.

Note: As a general rule, visual defects in Zone C are permissible, when it is no trouble for quality and assembly of customer's product.

3.2 Definition of some visual defect

Bright dot.	Dots appear bright and unchanged in size in which LCD panel is displaying under black pattern.
Dark dot.	Dots appear dark and unchanged in size in which LCD panel is displaying under pure red, green, blue picture, or pure whiter picture.
Dark / Bright Lines.	Lines on display which appear dark/bright and usually result from the contamination.

 OUTGOING QUALITY STANDARD	PAGE 2 OF 8
--	-------------

TITLE:FUNCTIONAL TEST & INSPECTION CRITERIA

4. Major Defect

Item No	Items to be inspected	Inspection Standard	Classification of defects
4.1	All functional defects	1) No display 2) Display abnormally 3) Open or missing segment 4) Short circuit 5) Excess power consumption 6) Back-light no lighting, flickering and abnormal lighting.	Major
4.2	Missing	Missing component	
4.3	Outline dimension	Overall outline dimension beyond the drawing is not allowed.	
4.4	Crack	Creaks tend to break are not allowed.	

5. Minor Defect

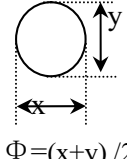
Item No	Items to be inspected	Inspection Standard	Classification of defects																	
5.1	Bright dot defect.  $\Phi = (x+y) / 2$	<table border="1" style="width:100%; border-collapse: collapse;"> <thead> <tr> <th rowspan="2" style="width: 30%;">Zone Size(mm)</th> <th colspan="3">Acceptable Qty</th> </tr> <tr> <th style="width: 15%;">A</th> <th style="width: 15%;">B</th> <th style="width: 15%;">C</th> </tr> </thead> <tbody> <tr> <td>$\Phi \leq 0.15$</td> <td colspan="2">Acceptable (clustering of spot not allowed)</td> <td rowspan="3" style="text-align: center;">Acceptable</td> </tr> <tr> <td>$0.15 < \Phi \leq 0.25$</td> <td colspan="2">N ≤ 6.</td> </tr> <tr> <td>$0.25 < \Phi \leq 0.50$</td> <td colspan="2">N ≤ 2</td> </tr> </tbody> </table>	Zone Size(mm)	Acceptable Qty			A	B	C	$\Phi \leq 0.15$	Acceptable (clustering of spot not allowed)		Acceptable	$0.15 < \Phi \leq 0.25$	N ≤ 6.		$0.25 < \Phi \leq 0.50$	N ≤ 2		Minor
Zone Size(mm)	Acceptable Qty																			
	A	B	C																	
$\Phi \leq 0.15$	Acceptable (clustering of spot not allowed)		Acceptable																	
$0.15 < \Phi \leq 0.25$	N ≤ 6.																			
$0.25 < \Phi \leq 0.50$	N ≤ 2																			
5.2	Dark dot defect.	<table border="1" style="width:100%; border-collapse: collapse;"> <thead> <tr> <th rowspan="2" style="width: 30%;">Zone Size(mm)</th> <th colspan="3">Acceptable Q'ty</th> </tr> <tr> <th style="width: 15%;">A</th> <th style="width: 15%;">B</th> <th style="width: 15%;">C</th> </tr> </thead> <tbody> <tr> <td>$\Phi \leq 0.15$</td> <td colspan="2">Acceptable</td> <td rowspan="3" style="text-align: center;">Acceptable</td> </tr> <tr> <td>$0.15 < \Phi \leq 0.30$</td> <td colspan="2">N ≤ 6</td> </tr> <tr> <td>$0.30 < \Phi \leq 0.50$</td> <td colspan="2">N ≤ 4</td> </tr> </tbody> </table>	Zone Size(mm)	Acceptable Q'ty			A	B	C	$\Phi \leq 0.15$	Acceptable		Acceptable	$0.15 < \Phi \leq 0.30$	N ≤ 6		$0.30 < \Phi \leq 0.50$	N ≤ 4		
Zone Size(mm)	Acceptable Q'ty																			
	A	B	C																	
$\Phi \leq 0.15$	Acceptable		Acceptable																	
$0.15 < \Phi \leq 0.30$	N ≤ 6																			
$0.30 < \Phi \leq 0.50$	N ≤ 4																			
5.3	Bright / Dark line.	$0.01 < W \leq 0.10, \quad 0.30 < L \leq 1.50, \quad N \leq 1$	Acceptable																	

Note: 1. Total defective dots shall not exceed 6 pcs.
 2. Minimum distance between defective dots is more than 5mm.
 3. 2 Adjacent dark sub pixel defect or bright sub pixel defect is not more than 1pair.
 4. W: Width, L: Length, N: Count.

OUTGOING QUALITY STANDARD	PAGE 3 OF 8
TITLE:FUNCTIONAL TEST & INSPECTION CRITERIA	

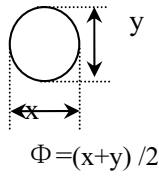
Item No	Items to be inspected	Inspection Standard	Classification of defects																										
5.4	Linear defect Foreign material under polarizer,	<table border="1" style="width:100%; border-collapse: collapse; text-align: center;"> <tr> <th colspan="2">Size(m)</th> <th colspan="3">Acceptable Qty</th> </tr> <tr> <th rowspan="2">L(Length)</th> <th rowspan="2">W(Width)</th> <th colspan="3">Zone</th> </tr> <tr> <th>A</th> <th>B</th> <th>C</th> </tr> <tr> <td>Ignore</td> <td>$W \leq 0.05$</td> <td colspan="2">Acceptable</td> <td rowspan="3" style="writing-mode: vertical-rl; text-orientation: mixed;">Acceptable</td> </tr> <tr> <td>$L \leq 5.0$</td> <td>$0.05 < W \leq 0.15$</td> <td colspan="2">$N \leq 5$</td> </tr> <tr> <td>$5.0 \leq L$</td> <td>$0.15 \leq W$</td> <td colspan="2">0</td> </tr> </table>	Size(m)		Acceptable Qty			L(Length)	W(Width)	Zone			A	B	C	Ignore	$W \leq 0.05$	Acceptable		Acceptable	$L \leq 5.0$	$0.05 < W \leq 0.15$	$N \leq 5$		$5.0 \leq L$	$0.15 \leq W$	0		Minor
	Size(m)		Acceptable Qty																										
L(Length)	W(Width)	Zone																											
		A	B	C																									
Ignore	$W \leq 0.05$	Acceptable		Acceptable																									
$L \leq 5.0$	$0.05 < W \leq 0.15$	$N \leq 5$																											
$5.0 \leq L$	$0.15 \leq W$	0																											
5.4	Circular Defect, Foreign material under polarizer,	 <table border="1" style="width:100%; border-collapse: collapse; text-align: center;"> <tr> <th rowspan="2">Zone Size(mm)</th> <th colspan="3">Acceptable Q'ty</th> </tr> <tr> <th>A</th> <th>B</th> <th>C</th> </tr> <tr> <td>$\Phi \leq 0.25$</td> <td colspan="2">Acceptable</td> <td rowspan="3" style="writing-mode: vertical-rl; text-orientation: mixed;">Acceptable</td> </tr> <tr> <td>$0.25 < \Phi \leq 0.50$</td> <td colspan="2">$N \leq 4$</td> </tr> <tr> <td>$0.50 \leq \Phi$</td> <td colspan="2">0</td> </tr> </table>	Zone Size(mm)	Acceptable Q'ty			A	B	C	$\Phi \leq 0.25$	Acceptable		Acceptable	$0.25 < \Phi \leq 0.50$	$N \leq 4$		$0.50 \leq \Phi$	0		Minor									
	Zone Size(mm)	Acceptable Q'ty																											
A		B	C																										
$\Phi \leq 0.25$	Acceptable		Acceptable																										
$0.25 < \Phi \leq 0.50$	$N \leq 4$																												
$0.50 \leq \Phi$	0																												
5.5	Polarizer defect.	<p>5.4.1 Polarizer Position</p> <p>(i) Shifting in position should not exceed the glass outline dimension.</p> <p>(ii) Incomplete covering of the viewing area due to shifting is not allowed.</p> <p>5.4.2 Dirt on polarizer</p> <p>Dirt which can be wiped easily should be accepted.</p> <p>5.4.3 Polarizer Nick & Dent</p> <table border="1" style="width:100%; border-collapse: collapse; text-align: center;"> <tr> <th rowspan="3">Sizes(mm)</th> <th colspan="3">Acceptable Qty</th> </tr> <tr> <th colspan="3">Zone</th> </tr> <tr> <th>A</th> <th>B</th> <th>C</th> </tr> <tr> <td>$\Phi < 0.25$</td> <td colspan="2">Acceptable</td> <td rowspan="3" style="writing-mode: vertical-rl; text-orientation: mixed;">Acceptable</td> </tr> <tr> <td>$0.25 \leq \Phi \leq 0.5$</td> <td colspan="2">$N \leq 4$</td> </tr> <tr> <td>$\Phi > 0.5$</td> <td colspan="2">0</td> </tr> </table>	Sizes(mm)	Acceptable Qty			Zone			A	B	C	$\Phi < 0.25$	Acceptable		Acceptable	$0.25 \leq \Phi \leq 0.5$	$N \leq 4$		$\Phi > 0.5$	0		Minor						
Sizes(mm)	Acceptable Qty																												
	Zone																												
	A	B	C																										
$\Phi < 0.25$	Acceptable		Acceptable																										
$0.25 \leq \Phi \leq 0.5$	$N \leq 4$																												
$\Phi > 0.5$	0																												

 OUTGOING QUALITY STANDARD	PAGE 4 OF 8
--	-------------

TITLE:FUNCTIONAL TEST & INSPECTION CRITERIA

5. Minor Defect

Item No	Items to be inspected	Inspection Standard	Classification of defects																										
5.6	Polarizer defect	<p>5.4.4 Air bubbles between glass & polarizer:</p> <table border="1" style="margin-left: auto; margin-right: auto; border-collapse: collapse;"> <thead> <tr> <th rowspan="3" style="width: 30%;">Size(mm)</th> <th colspan="3" style="text-align: center;">Acceptable Qty</th> </tr> <tr> <th colspan="3" style="text-align: center;">Zone</th> </tr> <tr> <th style="width: 10%;">A</th> <th style="width: 10%;">B</th> <th style="width: 10%;">C</th> </tr> </thead> <tbody> <tr> <td style="text-align: center;">$\Phi \leq 0.3$</td> <td colspan="2" style="text-align: center;">Acceptable</td> <td rowspan="4" style="text-align: center; vertical-align: middle;">Acceptable</td> </tr> <tr> <td style="text-align: center;">$0.3 < \Phi \leq 1.0$</td> <td colspan="2" style="text-align: center;">3</td> </tr> <tr> <td style="text-align: center;">$1.0 < \Phi \leq 1.5$</td> <td colspan="2" style="text-align: center;">1</td> </tr> <tr> <td style="text-align: center;">$\Phi > 1.5$</td> <td colspan="2" style="text-align: center;">0</td> </tr> </tbody> </table>	Size(mm)	Acceptable Qty			Zone			A	B	C	$\Phi \leq 0.3$	Acceptable		Acceptable	$0.3 < \Phi \leq 1.0$	3		$1.0 < \Phi \leq 1.5$	1		$\Phi > 1.5$	0		Minor			
		Size(mm)		Acceptable Qty																									
Zone																													
A	B		C																										
$\Phi \leq 0.3$	Acceptable		Acceptable																										
$0.3 < \Phi \leq 1.0$	3																												
$1.0 < \Phi \leq 1.5$	1																												
$\Phi > 1.5$	0																												
		<p>5.4.5 Polarizer scratch</p> <p>(i) If the Polarizer scratch can be seen after cover assembling or in the operating condition, judge by the line defect of 5.4.</p> <p>(ii) If the Polarizer scratch can be seen only in non-operating condition or some special angle, judge by the following.</p> <table border="1" style="margin-left: auto; margin-right: auto; border-collapse: collapse;"> <thead> <tr> <th colspan="2" style="text-align: center;">Size(mm)</th> <th colspan="3" style="text-align: center;">Acceptable Qty</th> </tr> <tr> <th rowspan="2" style="width: 15%;">L(Length)</th> <th rowspan="2" style="width: 15%;">W(Width)</th> <th colspan="3" style="text-align: center;">Zone</th> </tr> <tr> <th style="width: 10%;">A</th> <th style="width: 10%;">B</th> <th style="width: 10%;">C</th> </tr> </thead> <tbody> <tr> <td style="text-align: center;">Ignore</td> <td style="text-align: center;">$W \leq 0.02$</td> <td colspan="2" style="text-align: center;">Ignore</td> <td rowspan="3" style="text-align: center; vertical-align: middle;">Ignore</td> </tr> <tr> <td style="text-align: center;">$1.0 < L \leq 5.0$</td> <td style="text-align: center;">$0.02 < W \leq 0.2$</td> <td colspan="2" style="text-align: center;">$N \leq 4.$</td> </tr> <tr> <td style="text-align: center;">$5.0 < L$</td> <td style="text-align: center;">$0.2 < W$</td> <td colspan="2" style="text-align: center;">0</td> </tr> </tbody> </table>	Size(mm)		Acceptable Qty			L(Length)	W(Width)	Zone			A	B	C	Ignore	$W \leq 0.02$	Ignore		Ignore	$1.0 < L \leq 5.0$	$0.02 < W \leq 0.2$	$N \leq 4.$		$5.0 < L$	$0.2 < W$	0		Minor
Size(mm)		Acceptable Qty																											
L(Length)	W(Width)	Zone																											
		A	B	C																									
Ignore	$W \leq 0.02$	Ignore		Ignore																									
$1.0 < L \leq 5.0$	$0.02 < W \leq 0.2$	$N \leq 4.$																											
$5.0 < L$	$0.2 < W$	0																											

	OUTGOING QUALITY STANDARD	PAGE 5 OF 8
--	----------------------------------	-------------

TITLE:FUNCTIONAL TEST & INSPECTION CRITERIA

5. Minor Defect

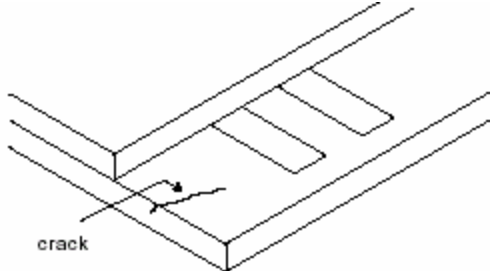
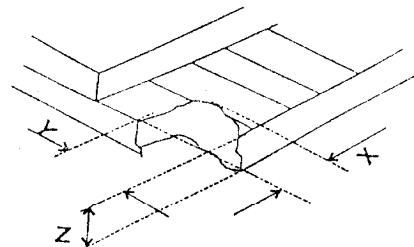
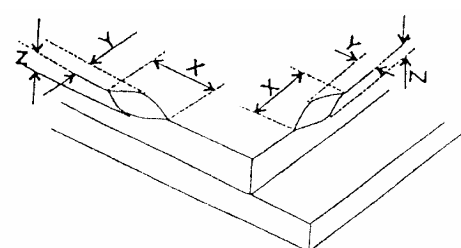
Item No	Items to be inspected	Inspection Standard	Classification of defects								
5.7	Glass defect	(i) Crack Cracks are not allowed. 	Minor								
		(ii) TFT chips on corner  <table border="1" style="width: 100%; border-collapse: collapse; text-align: center;"> <thead> <tr> <th style="width: 25%;">X</th> <th style="width: 25%;">Y</th> <th style="width: 25%;">Z</th> <th style="width: 25%;">Acceptable</th> </tr> </thead> <tbody> <tr> <td>≤ 3.0</td> <td>≤ 3.0</td> <td>Not more than the thickness of glass.</td> <td>$N \leq 3.$</td> </tr> </tbody> </table> Chips on the corner of terminal shall not be allowed to extend into the ITO pad or expose perimeter seal.	X	Y	Z	Acceptable	≤ 3.0	≤ 3.0	Not more than the thickness of glass.	$N \leq 3.$	Minor
		X	Y	Z	Acceptable						
≤ 3.0	≤ 3.0	Not more than the thickness of glass.	$N \leq 3.$								
(iii) Usual surface cracks  <table border="1" style="width: 100%; border-collapse: collapse; text-align: center;"> <thead> <tr> <th style="width: 25%;">X</th> <th style="width: 25%;">Y</th> <th style="width: 25%;">Z</th> <th style="width: 25%;">Acceptable</th> </tr> </thead> <tbody> <tr> <td>≤ 1.5</td> <td>≤ 1.5</td> <td>Not more than the thickness of glass.</td> <td>$N \leq 4.$</td> </tr> </tbody> </table> It is only applicable to the upper glass of LCD.	X	Y	Z	Acceptable	≤ 1.5	≤ 1.5	Not more than the thickness of glass.	$N \leq 4.$	Minor		
X	Y	Z	Acceptable								
≤ 1.5	≤ 1.5	Not more than the thickness of glass.	$N \leq 4.$								

 OUTGOING QUALITY STANDARD	PAGE 6 OF 8
--	--------------------

TITLE:FUNCTIONAL TEST & INSPECTION CRITERIA

6. TP Cosmetic Defect.

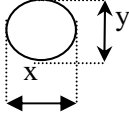
Item No	Items to be inspected	Inspection Standard	Classification of defects																								
6.1	Black and white Spot defect Foreign Particle,	<p>For dark/white spot, size Φ is defined as $\Phi = \frac{(x+y)}{2}$</p>  <table border="1" style="width:100%; border-collapse: collapse; margin-top: 10px;"> <thead> <tr> <th rowspan="2" style="width: 20%;">Zone Size(mm)</th> <th colspan="3">Acceptable Qty</th> </tr> <tr> <th style="width: 15%;">A</th> <th style="width: 15%;">B+C</th> <th style="width: 50%;"></th> </tr> </thead> <tbody> <tr> <td>$\Phi \leq 0.15$</td> <td colspan="2" style="text-align: center;">Ignore</td> <td rowspan="4" style="text-align: center; vertical-align: middle;">distance 5mm over</td> </tr> <tr> <td>$0.15 < \Phi \leq 0.25$</td> <td colspan="2" style="text-align: center;">6</td> </tr> <tr> <td>$0.25 < \Phi \leq 0.50$</td> <td colspan="2" style="text-align: center;">4</td> </tr> <tr> <td>$\Phi > 0.5$</td> <td colspan="2" style="text-align: center;">0</td> </tr> <tr> <td colspan="4" style="text-align: center;">Total defective dots shall not exceed 6 pcs on the same TP.</td> </tr> </tbody> </table>	Zone Size(mm)	Acceptable Qty			A	B+C		$\Phi \leq 0.15$	Ignore		distance 5mm over	$0.15 < \Phi \leq 0.25$	6		$0.25 < \Phi \leq 0.50$	4		$\Phi > 0.5$	0		Total defective dots shall not exceed 6 pcs on the same TP.				Minor
Zone Size(mm)	Acceptable Qty																										
	A	B+C																									
$\Phi \leq 0.15$	Ignore		distance 5mm over																								
$0.15 < \Phi \leq 0.25$	6																										
$0.25 < \Phi \leq 0.50$	4																										
$\Phi > 0.5$	0																										
Total defective dots shall not exceed 6 pcs on the same TP.																											

Item No	Items to be inspected	Inspection Standard	Classification of defects																															
6.2	Black line, White line, Scratch, Foreign material under film,	<table border="1" style="width:100%; border-collapse: collapse; margin-top: 10px;"> <thead> <tr> <th colspan="2">Size(mm)</th> <th colspan="3">Acceptable Qty</th> </tr> <tr> <th rowspan="2" style="width: 20%;">L(Length)</th> <th rowspan="2" style="width: 20%;">W(Width)</th> <th colspan="3">Zone</th> </tr> <tr> <th style="width: 10%;">A</th> <th style="width: 10%;">B+C</th> <th style="width: 60%;"></th> </tr> </thead> <tbody> <tr> <td style="text-align: center;">Ignore</td> <td style="text-align: center;">$W \leq 0.03$</td> <td colspan="3" style="text-align: center;">Ignore</td> </tr> <tr> <td style="text-align: center;">$L \leq 5.0$</td> <td style="text-align: center;">$0.03 < W \leq 0.05$</td> <td colspan="2" style="text-align: center;">5</td> <td rowspan="3" style="text-align: center; vertical-align: middle;">distance 5mm over</td> </tr> <tr> <td style="text-align: center;">$L \leq 5.0$</td> <td style="text-align: center;">$0.05 < W \leq 0.1$</td> <td colspan="2" style="text-align: center;">2</td> </tr> <tr> <td></td> <td style="text-align: center;">$0.1 < W$</td> <td colspan="2" style="text-align: center;">0</td> </tr> </tbody> </table>	Size(mm)		Acceptable Qty			L(Length)	W(Width)	Zone			A	B+C		Ignore	$W \leq 0.03$	Ignore			$L \leq 5.0$	$0.03 < W \leq 0.05$	5		distance 5mm over	$L \leq 5.0$	$0.05 < W \leq 0.1$	2			$0.1 < W$	0		Minor
Size(mm)		Acceptable Qty																																
L(Length)	W(Width)	Zone																																
		A	B+C																															
Ignore	$W \leq 0.03$	Ignore																																
$L \leq 5.0$	$0.03 < W \leq 0.05$	5		distance 5mm over																														
$L \leq 5.0$	$0.05 < W \leq 0.1$	2																																
	$0.1 < W$	0																																

OUTGOING QUALITY STANDARD		PAGE 7 OF 8							
TITLE:FUNCTIONAL TEST & INSPECTION CRITERIA									
6. TP Cosmetic Defect									
Item No	Items to be inspected	Inspection Standard	Classification of defects						
6.3	TP defect	(i) Chips on corner <table border="1" style="margin-left: auto; margin-right: auto;"> <thead> <tr> <th>X(mm)</th> <th>Y(mm)</th> <th>Z(mm)</th> </tr> </thead> <tbody> <tr> <td>≤3.0</td> <td>≤3.0</td> <td>Z<T</td> </tr> </tbody> </table>	X(mm)	Y(mm)	Z(mm)	≤3.0	≤3.0	Z<T	Minor
		X(mm)	Y(mm)	Z(mm)					
		≤3.0	≤3.0	Z<T					
(ii) Usual surface cracks <table border="1" style="margin-left: auto; margin-right: auto;"> <thead> <tr> <th>X(mm)</th> <th>Y(mm)</th> <th>Z(mm)</th> </tr> </thead> <tbody> <tr> <td>≤6.0</td> <td><2.0</td> <td>Z<T</td> </tr> </tbody> </table>	X(mm)	Y(mm)	Z(mm)	≤6.0	<2.0	Z<T	Minor		
X(mm)	Y(mm)	Z(mm)							
≤6.0	<2.0	Z<T							
(iii) Crack Cracks tending to break are not allowed. 	Major								
6.4	Total number of dots	The total number of luminous dots, dark dots, contamination particles, bubbles, scratch defects, pinholes must not exceed 10 /piece on the same TP.							

 OUTGOING QUALITY STANDARD	PAGE 8 OF 8
--	--------------------

TITLE:FUNCTIONAL TEST & INSPECTION CRITERIA

8. Module Cosmetic Criteria

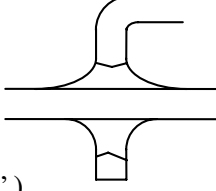
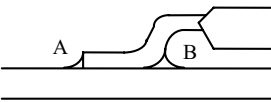
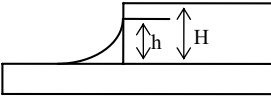
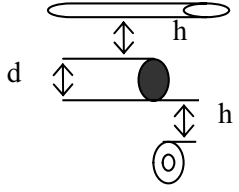
Item No	Items to be inspected	Inspection Standard	Classification of defects
1	Difference in Spec.	None allowed	Major
2	Pattern peeling	No substrate pattern peeling and floating	Major
3	Soldering defects	No soldering missing No soldering bridge No cold soldering	Major Major Minor
4	Resist flaw on Printed Circuit Boards	visible copper foil (Ø0.5mm or more) on substrate pattern.	Minor
5	Accretion of metallic Foreign matter	No accretion of metallic foreign matters (Not exceed Ø0.2mm).	Minor Minor
6	Stain	No stain to spoil cosmetic badly.	Minor
7	Plate discoloring	No plate fading, rusting and discoloring.	Minor
8	Solder amount 1. Lead parts	a. Soldering side of PCB Solder to form a 'Filet' all around the lead. Solder should not hide the lead form perfectly. (too much) 	Minor
	2. Flat packages	b. Components side (In case of 'Through Hole PCB') Solder to reach the Components side of PCB. 	Minor
	3. Chips	$(3/2) H \geq h \geq (1/2) H$ 	Minor
9	Solder ball/Solder splash	a.The spacing between solder ball and the conductor or solder pad $h \geq 0.13\text{mm}$.The diameter of solder ball $d \leq 0.15\text{mm}$.  b.The quantity of solder balls or solder. Splashes isn't beyond 5 in 600 mm ² . c.Solder balls/Solder splashes do not violate minimum electrical clearance. d.Solder balls/Solder splashes must be entrapped / encapsulated or attached to the metal surface . Note: Entrapped/encapsulated/attached is intended to mean that normal service environment of the product will not cause a solder ball to become dislodged.	Minor Minor Major Minor

■ PRECAUTIONS FOR USING LCD MODULES

Handling Precautions

(1) The display panel is made of glass and polarizer. As glass is fragile. It tends to become or chipped during handling especially on the edges. Please avoid dropping or jarring. Do not subject it to a mechanical shock by dropping it or impact.

(2) If the display panel is damaged and the liquid crystal substance leaks out, be sure not to get any in your mouth. If the substance contacts your skin or clothes, wash it off using soap and water.

(3) Do not apply excessive force to the display surface or the adjoining areas since this may cause the color tone to vary. Do not touch the display with bare hands. This will stain the display area and degraded insulation between terminals (some cosmetics are determined to the polarizer).

(4) The polarizer covering the display surface of the LCD module is soft and easily scratched. Handle this polarizer carefully. Do not touch, push or rub the exposed polarizers with anything harder than an HB pencil lead (glass, tweezers, etc.). Do not put or attach anything on the display area to avoid leaving marks on. Condensation on the surface and contact with terminals due to cold will damage, stain or dirty the polarizer. After products are tested at low temperature they must be warmed up in a container before coming is contacting with room temperature air.

(5) If the display surface becomes contaminated, breathe on the surface and gently wipe it with a soft dry cloth. If it is heavily contaminated, moisten cloth with one of the following solvents

- Isopropyl alcohol
- Ethyl alcohol

Do not scrub hard to avoid damaging the display surface.

(6) Solvents other than those above-mentioned may damage the polarizer. Especially, do not use the following.

- Water
- Ketone
- Aromatic solvents

Wipe off saliva or water drops immediately, contact with water over a long period of time may cause deformation or color fading. Avoid contacting oil and fats.

(7) Exercise care to minimize corrosion of the electrode. Corrosion of the electrodes is accelerated by water droplets, moisture condensation or a current flow in a high-humidity environment.

(8) Install the LCD Module by using the mounting holes. When mounting the LCD module make sure it is free of twisting, warping and distortion. In particular, do not forcibly pull or bend the I/O cable or the backlight cable.

(9) Do not attempt to disassemble or process the LCD module.

(10) NC terminal should be open. Do not connect anything.

(11) If the logic circuit power is off, do not apply the input signals.

(12) Electro-Static Discharge Control, Since this module uses a CMOS LSI, the same careful attention should be paid to electrostatic discharge as for an ordinary CMOS IC. To prevent destruction of the elements by static electricity, be careful to maintain an optimum work environment.

- Before remove LCM from its packing case or incorporating it into a set, be sure the module and your body have the same electric potential. Be sure to ground the body when handling the LCD modules.

- Tools required for assembling, such as soldering irons, must be properly grounded. make certain the AC power source for the soldering iron does not leak. When using an electric screwdriver to attach LCM, the screwdriver should be of ground potentiality to minimize as much as possible any transmission of electromagnetic waves produced sparks coming from the commutator of the motor.

- To reduce the amount of static electricity generated, do not conduct assembling and other work under dry conditions. To reduce the generation of static electricity be careful that the air in the work is not too dried. A relative humidity of 50%-60% is recommended. As far as possible make the electric potential of your work clothes and that of the work bench the ground potential

- The LCD module is coated with a film to protect the display surface. Exercise care when peeling off this protective film since static electricity may be generated

(13) Since LCM has been assembled and adjusted with a high degree of precision, avoid applying excessive shocks to the module or making any alterations or modifications to it.

- Do not alter, modify or change the shape of the tab on the metal frame.
- Do not make extra holes on the printed circuit board, modify its shape or change the positions of components to be attached.
- Do not damage or modify the pattern writing on the printed circuit board.
- Absolutely do not modify the zebra rubber strip (conductive rubber) or heat seal connector.
- Except for soldering the interface, do not make any alterations or modifications with a soldering iron.
- Do not drop, bend or twist LCM.

Storage Precautions

When storing the LCD modules, the following precaution is necessary.

- (1) Store them in a sealed polyethylene bag. If properly sealed, there is no need for the dessicant.
- (2) Store them in a dark place. Do not expose to sunlight or fluorescent light, keep the temperature between 0°C and 35°C.
- (3) The polarizer surface should not come in contact with any other objects. (We advise you to store them in the container in which they were shipped).

Others

Liquid crystals solidify under low temperature (below the storage temperature range) leading to defective orientation or the generation of air bubbles (black or white). Air bubbles may also be generated if the module is subject to a low temperature.

If the LCD modules have been operating for a long time showing the same display patterns, the display patterns may remain on the screen as ghost images and a slight contrast irregularity may also appear. A normal operating status can be regained by suspending use for some time. It should be noted that this phenomenon does not adversely affect performance reliability.

To minimize the performance degradation of the LCD modules resulting from destruction caused by static electricity etc., exercise care to avoid holding the following sections when handling the modules.

- Exposed area of the printed circuit board.
- Terminal electrode sections.

Handling precaution for LCM

LCM is easy to be damaged.
Please note below and be careful for handling!

Correct handling:



As above picture, please handle with anti-static gloves around LCM edges.

Incorrect handling:

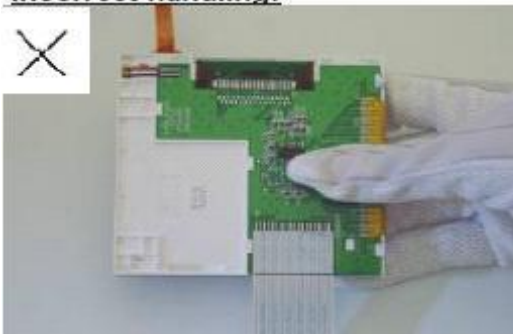

Please don't touch IC directly.

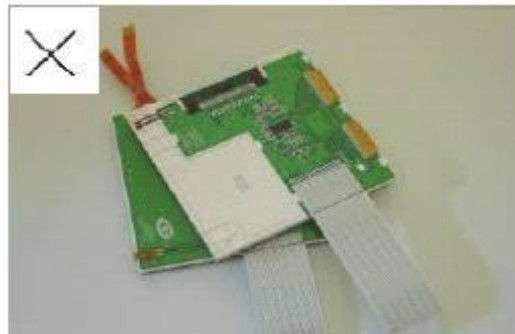

Please don't stack LCM.

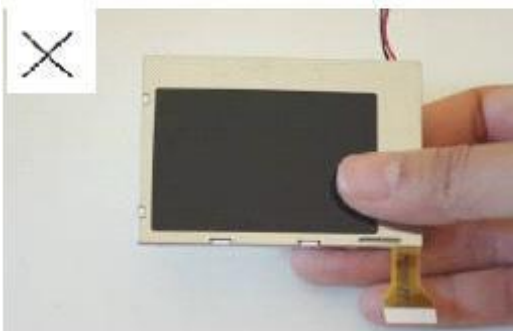

Please don't hold the surface of panel.

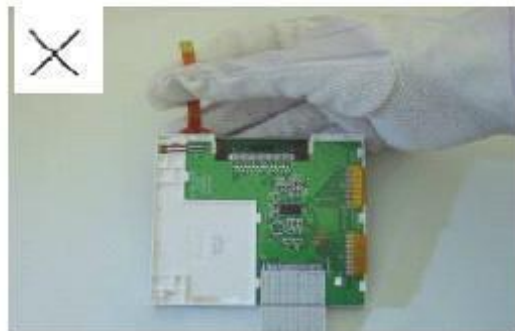

Please don't stretch interface of output, such as FPC cable.

Handling precaution for LCD

LCD is easy to be damaged.
Please note below and be careful for handling!

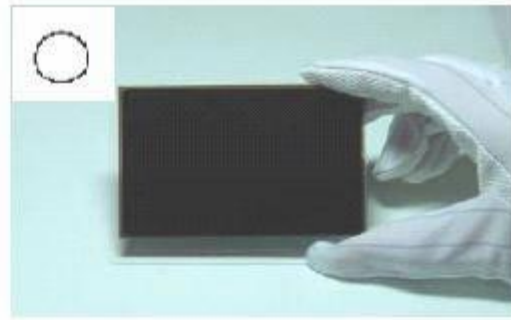
Correct handling:

As above photo, please handle with anti-static gloves around LCD edges.

Incorrect handling:

Please don't stack the LCDS.

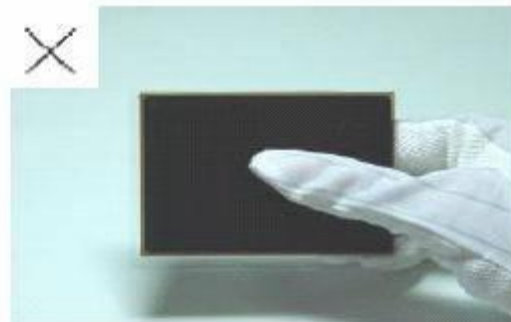

Please don't hold the surface of LCD.

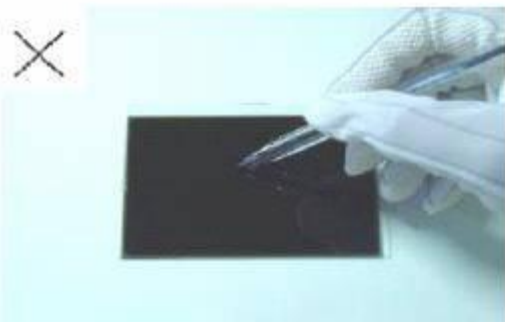

Please don't operate with sharp stick such as pens.

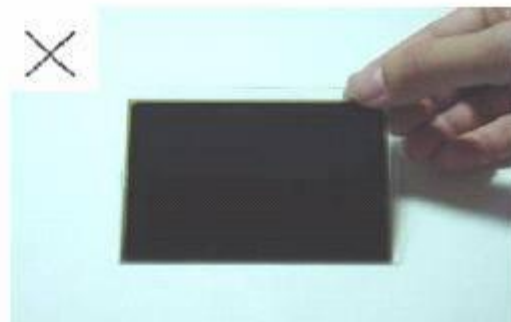

Please don't touch ITO glass without anti-static gloves.

Storage Precautions

When storing the LCD modules, the following precaution is necessary.

- (1) Store them in a sealed polyethylene bag. If properly sealed, there is no need for the dessicant.
- (2) Store them in a dark place. Do not expose to sunlight or fluorescent light, keep the temperature between 0°C and 35°C, and keep the relative humidity between 40%RH and 60%RH.
- (3) The polarizer surface should not come in contact with any other objects. (We advise you to store them in the anti-static electricity container in which they were shipped.

Others

Liquid crystals solidify under low temperature (below the storage temperature range) leading to defective orientation or the generation of air bubbles (black or white). Air bubbles may also be generated if the module is subject to a low temperature.

If the LCD modules have been operating for a long time showing the same display patterns, the display patterns may remain on the screen as ghost images and a slight contrast irregularity may also appear. A normal operating status can be regained by suspending use for some time. It should be noted that this phenomenon does not adversely affect performance reliability.

To minimize the performance degradation of the LCD modules resulting from destruction caused by static electricity etc., exercise care to avoid holding the following sections when handling the modules.

- Exposed area of the printed circuit board.
- Terminal electrode sections.

USING LCD MODULES

Installing LCD Modules

The hole in the printed circuit board is used to fix LCM as shown in the picture below. Attend to the following items when installing the LCM.

- (1) Cover the surface with a transparent protective plate to protect the polarizer and LC cell.

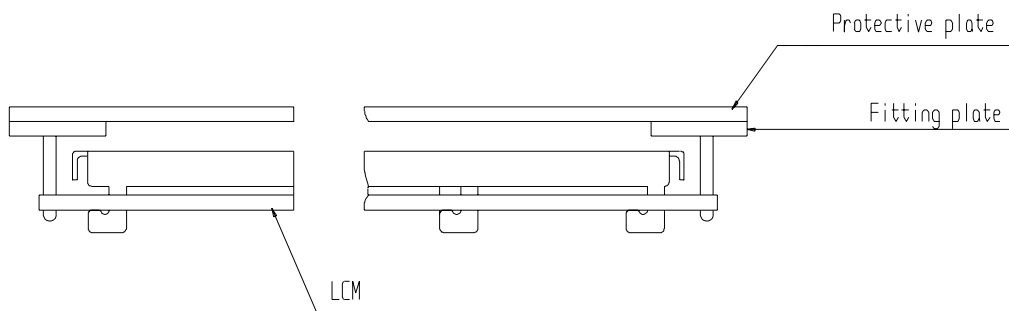

- (2) When assembling the LCM into other equipment, the spacer to the bit between the LCM and the fitting plate should have enough height to avoid causing stress to the module surface, refer to the individual specifications for measurements. The measurement tolerance should be $\pm 0.1\text{mm}$.

Precaution for assemble the module with BTB connector:

Please note the position of the male and female connector position, don't assemble or assemble like the method which the following picture shows

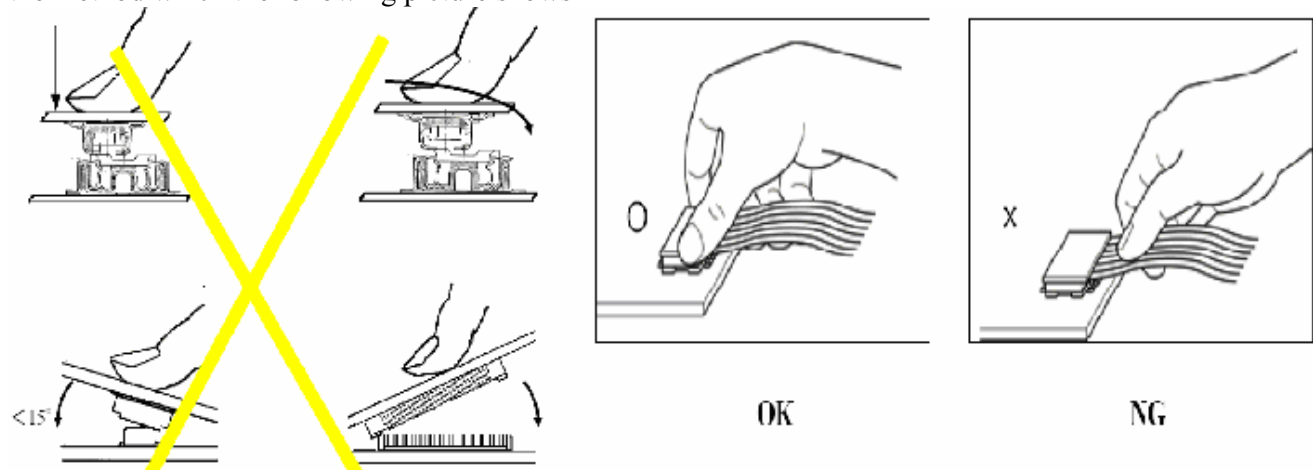

Precaution for soldering to the LCM

	Hand soldering	Machine drag soldering	Machine press soldering
No ROHS product	290°C ~350°C. Time : 3-5S.	330°C ~350°C. Speed : 4-8 mm/s.	300°C ~330°C. Time : 3-6S. Press: 0.8~1.2Mpa
ROHS product	340°C ~370°C. Time : 3-5S.	350°C ~370°C. Time : 4-8 mm/s.	330°C ~360°C. Time : 3-6S. Press: 0.8~1.2Mpa

(1) If soldering flux is used, be sure to remove any remaining flux after finishing to soldering operation. (This does not apply in the case of a non-halogen type of flux.) It is recommended that you protect the LCD surface with a cover during soldering to prevent any damage due to flux spatters.

(2) When soldering the electroluminescent panel and PC board, the panel and board should not be detached more than three times. This maximum number is determined by the temperature and time conditions mentioned above, though there may be some variance depending on the temperature of the soldering iron.

(3) When remove the electroluminescent panel from the PC board, be sure the solder has completely melted, the soldered pad on the PC board could be damaged.

Precautions for Operation

(1) Viewing angle varies with the change of liquid crystal driving voltage (VLCD). Adjust VLCD to show the best contrast.

(2) It is an indispensable condition to drive LCD's within the specified voltage limit since the higher voltage then the limit cause the shorter LCD life. An electrochemical reaction due to direct current causes LCD's undesirable deterioration, so that the use of direct current drive should be avoided.

(3) Response time will be extremely delayed at lower temperature than the operating temperature range and on the other hand at higher temperature LCD's show dark color in them. However those phenomena do not mean malfunction or out of order with LCD's, Which will come back in the specified operating temperature.

(4) If the display area is pushed hard during operation, the display will become abnormal. However, it will return to normal if it is turned off and then back on.

(5) A slight dew depositing on terminals is a cause for electro-chemical reaction resulting in terminal open circuit. Usage under the maximum operating temperature, 50%RH or less is required.

(6) Input each signal after the positive/negative voltage becomes stable.

(7) Please keep the temperature within specified range for use and storage. Polarization degradation, bubble generation or polarizer peel-off may occur with high temperature and high humidity.

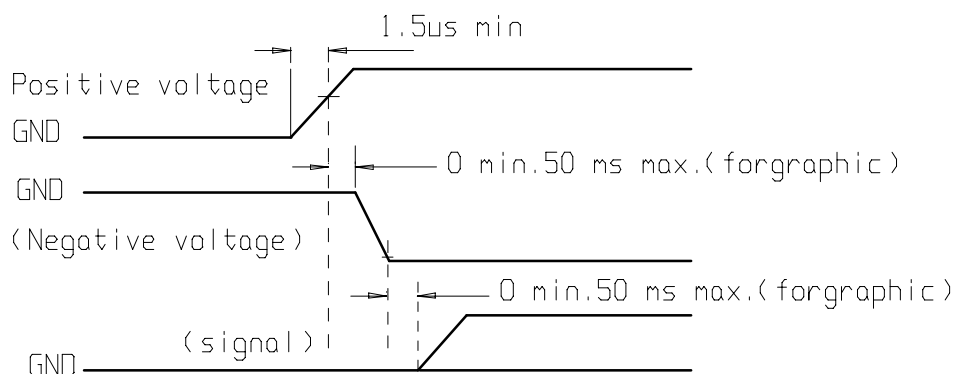

Safety

(1) It is recommended to crush damaged or unnecessary LCDs into pieces and wash them off with solvents such as acetone and ethanol, which should later be burned.

(2) If any liquid leaks out of a damaged glass cell and comes in contact with the hands, wash off thoroughly with soap and water.

Limited Warranty

Unless agreed between Multi-Inno and customer, Multi-Inno will replace or repair any of its LCD modules which are found to be functionally defective when inspected in accordance with Multi-Inno LCD acceptance standards (copies available upon request) for a period of one year from date of production. Cosmetic/visual defects must be returned to Multi-Inno within 90 days of shipment. Confirmation of such date shall be based on data code on product. The warranty liability of Multi-Inno limited to repair and/or replacement on the terms set forth above. Multi-Inno will not be responsible for any subsequent or consequential events.

Return LCM under warranty

No warranty can be granted if the precautions stated above have been disregarded. The typical examples of violations are :

- Broken LCD glass.
- PCB eyelet is damaged or modified.
- PCB conductors damaged.
- Circuit modified in any way, including addition of components.
- PCB tampered with by grinding, engraving or painting varnish.
- Soldering to or modifying the bezel in any manner.

Module repairs will be invoiced to the customer upon mutual agreement. Modules must be returned with sufficient description of the failures or defects. Any connectors or cable installed by the customer must be removed completely without damaging the PCB eyelet, conductors and terminals.

■ PRIOR CONSULT MATTER

- 1.①For Multi-Inno standard products, we keep the right to change material, process ... for improving the product property without notice on our customer.
②For OEM products, if any change needed which may affect the product property, we will consult with our customer in advance.
2. If you have special requirement about reliability condition, please let us know before you start the test on our samples.