



MULTI-INNO TECHNOLOGY CO., LTD.

www.multi-inno.com

LCD MODULE SPECIFICATION

Model : MI0350ADT-3

This module uses ROHS material

For Customer's Acceptance:

Customer	
Approved	
Comment	

This specification may change without prior notice in order to improve performance or quality. Please contact Multi-Inno for updated specification and product status before design for this product or release of this order.

Revision	1.0
Engineering	
Date	2013-08-20
Our Reference	



REVISION RECORD

REV NO.	REV DATE	CONTENTS	REMARKS
1.0	2013-08-20	First release	



CONTENTS

- GENERAL INFORMATION
- EXTERNAL DIMENSIONS
- ABSOLUTE MAXIMUM RATINGS
- ELECTRICAL CHARACTERISTICS
- TOUCH PANEL SPECIFICATIONS
- ELECTRO-OPTICAL CHARACTERISTICS
- INTERFACE DESCRIPTION
- BLOCK DIAGRAM
- APPLICATION CIRCUIT
- RELIABILITY TEST
- INSPECTION CRITERION
- PRECAUTIONS FOR USING LCD MODULES
- USING LCD MODULES
- PRIOR CONSULT MATTER

**■ GENERAL INFORMATION**

Item	Contents	Unit
LCD type	TFT/Transmissive	/
Size	3.5	Inch
Viewing direction	12:00	O'Clock
Gray scale inversion direction	6:00	O'Clock
Module area (W × H×T)	76.9×63.9×4.25	mm ³
Active area (W×H)	70.08×52.56	mm ²
Number of dots	320(RGB)×240	/
Driver IC	SSD2119	/
Interface type	1. 8/9/16/18-bit 6800-series/8080-series Parallel Interface 2. Serial Peripheral Inerface(SPI) 3. 18-/16-bit RGB interface(OE,DOTCLK, HSYNC, VSYNC, DB[17:0]) 4. VSYNC interface(system interface+VSYNC) 5. WSYNC interface(system interface+WSYNC)	/
Pixel arrangement	RGB vertical stripe	/
Input voltage	3.3	V
Backlight type	6 LEDs	/
Colors	262K	/
With/Without TSP	With T/P	/
Weight	TBD	g

Note 1:Viewing direction for best image quality is different from TFT definition, there is a 180 degree shift.

Note 2 : RoHS compliant;

Note 3: LCM weight tolerance: ± 5% .

EXTERNAL DIMENSIONS

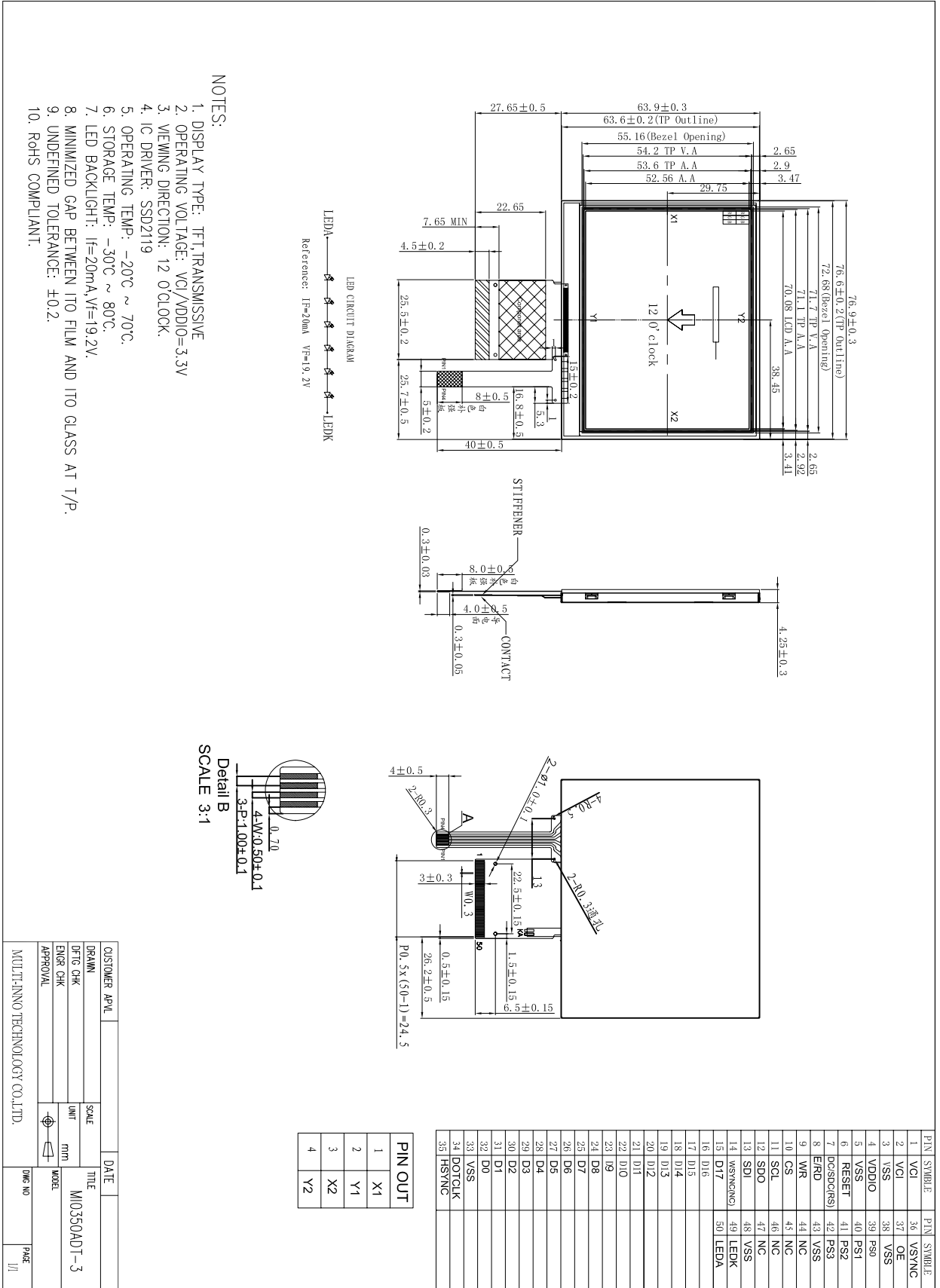

- NOTES:
1. DISPLAY TYPE: TFT, TRANSMISSIVE
 2. OPERATING VOLTAGE: VCI/VDDIO=3.3V
 3. VIEWING DIRECTION: 12 O'CLOCK.
 4. IC DRIVER: SSD2119
 5. OPERATING TEMP: -20°C ~ 70°C.
 6. STORAGE TEMP: -30°C ~ 80°C.
 7. LED BACKLIGHT: IF=20mA, VF=1.9, 2V.
 8. MINIMIZED GAP BETWEEN ITO FILM AND ITO GLASS AT T/P.
 9. UNDEFINED TOLERANCE: ±0.2.
 10. ROHS COMPLIANT.

Detail B
SCALE 3:1

CUSTOMER APPL	SCALE	DATE
DRAWN	UNIT	TITLE
DEFS CHK	MM	MI0350ADT-3
ENGR CHK	MODEL	
APPROVAL		
MULTI-INNO TECHNOLOGY CO.,LTD.	FIG NO	PAGE
		1/1

PIN OUT	
1	X1
2	Y1
3	X2
4	Y2

PIN	SYMBOL	PIN	SYMBOL
1	VCI	36	VSYNC
2	VCI	37	OE
3	VSS	38	VSS
4	VDDIO	39	PS0
5	VSS	40	PS1
6	RESET	41	PS2
7	DCSD(CRS)	42	PS3
8	E/RD	43	VSS
9	WR	44	NC
10	CS	45	NC
11	SOCL	46	NC
12	SDO	47	NC
13	SDI	48	VSS
14	MSG(CMG)	49	LEDK
15	D17	50	LEDA
16	D16		
17	D15		
18	D14		
19	D13		
20	D12		
21	D11		
22	D10		
23	D9		
24	D8		
25	D7		
26	D6		
27	D5		
28	D4		
29	D3		
30	D2		
31	D1		
32	DO		
33	VSS		
34	DOTCLK		
35	HSYNC		

**■ABSOLUTE MAXIMUM RATINGS**

Parameter	Symbol	Min	Max	Unit
Supply voltage	V _{CI}	-0.3	4.0	V
Input voltage for logic	V _{DDIO}	-0.5	V _{CC} +0.3	V
Supply current(One LED)	I _{LED}	-	30	mA
Operatingtemperature	Top	-20	70	°C
Storagetemperature	TST	-30	80	°C
Humidity	RH	-	90%(Max60°C)	RH

■ELECTRICAL CHARACTERISTICS

DC CHARACTERISTICS

Parameter	Symbol	Min	Typ	Max	Unit
Supply voltage for logic	V _{CI}	2.5	3.3	3.6	V
Inputvoltage'H'level	V _{IH}	0.8V _{CI}	-	V _{CI}	V
Inputvoltage'L'level	V _{IL}	-0.3	-	0.2V _{CI}	V
Input leakage current	I _{LKG}	-	-	-	μ A
LED forward voltage	V _f	3.0	3.2	3.4	V
Input backlight current(one LED)	I _{LED}	-	20	25	mA
LED life time	-	30,000	50,000	-	Hr

■TOUCH PANEL SPECIFICATIONS

ELECTRICAL CHARACTERISTICS

ITEM	SPECIFICATIONS			UNIT	REMARK
	MIN.	TYP.	MAX		
Linearity	-1.5	-	1.5	%	After environment & life test
Terminal Resistance	200	-	900	ohm	X(Film side)
	150	-	600	ohm	Y(Glass side)
Insulation Resistance	10	-	-	Mohm	DC 25V 1min
Operating Voltage	-	5	-	V	DC

OPTICAL CHARACTERISTICS

ITEM	SPECIFICATIONS			UNIT	REMARK
	MIN.	TYP.	MAX		
Response Time	-	-	10	ms	100kohm pull-up
Light Transparency	78	-	-	%	



MECHANICAL CHARACTERISTICS

ITEM	SPECIFICATIONS			UNIT	REMARK
	MIN.	TYP.	MAX		
Operation Force	-	-	80	gf	Note1
Surface Hardness	3	-	-	H	
Pen Sliding Durability	100,000			times	Note2
Hitting Durability	1,000,000			times	Note3

Note 1: Do not operate it with a thing except a polyacetal pen (tip R0.8mm or less) or a finger, especially those with hard or sharp tips such as a ball point pen or a mechanical pencil.

Depending on the pitch & the dimension of the spacer dots in between.

Note 2: Measurement for surface area.

-Scratch 100,000 times straight line on the film with a stylus change every 20,000 times.

-Force: 100gf.

-Speed: 60mm/sec.

-Stylus: R0.8 polyacetal tip.

Note 3: Hit 1,000,000 times on the film with an R12.5mm tip.

-Force: 250gf.

-Speed: 2 times/sec.

■ELECTRO-OPTICAL CHARACTERISTICS

Item	Symbol	Condition	Min	Typ	Max	Unit	Remark	Note
Response time	Tr +Tf	$\theta=0^\circ$ $\varnothing=0^\circ$ $T_a=25^\circ\text{C}$	-	25	35	ms	Fig.1	4
Contrastratio	Cr		320	400	-	---	FIG 2.	1
Luminance uniformity	δ WHITE		80	85	-	%	FIG 2.	3
Surface Luminance	Lv		-	280	-	cd/m ²	FIG 2.	2
Viewing angle range	θ	$\varnothing = 90^\circ$	25	40	-	deg	FIG 3.	6
		$\varnothing = 270^\circ$	45	60	-	deg	FIG 3.	
		$\varnothing = 0^\circ$	45	60	-	deg	FIG 3.	
		$\varnothing = 180^\circ$	45	60	-	deg	FIG 3.	
CIE (x, y) chromaticity	Red x	$\theta=0^\circ$ $\varnothing=0^\circ$ $T_a=25^\circ\text{C}$	-	0.633	-		FIG 2.	5
	Red y		-	0.329	-			
	Green x		-	0.297	-			
	Green y		-	0.577	-			
	Blue x		-	0.133	-			
	Blue y		-	0.129	-			
	White x		-	0.294	-			
	White y		-	0.334	-			

Note 1. Contrast Ratio(CR) is defined mathematically as For more information see FIG 2.:

$$\text{Contrast Ratio} = \frac{\text{Average Surface Luminance with all white pixels (P}_1, P_2, P_3, P_4, P_5)}{\text{Average Surface Luminance with all black pixels (P}_1, P_2, P_3, P_4, P_5)}$$

Note 2. Surface luminance is the LCD surface from the surface with all pixels displaying white. For more information see FIG 2.

$$L_v = \text{Average Surface Luminance with all white pixels (P}_1, P_2, P_3, P_4, P_5)$$

Note 3. The uniformity in surface luminance, δ WHITE is determined by measuring luminance at each test position 1 through 5, and then dividing the maximum luminance of 5 points luminance by minimum luminance of 5 points luminance. For more information see FIG 2.

$$\delta \text{ WHITE} = \frac{\text{Minimum Surface Luminance with all white pixels (P}_1, P_2, P_3, P_4, P_5)}{\text{Maximum Surface Luminance with all white pixels (P}_1, P_2, P_3, P_4, P_5)}$$

Note 4. Response time is the time required for the display to transition from White to black(Rise Time, Tr) and from black to white(Decay Time, Tf). For additional information see FIG 1. The test equipment is Autronic-Melchers's ConoScope. Series

Note 5. CIE (x, y) chromaticity, The x,y value is determined by measuring luminance at each test position 1 through 5, and then make average value

Note 6. Viewing angle is the angle at which the contrast ratio is greater than 2. For TFT module the contrast ratio is greater than 10. The angles are determined for the horizontal or x axis and the vertical or y axis with respect to the z axis which is normal to the LCD surface. For more information see FIG 3.

Note 7. For Viewing angle and response time testing, the testing data is base on Autronic-Melchers's ConoScope. Series Instruments. For contrast ratio, Surface Luminance, Luminance uniformity, CIE The test data is base on TOPCON's BM-5 photo detector.

Note 8. For TFT module, Gray scale reverse occurs in the direction of panel viewing angle.

FIG.1. The definition of Response Time

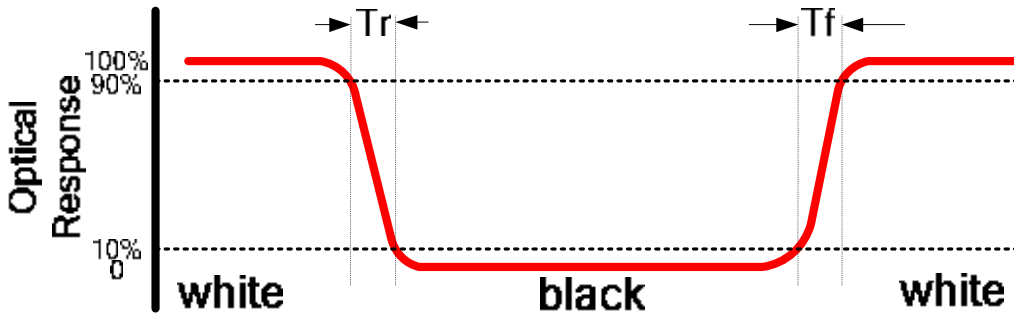

FIG.2. Measuring method for Contrast ratio, surface luminance, Luminance uniformity, CIE (x, y) chromaticity

A : 5 mm
 B : 5 mm
 H, V : Active Area
 Light spot size $\varnothing=5\text{mm}$, 500mm distance from the LCD surface to detector lens
 measurement instrument is TOPCON's luminance meter BM-5

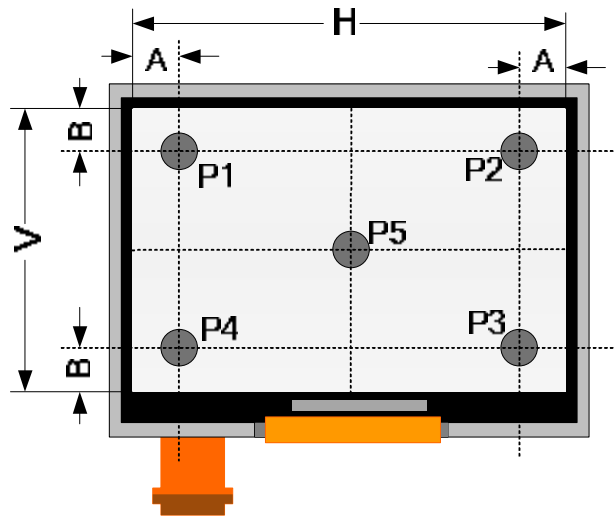
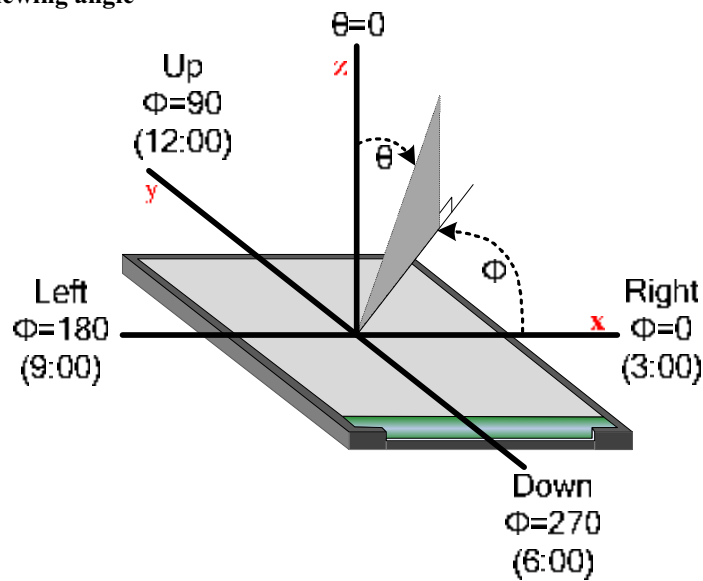

FIG.3. The definition of viewing angle



■ INTERFACE DESCRIPTION

Pin No.	Symbol	Description
1~2	VCI	Booster input voltage pin
3	VSS	Ground.
4	VDDIO	Voltage input pin for logic I/O
6	RESB	System reset pin. - An active low pulse at this pin will reset the IC, Connect to VDDIO in normal operation
7	DC/SDC	A register select signal. Low: select an index or status register, High: select a control register. DC : Parallel Interface SDC : Serial Interface
8	E/ \overline{RD}	6800-system : E (enable signal) 8080-system : RD (read strobe signal) Serial mode : Not used and should be connected to VDDIO or Vss
9	\overline{WR} (WR)	6800-system : RW (indicates read cycle when High, write cycle when Low) 8080-system : WR (write strobe signal)
10	\overline{CS} (SCS)	CS : Chip select pin for 6800/8080 Parallel Interface SCS : Chip Select pin for Serial Mode Interface
11	SCL	Serial clock input
12	SDO	Data output pin in serial interface
13	SDI	Data input pin in serial interface
14	WSYNC	Ram Write Synchronization output -Leave it OPEN when not used
15~32	DB17~DB0	Data bus.
33	VSS	Ground.
34	DOTCLK	Dot-clock signal and oscillator source.
35	HSYNC	Line Synchronization input
36	VSYNC	Frame/Ram Write Synchronization input
37	OE	Display enable pin from controller.



38	VSS	Ground.
39	PS0	Refer of Table1
40	PS1	
41	PS2	
42	PS3	
43	VSS	Ground.
44~47	NC	Not Connection
48	VSS	Ground.
49	LEDK	Cathode of LED backlight.
50	LEDA	Anode of LED backlight.

Table1

PS3	PS2	PS1	PS0	Interface Mode
0	0	0	0	16-bit 6800 parallel interface
0	0	0	1	8-bit 6800 parallel interface
0	0	1	0	16-bit 8080 parallel interface
0	0	1	1	8-bit 8080 parallel interface
0	1	0	0	9-bit generic D[17:9] (262k colour) + 3-wire SPI If 65K color, D12 shorts to D17 internally
0	1	0	1	16-bit generic (262k colour)+ 3-wire SPI
0	1	1	0	18-bit generic (262k colour)+ 3-wire SPI
0	1	1	1	6-bit generic D[17:12] (262k colour) + 3-wire SPI
1	0	0	0	18-bits 6800 parallel interface
1	0	0	1	9-bits 6800 parallel interface
1	0	1	0	18-bit 8080 parallel interface
1	0	1	1	9-bit 8080 parallel interface
1	1	1	0	3-wire SPI
1	1	1	1	4-wire SPI

■ BLOCK DIAGRAM

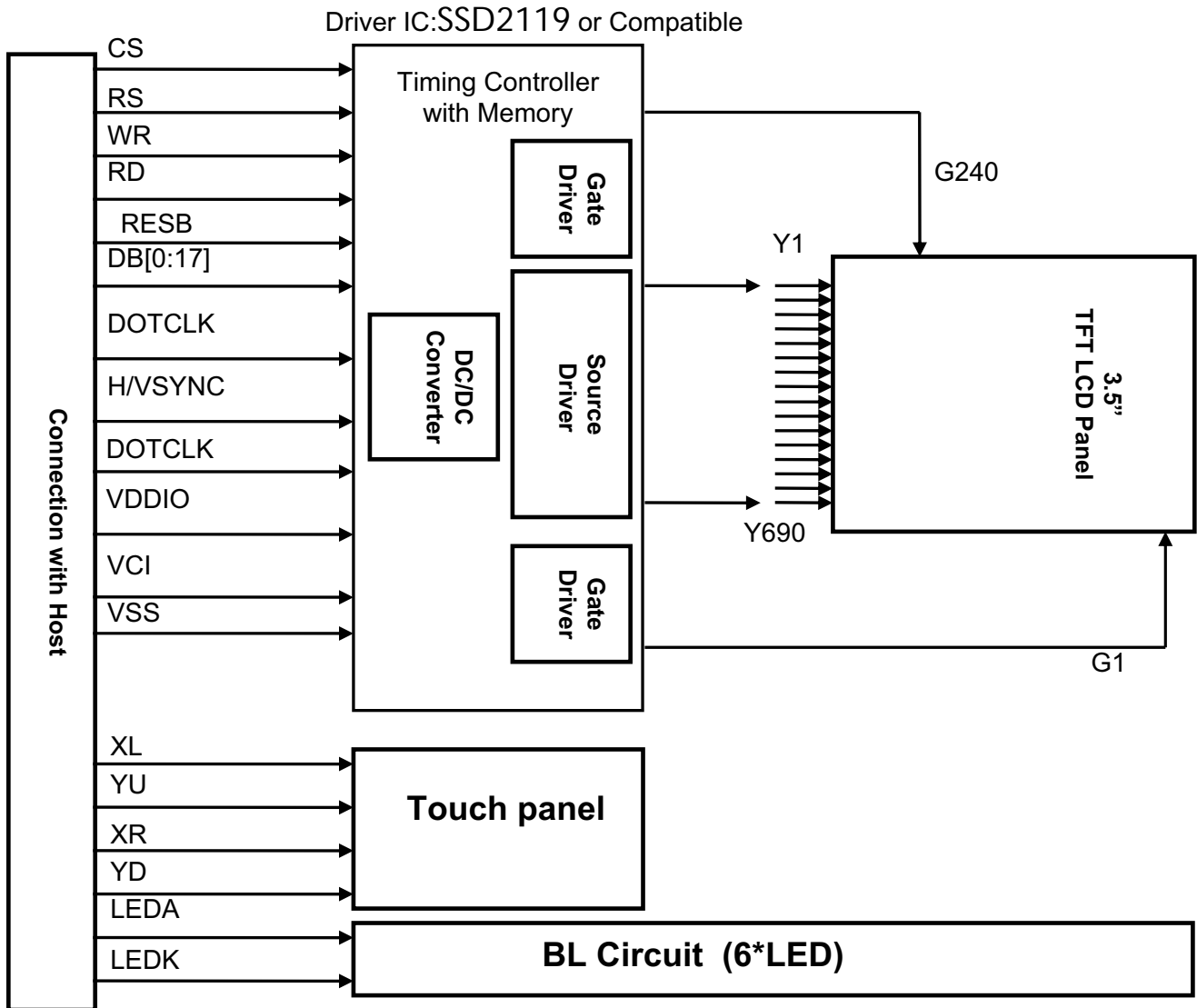

■ APPLICATION CIRCUIT

Please consult our technical department for detail information.

**■ RELIABILITY TEST**

No.	Test Item	Test Condition	Inspection after test
1	High Temperature Storage	$80 \pm 2^{\circ}\text{C}/240\text{hours}$	1. Functional test is OK. Missing Segment, short, unclear segment, non-display, display abnormally and liquid crystal leak are un-allowed. 2. No low temperature bubbles, end seal loose and fall, frame rainbow.
2	Low Temperature Storage	$-30 \pm 2^{\circ}\text{C}/240\text{hours}$	
3	High Temperature Operating	$70 \pm 2^{\circ}\text{C}/240\text{hours}$	
4	Low Temperature Operating	$-20 \pm 2^{\circ}\text{C}/240\text{hours}$	
5	Temperature Cycle	$-30 \pm 2^{\circ}\text{C} \sim 25 \sim 80 \pm 2^{\circ}\text{C} \times 10\text{cycles}$ (30min.) (5min.) (30min.)	
6	Damp Proof Test	$40^{\circ}\text{C} \pm 5^{\circ}\text{C} \times 90\%\text{RH}/240\text{hours}$	1. Function test is OK. 2. No glass crack, chipped glass, end seal loose and fall, epoxy frame crack 3. No structure loose and fall.
7	Vibration Test	Frequency: 10Hz~55Hz Amplitude: 1.0mm, Each direction on X,Y axe 0.5 hours, circle 2 hours	
8	Dropping test	Drop to the ground from 80cm height, one time, every side of carton.	

■ INSPECTION CRITERION

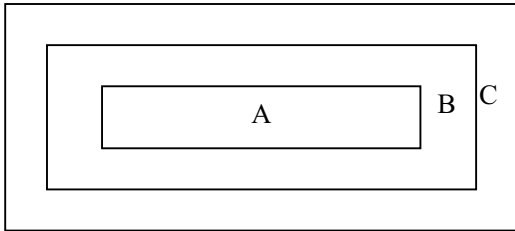
 <p>OUTGOING QUALITY STANDARD</p>	<p>PAGE 1 OF 4</p>
<p>TITLE:FUNCTIONAL TEST & INSPECTION CRITERIA</p>	<p>MDS Product</p>
<p>This specification is made to be used as the standard acceptance/rejection criteria for Color mobile phone LCM.</p> <p>1 Sample plan</p> <p>Sampling plan according to GB/T2828.1-2003/ISO 2859-1: 1999 and ANSI/ASQC Z1.4-1993, normal level 2 and based on:</p> <p>Major defect: AQL 0.65</p> <p>Minor defect: AQL 1.5</p> <p>2. Inspection condition</p> <p>Viewing distance for cosmetic inspection is about 30cm with bare eyes, and under an environment of 20~40W light intensity, all directions for inspecting the sample should be within 45°against perpendicular line.</p> <p>3. Definition of inspection zone in LCD.</p> <div data-bbox="523 1131 1040 1361" data-label="Diagram">  </div> <p>Zone A: character/Digit area</p> <p>Zone B: viewing area except Zone A (ZoneA+ZoneB=minimum Viewing area)</p> <p>Zone C: Outside viewing area (invisible area after assembly in customer's product)</p> <p>Fig.1 Inspection zones in an LCD.</p> <p>Note: As a general rule, visual defects in Zone C are permissible, when it is no trouble for quality and assembly of customer's product.</p>	



OUTGOING QUALITY STANDARD	PAGE 2 OF 4
TITLE:FUNCTIONAL TEST & INSPECTION CRITERIA	MDS Product

4. Inspection standards

4.1 Major Defect

Item No	Items to be inspected	Inspection Standard	Classification of defects
4.1.1	All functional defects	1) No display 2) Display abnormally 3) Missing vertical, horizontal segment 4) Short circuit 5) Back-light no lighting, flickering and abnormal lighting.	Major
4.1.2	Missing	Missing component	
4.1.3	Outline dimension	Overall outline dimension beyond the drawing is not allowed.	

4.2 Cosmetic Defect

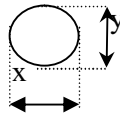
Item No	Items to be inspected	Inspection Standard	Classification of defects																										
4.2.1	Clear Spots	For dark/white spot, size Φ is defined as $\Phi = \frac{(x+y)}{2}$ <div style="display: inline-block; vertical-align: middle;">  </div>	Minor																										
	Black and white Spot defect Pinhole, Foreign Particle, Dirt under polarizer	1. <table border="1" style="width: 100%; border-collapse: collapse; text-align: center;"> <thead> <tr> <th rowspan="2">Size(mm) \ Zone</th> <th colspan="3">Acceptable Qty</th> </tr> <tr> <th>A</th> <th>B</th> <th>C</th> </tr> </thead> <tbody> <tr> <td>$\Phi \leq 0.10$</td> <td colspan="3">Ignore</td> </tr> <tr> <td>$0.10 < \Phi \leq 0.15$</td> <td colspan="3">2</td> </tr> <tr> <td>$0.15 < \Phi \leq 0.20$</td> <td colspan="3">1</td> </tr> <tr> <td>$\Phi > 0.20$</td> <td colspan="3">0</td> </tr> </tbody> </table>		Size(mm) \ Zone	Acceptable Qty			A	B	C	$\Phi \leq 0.10$	Ignore			$0.10 < \Phi \leq 0.15$	2			$0.15 < \Phi \leq 0.20$	1			$\Phi > 0.20$	0					
Size(mm) \ Zone	Acceptable Qty																												
	A	B	C																										
$\Phi \leq 0.10$	Ignore																												
$0.10 < \Phi \leq 0.15$	2																												
$0.15 < \Phi \leq 0.20$	1																												
$\Phi > 0.20$	0																												
	Dim Spots	2.	Minor																										
	Circle shaped and dim edged defects	<table border="1" style="width: 100%; border-collapse: collapse; text-align: center;"> <thead> <tr> <th rowspan="2">2. Zone \ Size(mm)</th> <th colspan="3">Acceptable Qty</th> </tr> <tr> <th>A</th> <th>B</th> <th>C</th> </tr> </thead> <tbody> <tr> <td>$\Phi \leq 0.2$</td> <td colspan="3">Ignore</td> </tr> <tr> <td>$0.20 < \Phi \leq 0.40$</td> <td colspan="3">3</td> </tr> <tr> <td>$0.40 < \Phi \leq 0.60$</td> <td colspan="3">2</td> </tr> <tr> <td>$0.60 < \Phi \leq 0.80$</td> <td colspan="3">1</td> </tr> <tr> <td>$0.80 < \Phi$</td> <td colspan="3">0</td> </tr> </tbody> </table>		2. Zone \ Size(mm)	Acceptable Qty			A	B	C	$\Phi \leq 0.2$	Ignore			$0.20 < \Phi \leq 0.40$	3			$0.40 < \Phi \leq 0.60$	2			$0.60 < \Phi \leq 0.80$	1			$0.80 < \Phi$	0	
2. Zone \ Size(mm)	Acceptable Qty																												
	A	B	C																										
$\Phi \leq 0.2$	Ignore																												
$0.20 < \Phi \leq 0.40$	3																												
$0.40 < \Phi \leq 0.60$	2																												
$0.60 < \Phi \leq 0.80$	1																												
$0.80 < \Phi$	0																												





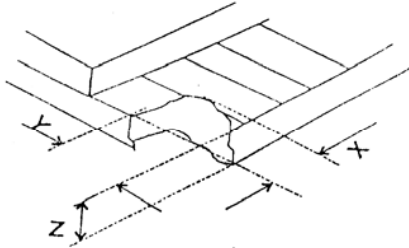
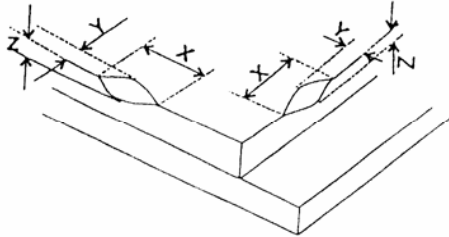
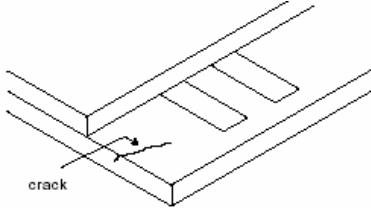

OUTGOING QUALITY STANDARD		PAGE 3 OF 4					
TITLE: FUNCTIONAL TEST & INSPECTION CRITERIA		MDS Product					
4.2. Cosmetic Defect							
Item No	Items to be inspected	Inspection Standard			Classification of defects		
4.2.2	Line defect Black line, White line, Foreign material under polarizer,	Size(mm)		Acceptable Qty		Minor	
		L(Length)	W(Width)	Zone			
				A	B		C
		Ignore	$W \leq 0.02$	Ignore			Ignore
		$L \leq 3.0$	$0.02 < W \leq 0.03$	2			
		$L \leq 2.0$	$0.03 < W \leq 0.05$	1			
	$0.05 < W$	Define as spot defect					
4.2.3	Polarizer scratch	If the Polarizer scratch can be seen after mobile phone cover assembling or in the operating condition, judge by the line defect of 4.2.2. If the Polarizer scratch can be seen only in non-operating condition or some special angle, judge by the following.			Minor		
		Size(mm)		Acceptable Qty			
		L(Length)	W(Width)	Zone			
				A		B	C
		Ignore	$W \leq 0.03$	Ignore		Ignore	
		$5.0 < L \leq 10.0$	$0.03 < W \leq 0.05$	2			
$L \leq 5.0$	$0.05 < W \leq 0.08$	1					
	$0.08 < W$	0					
4.2.4	Polarize Air bubble	Air bubbles between glass & polarizer			Minor		
		2. Zone Size(mm)	Acceptable Qty				
			A	B		C	
		$\Phi \leq 0.2$	Ignore			Ignore	
		$0.20 < \Phi \leq 0.30$	2				
$0.30 < \Phi \leq 0.50$	1						
$0.50 < \Phi$	0						

	OUTGOING QUALITY STANDARD	PAGE 4 OF 4
TITLE:FUNCTIONAL TEST & INSPECTION CRITERIA		MDS Product

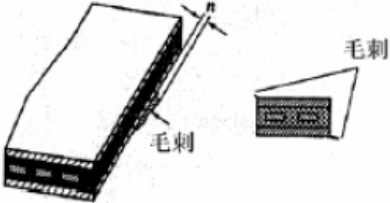
4.3. Cosmetic Defect

Item No	Items to be inspected	Inspection Standard	Classification of defects						
4.3.5	Glass defect	(i) Chips on corner  <table border="1" style="margin-left: auto; margin-right: auto;"> <tr> <td style="text-align: center;">X</td> <td style="text-align: center;">Y</td> <td style="text-align: center;">Z</td> </tr> <tr> <td style="text-align: center;">≤2.0</td> <td style="text-align: center;">≤S</td> <td style="text-align: center;">Disregard</td> </tr> </table> Notes: S=contact pad length Chips on the corner of terminal shall not be allowed to extend into the ITO pad or expose perimeter seal.	X	Y	Z	≤2.0	≤S	Disregard	Minor
		X	Y	Z					
		≤2.0	≤S	Disregard					
(ii) Usual surface cracks  <table border="1" style="margin-left: auto; margin-right: auto;"> <tr> <td style="text-align: center;">X</td> <td style="text-align: center;">Y</td> <td style="text-align: center;">Z</td> </tr> <tr> <td style="text-align: center;">≤3.0</td> <td style="text-align: center;"><Inner border line of the seal</td> <td style="text-align: center;">Disregard</td> </tr> </table>	X	Y	Z	≤3.0	<Inner border line of the seal	Disregard	Minor		
X	Y	Z							
≤3.0	<Inner border line of the seal	Disregard							
(iii) Crack Cracks tend to break are not allowed. 	Major								
4.3.6	Parts alignment	1) Not allow IC and FPC/heat-seal lead width is more than 50% beyond lead pattern. 2) Not allow chip or solder component is off center more than 50% of the pad outline.	Minor						
4.3.7	SMT	According to the <Acceptability of electronic assemblies> IPC-A-610C class 2 standard. Component missing or function defect are Major defect, the others are Minor defect.							

<p>OUTGOING QUALITY STANDARD</p>	<p>PAGE 7 OF 7</p>	
<p>TITLE: FUNCTIONAL TEST & INSPECTION CRITERIA</p>		
<p>4.3.8 TP Defect</p>	<p>1、 Pattern font: Pattern fonts are clear and symmetrical, pattern fonts filter lightly are allowed; The fort line is not allow to thinner or thicker than 1/3of normal size, and swing is not more than 0.1mm. the line is smooth and not broken.</p>  <p>图案字体 Pattern font</p> <p>2、 The wing forward in the side of Visual Area: The length of wing forward inside of the Visual Area: $n \leq 0.2\text{mm}$; Not excess 3 point, and the distance $D \geq 20\text{mm}$.</p>  <p>3、 Film impression:With operation, must be invisibility.</p> <p>4、 Touch panel knob: if writing function normally,it could be allowed.</p>  <p>TP鼓 TP knob</p> <p>5、 Newton ring Without operation, the color circle of Regularity or Non-regularity from the normal or slope angle of view.</p> <p>1、 Regularity: The area of the newton ring is less than 1/3 area of the touch panel; and no character affected and line distorted after touch panel lightening. It's ok.</p> <p>2、 Non-regularity : The area of the Newton ring is less than the 1/2 area of touch panel with lightening. And no character affected and line</p>  <p>规律形</p>  <p>非规律形</p>	<p>Minor</p>



■ PRECAUTIONS FOR USING LCD MODULES

1 Handling Precautions

- 1.1 The display panel is made of glass and polarizer. As glass is fragile. It tends to become or chipped during handling especially on the edges. Please avoid dropping or jarring. Do not subject it to a mechanical shock by dropping it or impact.
- 1.2 If the display panel is damaged and the liquid crystal substance leaks out, be sure not to get any in your mouth. If the substance contacts your skin or clothes, wash it off using soap and water.
- 1.3 Do not apply excessive force to the display surface or the adjoining areas since this may cause the color tone to vary. Do not touch the display with bare hands. This will stain the display area and degraded insulation between terminals (some cosmetics are determined to the polarizer).
- 1.4 The polarizer covering the display surface of the LCD module is soft and easily scratched. Handle this polarizer carefully. Do not touch, push or rub the exposed polarizers with anything harder than an HB pencil lead (glass, tweezers, etc.). Do not put or attach anything on the display area to avoid leaving marks on it. Condensation on the surface and contact with terminals due to cold will damage, stain or dirty the polarizer. After products are tested at low temperature they must be warmed up in a container before coming in to contact with room temperature air.
- 1.5 If the display surface becomes contaminated, breathe on the surface and gently wipe it with a soft dry cloth. If it is heavily contaminated, moisten cloth with one of the following solvents
 - Isopropyl alcohol
 - Ethyl alcoholDo not scrub hard to avoid damaging the display surface.
- 1.6 Solvents other than those above-mentioned may damage the polarizer. Especially, do not use the following.
 - Water
 - Ketone
 - Aromatic solventsWipe off saliva or water drops immediately, contact with water over a long period of time may cause deformation or color fading. Avoid contact with oil and fats.
- 1.7 Exercise care to minimize corrosion of the electrode. Corrosion of the electrodes is accelerated by water droplets, moisture condensation or a current flow in a high-humidity environment.
- 1.8 Install the LCD Module by using the mounting holes. When mounting the LCD module make sure it is free of twisting, warping and distortion. In particular, do not forcibly pull or bend the I/O cable or the backlight cable.
- 1.9 Do not attempt to disassemble or process the LCD module.
- 1.10 NC terminal should be open. Do not connect anything.
- 1.11 If the logic circuit power is off, do not apply the input signals.
- 1.12 Electro-Static Discharge Control, Since this module uses a CMOS LSI, the same careful attention should be paid to electrostatic discharge as for an ordinary CMOS IC. To prevent destruction of the elements by static electricity, be careful to maintain an optimum work environment.
 - Before removing LCM from its packing case or incorporating it into a set, be sure the module and your body have the same electric potential. Be sure to ground the body when handling the LCD modules.
 - Tools required for assembling, such as soldering irons, must be properly grounded. Make certain the AC power source for the soldering iron does not leak. When using an electric screwdriver to attach LCM, the screwdriver should be of ground potentiality to minimize as much as possible any transmission of electromagnetic waves produced sparks coming from the commutator of the motor.
 - To reduce the amount of static electricity generated, do not conduct assembling



and other work under dry conditions. To reduce the generation of static electricity be careful that the air in the work is not too dry. A relative humidity of 50%-60% is recommended. As far as possible make the electric potential of your work clothes and that of the work bench the ground potential.

- The LCD module is coated with a film to protect the display surface. Exercise care when peeling off this protective film since static electricity may be generated.

1.13 Since LCM has been assembled and adjusted with a high degree of precision, avoid applying excessive shocks to the module or making any alterations or modifications to it.

- Do not alter, modify or change the shape of the tab on the metal frame.
- Do not make extra holes on the printed circuit board, modify its shape or change the positions of components to be attached.
- Do not damage or modify the pattern writing on the printed circuit board.
- Absolutely do not modify the zebra rubber strip (conductive rubber) or heat seal connector.
- Except for soldering the interface, do not make any alterations or modifications with a soldering iron.
- Do not drop, bend or twist the LCM.

2 Handling precaution for LCM

2.1 LCM is easy to be damaged. Please note below and be careful for handling.

2.2 Correct handling:



As above picture, please handle with anti-static gloves around LCM edges.

2.3 Incorrect handling:



Please don't touch IC directly.

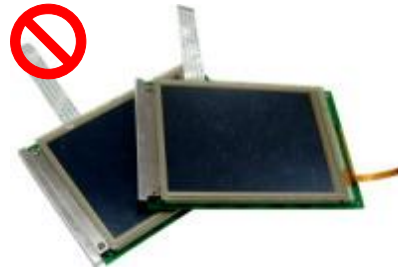

Please don't stack LCM.



Please don't hold the surface of panel.

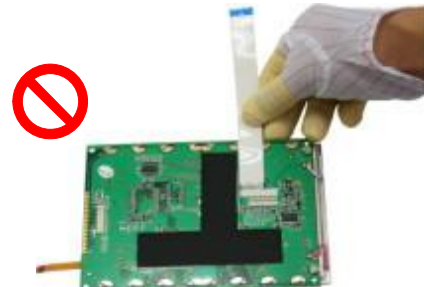

Please don't stretch interface of output, such as FPC cable.

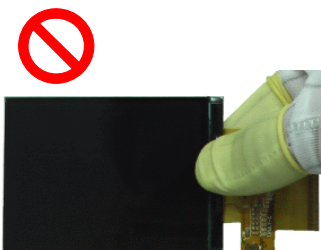

Please don't hold the surface of IC.

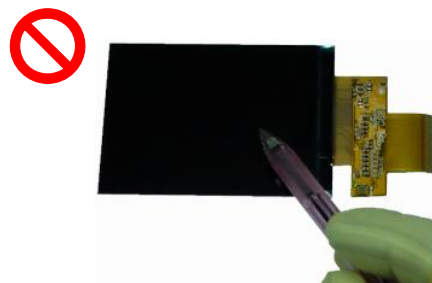

Please don't operate with sharp stick such as pens.

3 Storage Precautions

- 3.1 When storing the LCD modules, the following precaution are necessary.
- 3.1.1 Store them in a sealed polyethylene bag. If properly sealed, there is no need for the desiccant.
 - 3.1.2 Store them in a dark place. Do not expose to sunlight or fluorescent light, keep the temperature between 0°C and 35°C, and keep the relative humidity between 40%RH and 60%RH.
 - 3.1.3 The polarizer surface should not come in contact with any other objects (We advise you to store them in the anti-static electricity container in which they were shipped).
- 3.2 Others 其它
- 3.2.1 Liquid crystals solidify under low temperature (below the storage temperature range) leading to defective orientation or the generation of air bubbles (black or white). Air bubbles may also be generated if the module is subject to a low temperature.
 - 3.2.2 If the LCD modules have been operating for a long time showing the same display patterns, the display patterns may remain on the screen as ghost images and a slight contrast irregularity may also appear. A normal operating status can be regained by suspending use for some time. It should be noted that this phenomenon does not adversely affect performance reliability.
 - 3.2.3 To minimize the performance degradation of the LCD modules resulting from destruction caused by static electricity etc., exercise care to avoid holding the following sections when handling the modules.
 - 3.2.3.1 - Exposed area of the printed circuit board.
 - 3.2.3.2 -Terminal electrode sections.

4 USING LCD MODULES

4.1 Installing LCD Modules

The hole in the printed circuit board is used to fix LCM as shown in the picture below.

Attend to the following items when installing the LCM.

- 4.1.1 Cover the surface with a transparent protective plate to protect the polarizer and LC cell.

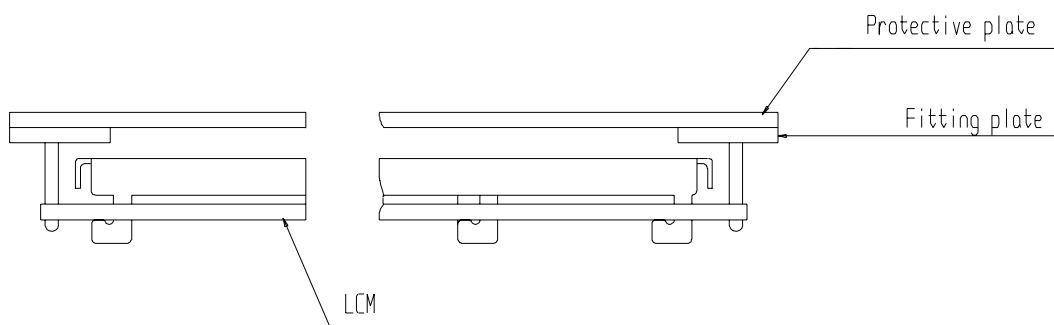

- 4.1.2 When assembling the LCM into other equipment, the spacer to the bit between the LCM and the fitting plate should have enough height to avoid causing stress to the module surface, refer to the individual specifications for measurements. The measurement tolerance should be ± 0.1 mm.

4.2 Precaution for assemble the module with BTB connector:

Please note the position of the male and female connector position, don't assemble or assemble like the method which the following picture shows

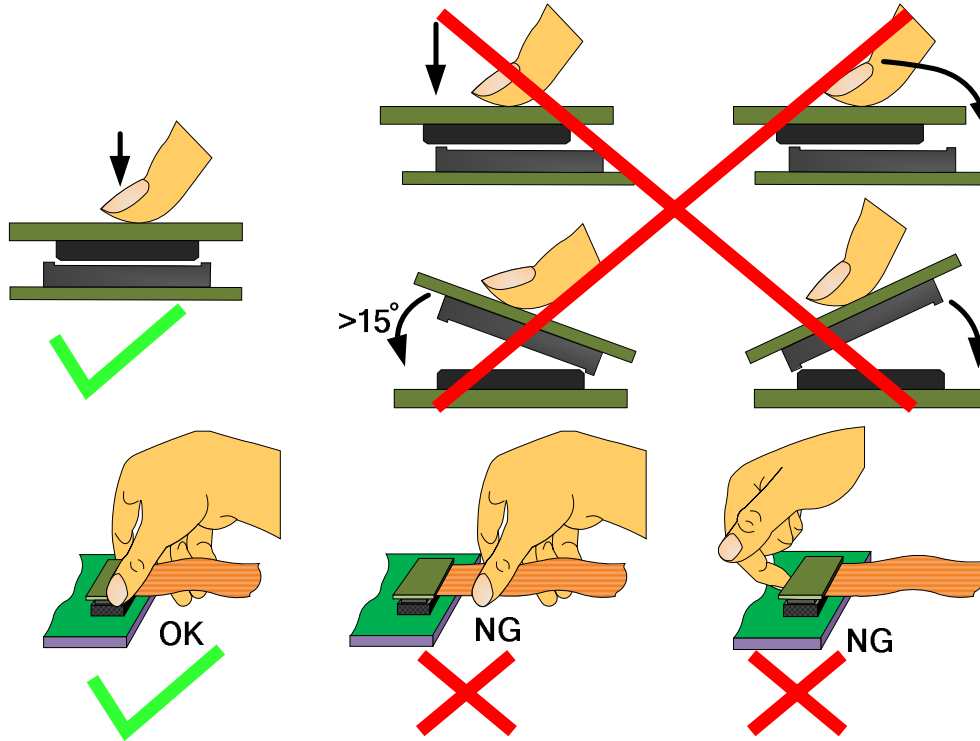

4.3 Precaution for soldering the LCM

	Manual soldering	Machine drag soldering	Machine press soldering
No RoHS Product	290°C ~350°C. Time : 3-5S.	330°C ~350°C. Speed : 15-17 mm/s.	300°C ~330°C. Time : 3-6S. Press: 0.8~1.2Mpa
RoHS Product	340°C ~370°C. Time : 3-5S.	350°C ~370°C. Speed : 15-17 mm/s.	330°C ~360°C. Time : 3-6S. Press: 0.8~1.2Mpa

- 4.3.1 If soldering flux is used, be sure to remove any remaining flux after finishing to soldering operation (This does not apply in the case of a non-halogen type of flux). It is recommended that you protect the LCD surface with a cover during soldering to prevent any damage due to flux spatters.
- 4.3.2 When soldering the electroluminescent panel and PC board, the panel and board should not be detached more than three times. This maximum number is determined by the temperature and time conditions mentioned above, though there may be some variance depending on the temperature of the soldering iron.
- 4.3.3 When remove the electroluminescent panel from the PC board, be sure the solder has completely melted, the soldered pad on the PC board could be damaged.

4.4 Precautions for Operation

- 4.4.1 Viewing angle varies with the change of liquid crystal driving voltage (VLCD). Adjust VLCD to show the best contrast.
- 4.4.2 It is an indispensable condition to drive LCD's within the specified voltage limit since the higher voltage then the limit cause the shorter LCD life. An electrochemical reaction due to direct current causes LCD's undesirable deterioration, so that the use of direct current drive should be avoided.
- 4.4.3 Response time will be extremely delayed at lower temperature than the operating temperature range and on the other hand at higher temperature LCD's show dark color in them. However those phenomena do not mean malfunction or out of order with LCD's, which will come back in the specified operating temperature.
- 4.4.4 If the display area is pushed hard during operation, the display will become abnormal. However, it will return to normal if it is turned off and then back on.
- 4.4.5 A slight dew depositing on terminals is a cause for electro-chemical reaction resulting in terminal open circuit. Usage under the maximum operating temperature, 50%RH or less is required.
- 4.4.6 Input logic voltage before apply analog high voltage such as LCD driving voltage when power on. Remove analog high voltage before logic voltage when power off the module. Input each signal after the positive/negative voltage becomes stable.
- 4.4.7 Please keep the temperature within the specified range for use and storage. Polarization degradation, bubble generation or polarizer peel-off may occur with high temperature and high humidity.

4.5 Safety

- 4.5.1 It is recommended to crush damaged or unnecessary LCDs into pieces and wash them off with solvents such as acetone and ethanol, which should later be burned.
- 4.5.2 If any liquid leaks out of a damaged glass cell and comes in contact with the hands, wash off thoroughly with soap and water.



4.6 Limited Warranty

Unless agreed between Multi-Inno and the customer, Multi-Inno will replace or repair any of its LCD modules which are found to be functionally defective when inspected in accordance with Multi-Inno LCD acceptance standards (copies available upon request) for a period of one year from date of production. Cosmetic/visual defects must be returned to Multi-Inno within 90 days of shipment. Confirmation of such date shall be based on data code on product. The warranty liability of Multi-Inno limited to repair and/or replace on the terms set forth above. Multi-Inno will not be responsible for any subsequent or consequential events.

4.7 Return LCM under warranty

4.7.1 No warranty can be granted if the precautions stated above have been disregarded. The typical examples of violations are :

4.7.1.1 - Broken LCD glass.

4.7.1.2 - PCB eyelet is damaged or modified.

4.7.1.3 -PCB conductors damaged.

4.7.1.4 - Circuit modified in any way, including addition of components.

4.7.1.5 - PCB tampered with by grinding, engraving or painting varnish.

4.7.1.6 - Soldering to or modifying the bezel in any manner.

4.7.2 Module repairs will be invoiced to the customer upon mutual agreement. Modules must be returned with sufficient description of the failures or defects. Any connectors or cable installed by the customer must be removed completely without damaging the PCB eyelet, conductors and terminals.

■ PACKING SPECIFICATION

Please consult our technical department for detail information.

■ PRIOR CONSULT MATTER

- 1 For Multi-Inno standard products, we keep the right to change material, process ... for improving the product property without prior notice to our customer.
- 2 For OEM products, if any changes are needed which may affect the product property, we will consult with our customer in advance.
- 3 If you have special requirement about reliability condition, please let us know before you start the test on our samples.