



MULTI-INNO TECHNOLOGY CO., LTD.

www.multi-inno.com

LCD MODULE SPECIFICATION

Model : MI0300GT-1

For Customer's Acceptance:

Customer	
Approved	
Comment	

Revision	1.2
Engineering	
Date	2013-05-08
Our Reference	



CONTENTS

- GENERAL INFORMATION
- EXTERNAL DIMENSIONS
- ABSOLUTE MAXIMUM RATINGS
- ELECTRICAL CHARACTERISTICS
- BACKLIGHT CHARACTERISTICS
- ELECTRO-OPTICAL CHARACTERISTICS
- INTERFACE DESCRIPTION
- REFERENCE APPLICATION NOTES
- RELIABILITY TEST
- INSPECTION CRITERION
- PRECAUTIONS FOR USING LCD MODULES
- PRIOR CONSULT MATTER

**■ GENERAL INFORMATION**

Item	Contents	Unit
LCD type	TFT ECB Transflective	/
Size	3.0	Inch
Viewing direction	6:00	O' Clock
Gray scale inversion direction	12:00	O' Clock
LCM (W × H × D)	47.28×76.40×2.40	mm ³
Active area (W×H)	38.88×64.80	mm ²
Pixel pitch (W×H)	0.162×0.162	mm ²
Number of dots	240 (RGB) × 400	/
Driver IC	HX8352B	/
Backlight type	4 LEDs	/
Interface type	RGB+3SPI/CPU	/
Color depth	262K	/
Pixel configuration	R.G.B vertical stripe	/
Surface treatment(Up polarizer)	Clear type(3H)	/
Input voltage	2.8	V
With/Without TSP	Without TSP	/
Weight	18.25	g

Note 1:Viewing direction for best image quality is different from TFT definition, there is a 180 degree shift.

Note 2 : RoHS compliant;

Note 3: LCM weight tolerance: ± 5% .

EXTERNAL DIMENSIONS

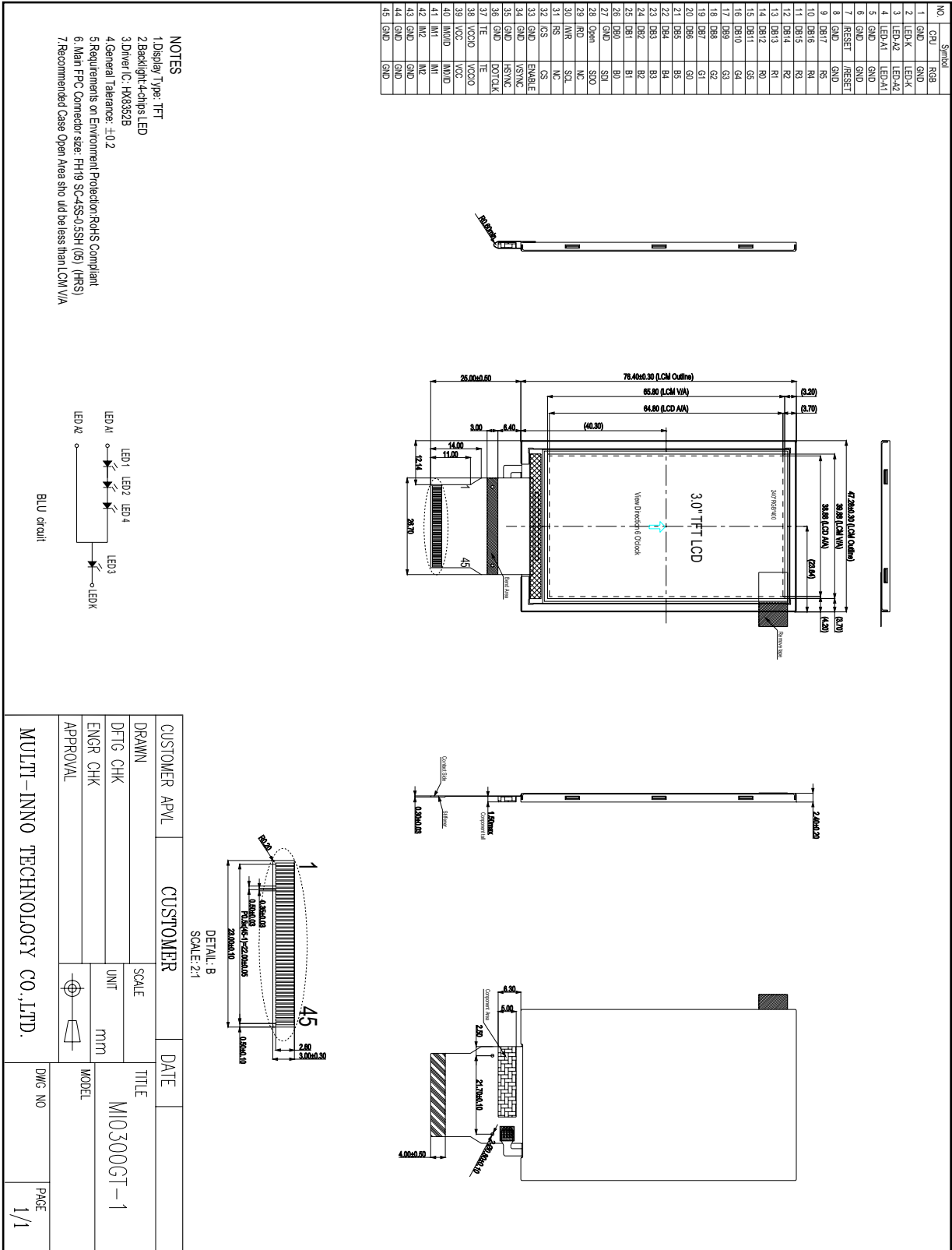

■ ABSOLUTE MAXIMUM RATINGS

Parameter	Symbol	Min	Max	Unit
Supply voltage	VCC	-0.3	4.6	V
Supply voltage	VCCIO	-0.3	4.6	V
Input voltage	VIN	-0.3	VCC+0.3	V
Back light forward current	I _{LED}	-	25	mA
Operating temperature	T _{OP}	-20	70	°C
Storage temperature	T _{ST}	-30	80	°C
Humidity	RH	-	90%(Max60°C)	RH

Note : VIN:D[17: 0], CS, RD, WR, RS/SCL,SDI, VSYNC, HSYNC, DOTCLK,ENABLE, BS[2:0]

■ ELECTRICAL CHARACTERISTICS

DC CHARACTERISTICS

Parameter	Symbol	Min	Typ	Max	Unit
Supply voltage	VCC	2.5	2.8	3.3	V
Supply voltage	IOVCC	1.65	2.8	3.3	V
Input voltage ' H ' level	V _{IH}	0.8IOVCC	-	IOVCC	V
Input voltage ' L ' level	V _{IL}	-0.3	-	0.2IOVCC	V
Output voltage ' H ' level	V _{OH}	0.7IOVCC	-	IOVCC	V
Output voltage ' L ' level	V _{OL}	-0.3	-	0.3IOVCC	V
(Panel+LSI) Power consumption	Black mode (60Hz)	-	TBD	-	mW
	8 color mode	-	TBD	-	mW
	Standby mode	-	TBD	-	mW

■ BACKLIGHT CHARACTERISTICS

Item	Symbol	Min.	Typ.	Max.	Unit	Condition
Forward voltage	V _f	-	12.8	-	V	If= 20mA
Backlight power consumption	W _{BL}	-	256	-	mW	
Number of LED	-	4			Piece	-
LED life time	-	20,000	-	-	Hrs	-

Note 1 : The LED driving condition is defined for each LED module.

Note 2: Backlight unit driving must depend on Forward Current setting.

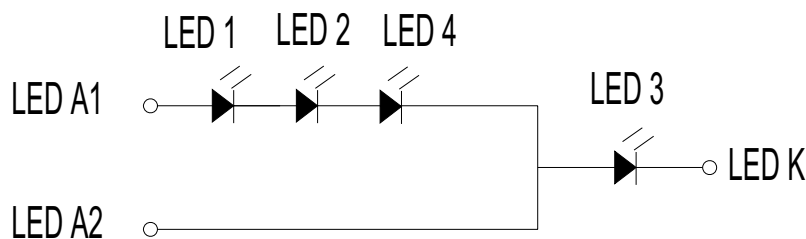

LED connection of backlight



■ELECTRO-OPTICAL CHARACTERISTICS

Driving the backlight condition

Item	Symbol	Condition	Min	Typ	Max	Unit	Remark	Note
Response time	Tr+Tf	$\theta=0^\circ$ $\varnothing=0^\circ$ $T_a=25^\circ\text{C}$	-	70	-	ms	FIG 1.	4
Contrast ratio	Cr		80	100	-	---	FIG 2.	1
Luminance uniformity	δ WHITE		-	-	-	%	FIG 2.	3
Surface Luminance	Lv		110	130	-	cd/m ²	FIG 2.	2
Viewing angle range	θ	$\varnothing = 90^\circ$	-	55	60	deg	FIG 3.	6
		$\varnothing = 270^\circ$	-	40	45	deg	FIG 3.	
		$\varnothing = 0^\circ$	-	45	50	deg	FIG 3.	
		$\varnothing = 180^\circ$	-	40	45	deg	FIG 3.	
CIE (x, y) chromaticity	Red	x	-	-	-	FIG 2.	5	
		y	-	-	-			
	Green	x	-	-	-			
		y	-	-	-			
	Blue	x	-	-	-			
		y	-	-	-			
	White	x	-	0.30	-			
		y	-	0.33	-			

Not driving the backlight condition

Item	Symbol	Condition	Min	Typ	Max	Unit	Remark	Note
Response time	Tr+Tf	$\theta=0^\circ$ $\varnothing=0^\circ$ $T_a=25^\circ\text{C}$	-	50	-	ms	FIG 1.	4
Contrast ratio	Cr		-	8	-	---	FIG 2.	1
Luminance uniformity	δ WHITE		-	-	-	%	FIG 2.	3
Surface Luminance	Lv		110	130	-	cd/m ²	FIG 2.	2
Viewing angle range	θ	$\varnothing = 90^\circ$	-	60	-	deg	FIG 3.	6
		$\varnothing = 270^\circ$	-	60	-	deg	FIG 3.	
		$\varnothing = 0^\circ$	-	60	-	deg	FIG 3.	
		$\varnothing = 180^\circ$	-	55	-	deg	FIG 3.	
CIE (x, y) chromaticity	Red	x	-	-	-	FIG 2.	5	
		y	-	-	-			
	Green	x	-	-	-			
		y	-	-	-			
	Blue	x	-	-	-			
		y	-	-	-			
	White	x	-	0.32	-			
		y	-	0.34	-			
Reflection ratio			6.85%					



Note 1. Contrast Ratio(CR) is defined mathematically as For more information see FIG 2.

$$\text{Contrast Ratio} = \frac{\text{Average Surface Luminance with all white pixels (P1, P2, P3, P4, P5)}}{\text{Average Surface Luminance with all black pixels (P1, P2, P3, P4, P5)}}$$

Note 2. Surface luminance is the LCD surface from the surface with all pixels displaying white. For more information see FIG 2.

$$L_v = \text{Average Surface Luminance with all white pixels (P1, P2, P3, P4, P5)}$$

Note 3. The uniformity in surface luminance, δ WHITE is determined by measuring luminance at each test position 1 through 5, and then dividing the maximum luminance of 5 points luminance by minimum luminance of 5 points luminance. For more information see FIG 2.

$$\delta \text{ WHITE} = \frac{\text{Minimum Surface Luminance with all white pixels (P1, P2, P3, P4, P5)}}{\text{Maximum Surface Luminance with all white pixels (P1, P2, P3, P4, P5)}}$$

Note 4. Response time is the time required for the display to transition from White to black(Rise Time, Tr) and from black to white(Decay Time, Tf). For additional information see FIG 1. The test equipment is Autronic-Melchers's ConoScope. Series.

Note 5. CIE (x, y) chromaticity, The x, y value is determined by measuring luminance at each test position 1 through 5, and then make average value.

Note 6. Viewing angle is the angle at which the contrast ratio is greater than 2. For TFT module the contrast ratio is greater than 10. The angles are determined for the horizontal or x axis and the vertical or y axis with respect to the z axis which is normal to the LCD surface. For more information see FIG 3.

Note 7. For viewing angle and response time testing, the testing data is base on Autronic-Melchers's ConoScope. Series Instruments For contrast ratio, Surface Luminance, Luminance uniformity, CIE The test data is base on TOPCON's BM-5 photo detector.

FIG. 1 The definition of Response Time

The response time is defined as the following figure and shall be measured by switching the input signal for “black” and “white”.

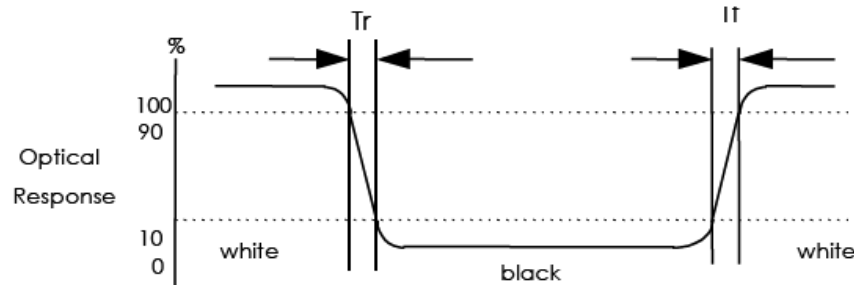
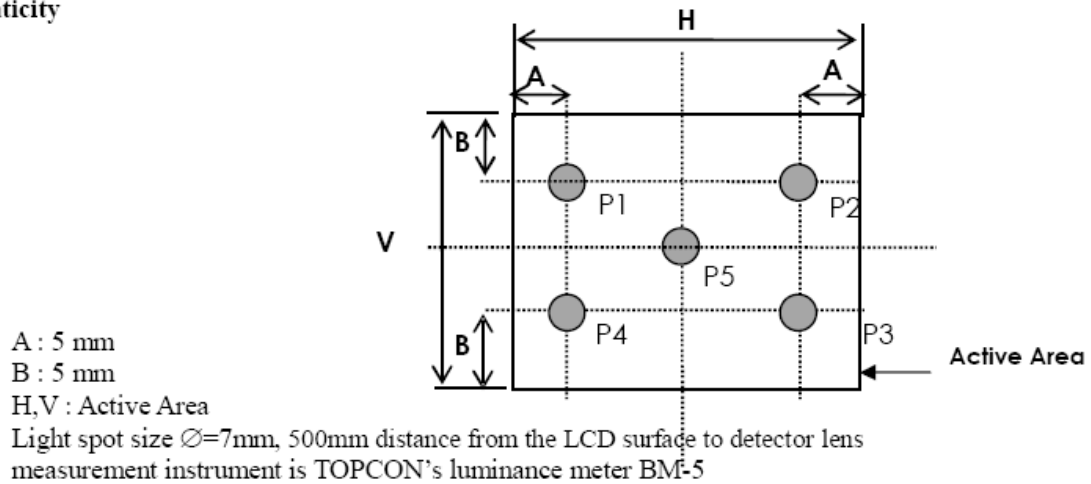
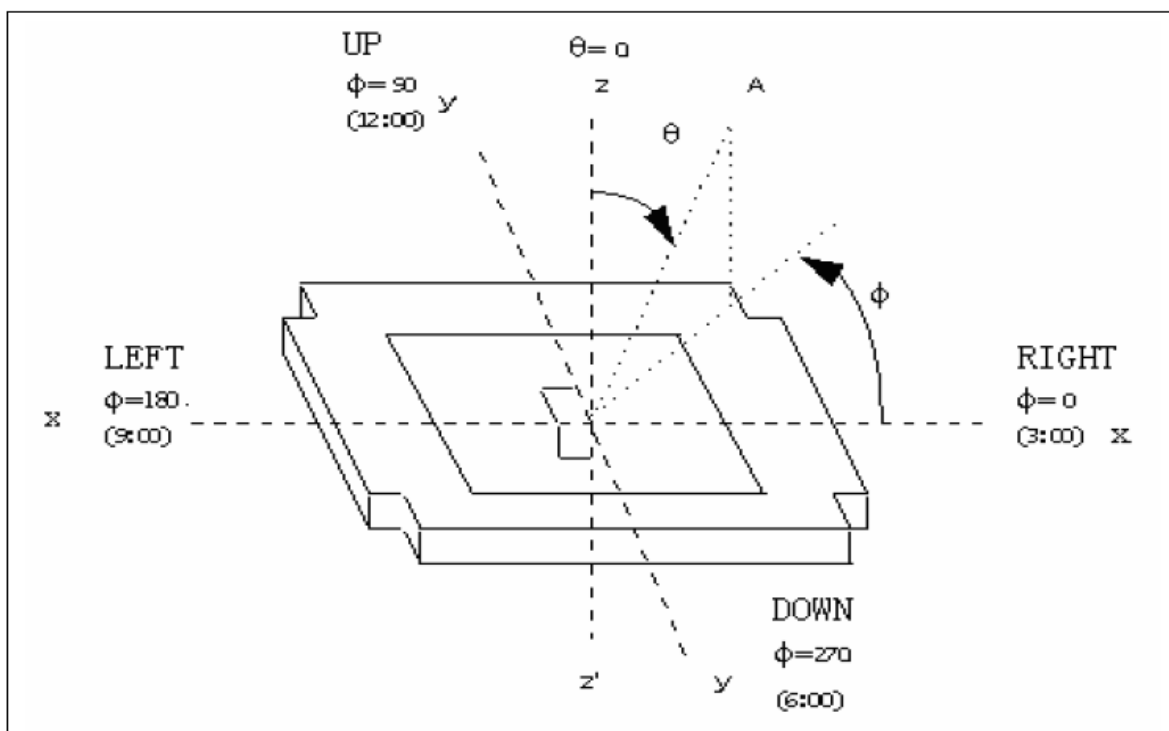
FIG. 2 Measuring method for Contrast ratio, surface luminance, Luminance uniformity , CIE (x, y) chromaticity

FIG. 3 The definition of viewing angle

■ INTERFACE DESCRIPTION

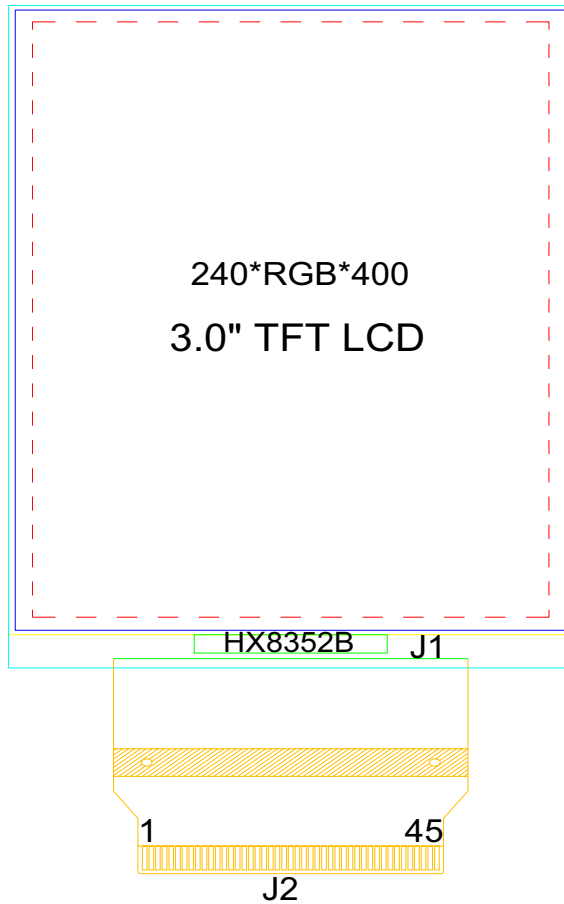
1. BlockDiagram





2 Input/Output Terminals

Pin	Symbol (CPU)	Symbol (RGB)	I/O	Description	Remark
1	GND	GND		Ground	
2	LED-K	LED-K		Power supply for LED(Low voltage)	
3	LED-A2	LED-A2		Power supply for LED(High voltage2)	
4	LED-A1	LED-A1		Power supply for LED(High voltage1)	
5	GND	GND		Ground	
6	GND	GND		Ground	
7	/RESET	/RESET	I	RESET serial(Low active)	
8	GND	GND		Ground	
9	DB17	R5	I/O	CPU:Data bus serial(MSB) RGB:RED data signal(MSB)	
10	DB16	R4	I/O	CPU:Data bus serial RGB:RED data signal	
11	DB15	R3	I/O	CPU:Data bus serial RGB:RED data signal	
12	DB14	R2	I/O	CPU:Data bus serial RGB:RED data signal	
13	DB13	R1	I/O	CPU:Data bus serial RGB:RED data signal	
14	DB12	R0	I/O	CPU:Data bus serial RGB:RED data signal(LSB)	
15	DB11	G5	I/O	CPU:Data bus serial RGB:GREEN data signal(MSB)	
16	DB10	G4	I/O	CPU:Data bus serial RGB:GREEN data signal	
17	DB9	G3	I/O	CPU:Data bus serial RGB:GREEN data signal	
18	DB8	G2	I/O	CPU:Data bus serial RGB:GREEN data signal	
19	DB7	G1	I/O	CPU:Data bus serial RGB:GREEN data signal	
20	DB6	G0	I/O	CPU:Data bus serial RGB:GREEN data signal(LSB)	
21	DB5	B5	I/O	CPU:Data bus serial RGB:BLUE data signal(MSB)	
22	DB4	B4	I/O	CPU:Data bus serial RGB:BLUE data signal	
23	DB3	B3	I/O	CPU:Data bus serial RGB:BLUE data signal	
24	DB2	B2	I/O	CPU:Data bus serial RGB:BLUE data signal	
25	DB1	B1	I/O	CPU:Data bus serial RGB:BLUE data signal	
26	DB0	B0	I/O	CPU:Data bus serial RGB:BLUE data signal(LSB)	



27	GND	SDI	I	CPU: Ground RGB: Serial data input pin	
28	OPEN	SDO	O	CPU: not use. leave open or to GND/VCCIO RGB: Serial data output pin	
29	/RD	NC	I	CPU: read signal and read data. RGB: NO connect	
30	/WR	NC	I	CPU: write signal and write data. RGB: NO connect	
31	RS	SCL	I	CPU: Data / Command Selection pin. RGB: Serial Clock signal	
32	/CS	CS	I	Chip select signal.	
33	GND	ENABLE	I	CPU: Ground RGB: A data ENABLE signal	
34	GND	VSYNC	I	CPU: Ground RGB: Frame synchronizing signal	
35	GND	HSYNC	I	CPU: Ground RGB: Frame synchronizing signal	
36	GND	DOTCLK	I	CPU: Ground RGB: Pixel clock signal	
37	TE	TE	O	CPU: Tearing effect output. RGB: Not used, please open this pin.	
38	VCCIO	VCCIO	P	I/O Pad and Digital power supply	
39	VCC	VCC	P	Analog power supply	
40	IM0/1D	IM0/1D	I	System interface select.	Note2
41	IM1	IM1	I	System interface select.	Note2
42	IM2	IM2	I	System interface select.	Note2
43	GND	GND		Ground	
44	GND	GND		Ground	
45	GND	GND		Ground	

Note1: P: Power/GND; I: input pin; O: output

Note2: System interface select

IM3	IM2	IM0	Interface
0	0	0	8080 MCU 18-bits Parallel II
0	1	0	8080 MCU 16-bits Parallel II
0	0	1	8080 MCU 9-bits Parallel II
0	1	1	8080 MCU 8-bits Parallel II
1	0	ID	3-wire Serial interface
1	1	0	4-wire Serial interface(1)
1	1	1	SPI(2),HSIM Interface

■ APPLICATION NOTES

1 AC ELECTRICAL CHARACTERISTICS

1.1 CPU interface mode

1.1.1 CPU Interface Characteristics

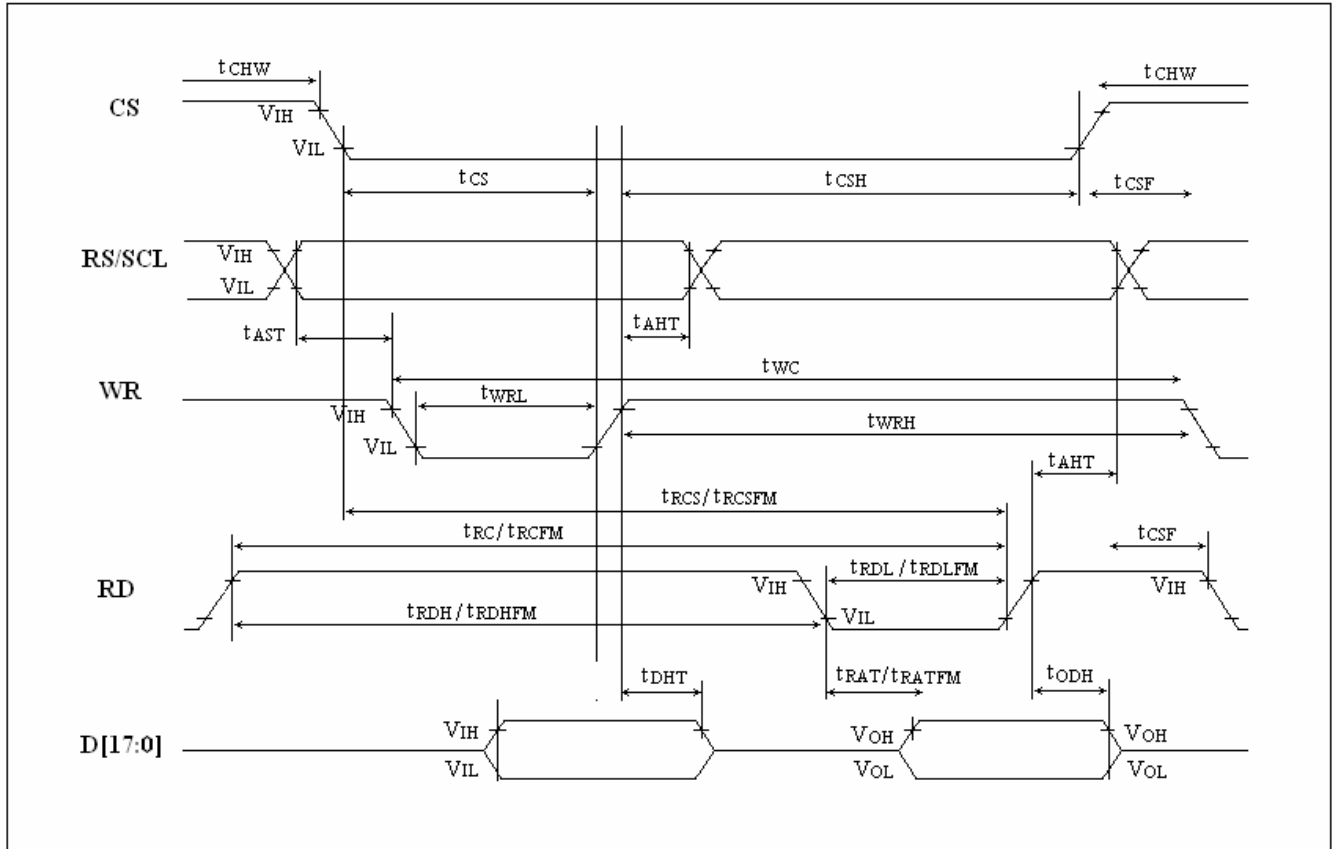

CPU Interface Characteristics



1.1.2 CPU Interface Timing Parameters

Normal Write Mode (IOVCC=1.65~3.3V, VCC=2.3~3.3V)

Signal	Symbol	Parameter	Spec.			Description
			Min.	Max.	Unit	
RS/SCL	t_{AST}	Address setup time	10	-	ns	-
	t_{AHT}	Address hold time(Write/Read)	10	-		
CS	t_{CHW}	Chip select "H" pulse width	0	-	ns	-
	t_{CS}	Chip select setup time (Write)	35	-		
	t_{RCS}	Chip select setup time (Read ID)	100	-		
	t_{RCSFM}	Chip select setup time (Read FM)	100	-		
	t_{CSF}	Chip select wait time(Write/Read)	10	-		
	t_{CSH}	Chip select hold time	10	-		
WR	t_{WC}	Write cycle	100	-	ns	-
	t_{WRH}	Control pulse "H" duration	20	-		
	t_{WRL}	Control pulse "L" duration	20	-		
RD	t_{RC}	Read cycle (ID)	150	-	ns	When read ID data
	t_{RDH}	Control pulse "H" duration (ID)	40	-		
	t_{RDL}	Control pulse "L" duration (ID)	50	-		
RD	t_{RCFM}	Read cycle (FM)	250	-	ns	When read from frame memory
	t_{RDHFM}	Control pulse "H" duration (FM)	50	-		
	t_{RDLFM}	Control pulse "L" duration (FM)	150	-		
D[17:0]	t_{DST}	Data setup time	20	-	ns	For maximum $C_L=30pF$ For minimum $C_L=8pF$
	t_{DHT}	Data hold time	20	-		
	t_{RAT}	Read access time (ID)	-	70		
	t_{RATFM}	Read access time (FM)	-	100		
	t_{ODH}	Output disable time	20	80		

CPU Interface Timing Parameters

1.1.3 CPU Interface Register write/read timing

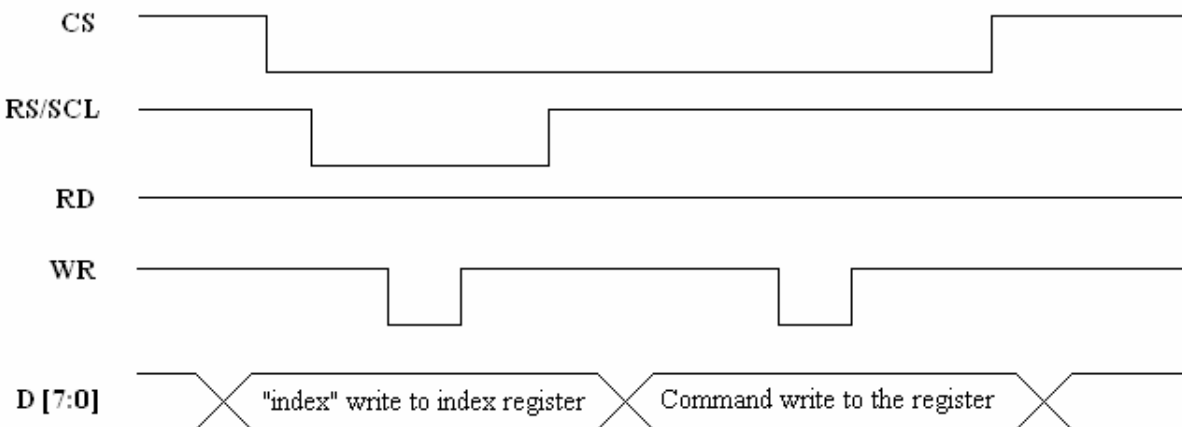

System Bus Interface Write Register Timing

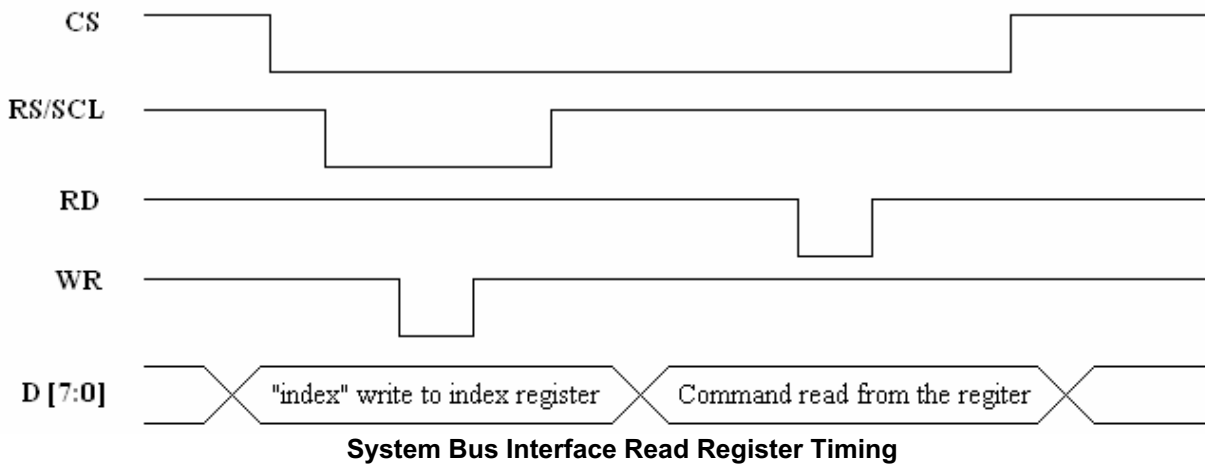

1.2 Reset Timing

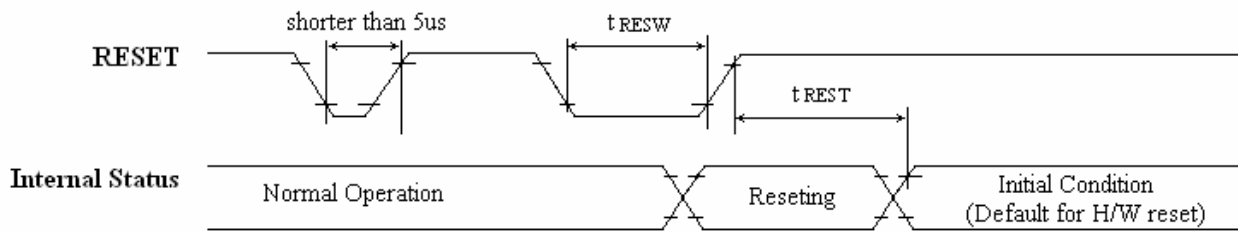

Reset timing

Reset input timing

Symbol	Parameter	Related Pins	Spec.			Note	Unit
			Min.	Typ.	Max.		
t_{RESW}	Reset low pulse width	RESET	10	-	-	-	us
t_{REST}	Reset complete time	-	-	-	5	When reset applied during "Sleep In mode"	ms
		-	-	-	120	When reset applied during "Sleep Out mode"	ms

2 POWER ON/OFF SEQUENCE

2.1 POWER ON SEQUENCE

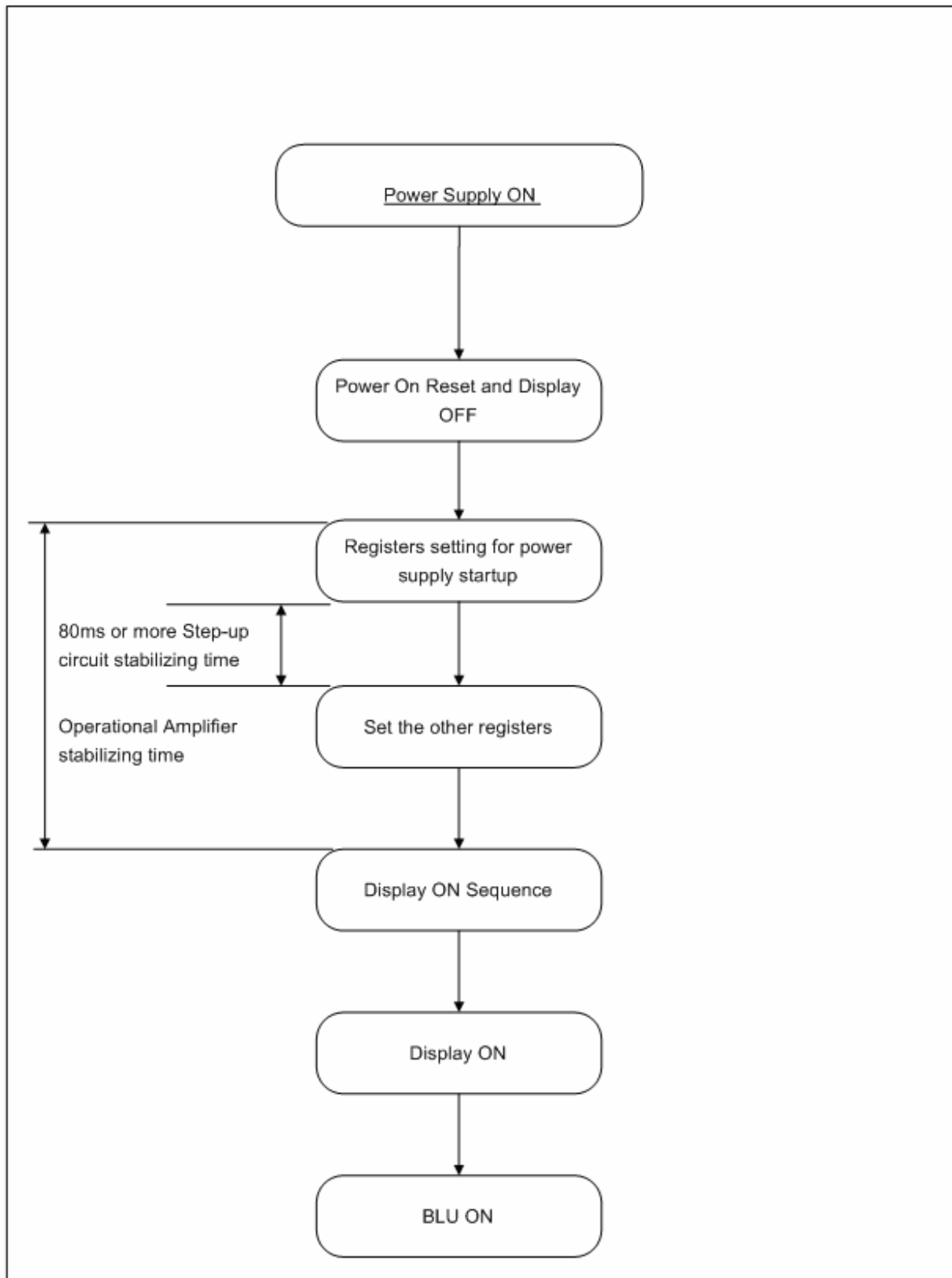

2.2 POWER OFF

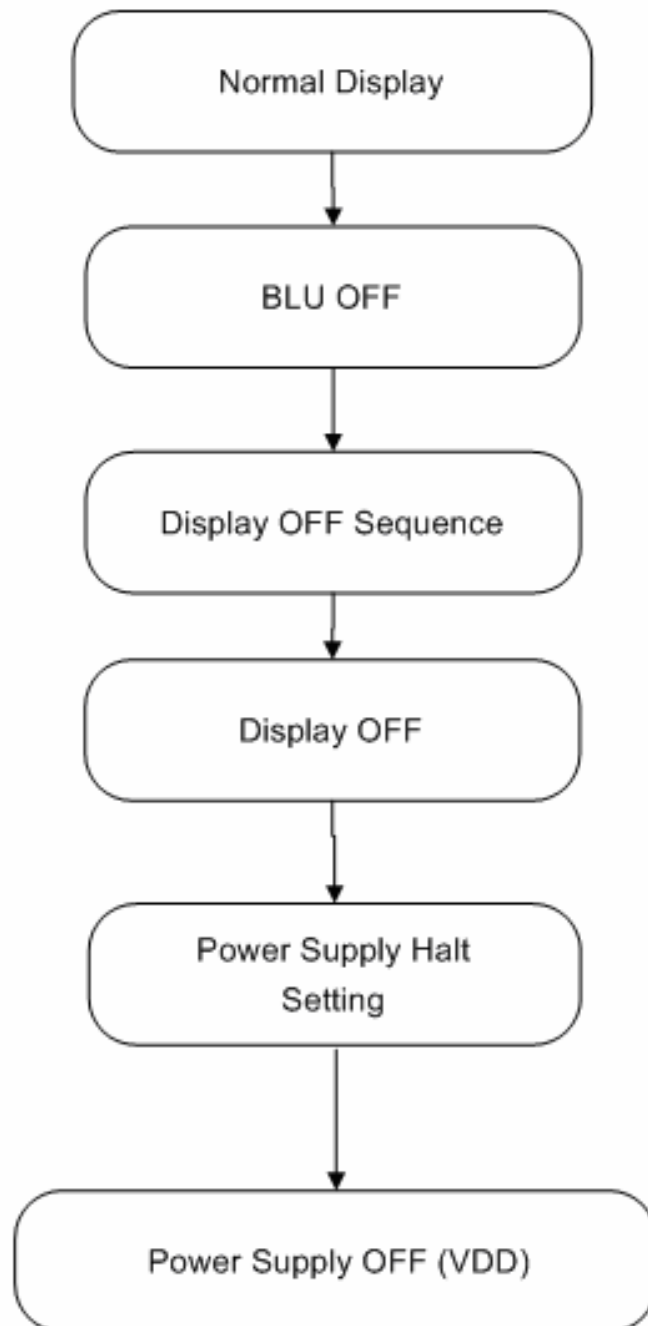



■ RELIABILITY TEST

No.	Test Item	Test Condition	Remark
1	High Temperature Storage	$80 \pm 2^{\circ}\text{C}/240$ hours	IEC60068-2-1 GB2423.2
2	Low Temperature Storage	$-30 \pm 2^{\circ}\text{C}/240$ hours	IEC60068-2-1 GB2423.1
3	High Temperature Operating	$70 \pm 2^{\circ}\text{C}/240$ hours	IEC60068-2-1 GB2423.2
4	Low Temperature Operating	$-20 \pm 2^{\circ}\text{C}/240$ hours	IEC60068-2-1 GB2423.1
5	Temperature Cycle storage	$-30 \pm 2^{\circ}\text{C} \sim 25 \sim 70 \pm 2^{\circ}\text{C} \times 20$ cycles (30min.) (5min.) (30min.)	Start with cold temperature, End with high temperature, IEC60068-2-14 GB2423.22
6	Damp proof Test operating	$40^{\circ}\text{C} \pm 5^{\circ}\text{C} \times 90\%\text{RH}/240$ hours	IEC60068-2-78 GB/T2423.3
7	Vibration Test (non-operation)	Frequency range:10Hz~55Hz, Stroke:1.5mm Sweep:10Hz~55Hz~10Hz 2hours for each direction of X,Y,Z(6 hours for total)	IEC60068-2-6 GB/T2423.10
8	Package drop test	Height:80 cm,1 corner,3 edges,6 surfaces	IEC60068-2-32,GB2423.8
9	ESD test (operation)	C=150pF,R=330 Ω ,5points/panel Air: $\pm 8\text{KV}$,5times Contact: $\pm 4\text{KV}$,5times(Environment: $15^{\circ}\text{C} \sim 35^{\circ}\text{C}$,30%~60%,86Kpa~106Kpa)	IEC61000-4-2 GB/T17626.2
10	Shock(non-operation)	60G 6ms, $\pm X, \pm Y, \pm Z$ 3times each direction	IEC60068-2-27 GB/T2423.5

Note 1:Ts is the temperature of panel's surface.

Note 2:Ta is the ambient temperature of sample.

■ INSPECTION CRITERION

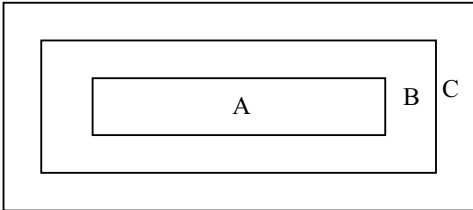
 <p>OUTGOING QUALITY STANDARD</p>	<p>PAGE 1 OF 4</p>
<p>TITLE:FUNCTIONAL TEST & INSPECTION CRITERIA</p>	<p>MDS Product</p>
<p>This specification is made to be used as the standard acceptance/rejection criteria for Color mobile phone LCM.</p> <p>1 Sample plan</p> <p>Sampling plan according to GB/T2828.1-2003/ISO 2859-1: 1999 and ANSI/ASQC Z1.4-1993, normal level 2 and based on:</p> <p>Major defect: AQL 0.65</p> <p>Minor defect: AQL 1.5</p> <p>2. Inspection condition</p> <p>Viewing distance for cosmetic inspection is about 30cm with bare eyes, and under an environment of 20~40W light intensity, all directions for inspecting the sample should be within 45° against perpendicular line.</p> <p>3. Definition of inspection zone in LCD.</p> <div style="text-align: center;">  </div> <p>Zone A: character/Digit area</p> <p>Zone B: viewing area except Zone A (ZoneA+ZoneB=minimum Viewing area)</p> <p>Zone C: Outside viewing area (invisible area after assembly in customer's product)</p> <p>Fig.1 Inspection zones in an LCD.</p> <p>Note: As a general rule, visual defects in Zone C are permissible, when it is no trouble for quality and assembly of customer's product.</p>	

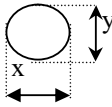

OUTGOING QUALITY STANDARD		PAGE 2 OF 4																												
TITLE:FUNCTIONAL TEST & INSPECTION CRITERIA		MDS Product																												
4. Inspection standards																														
4.1 Major Defect																														
Item No	Items to be inspected	Inspection Standard	Classification of defects																											
4.1.1	All functional defects	1) No display 2) Display abnormally 3) Missing vertical, horizontal segment 4) Short circuit 5) Back-light no lighting, flickering and abnormal lighting.	Major																											
4.1.2	Missing	Missing component																												
4.1.3	Outline dimension	Overall outline dimension beyond the drawing is not allowed.																												
4.2 Cosmetic Defect																														
Item No	Items to be inspected	Inspection Standard	Classification of defects																											
4.2.1	Clear Spots	For dark/white spot, size Φ is defined as $\Phi = \frac{(x+y)}{2}$ 	Minor																											
	Black and white Spot defect Pinhole, Foreign Particle, Dirt under polarizer	1. <table border="1" style="width: 100%; border-collapse: collapse; text-align: center;"> <thead> <tr> <th rowspan="2">Zone Size(mm)</th> <th colspan="3">Acceptable Qty</th> </tr> <tr> <th>A</th> <th>B</th> <th>C</th> </tr> </thead> <tbody> <tr> <td>$\Phi \leq 0.10$</td> <td colspan="3">Ignore</td> </tr> <tr> <td>$0.10 < \Phi \leq 0.15$</td> <td colspan="3">2</td> </tr> <tr> <td>$0.15 < \Phi \leq 0.20$</td> <td colspan="3">1</td> </tr> <tr> <td>$\Phi > 0.20$</td> <td colspan="3">0</td> </tr> </tbody> </table>		Zone Size(mm)	Acceptable Qty			A	B	C	$\Phi \leq 0.10$	Ignore			$0.10 < \Phi \leq 0.15$	2			$0.15 < \Phi \leq 0.20$	1			$\Phi > 0.20$	0						
Zone Size(mm)	Acceptable Qty																													
	A	B	C																											
$\Phi \leq 0.10$	Ignore																													
$0.10 < \Phi \leq 0.15$	2																													
$0.15 < \Phi \leq 0.20$	1																													
$\Phi > 0.20$	0																													
	Dim Spots	2. <table border="1" style="width: 100%; border-collapse: collapse; text-align: center;"> <thead> <tr> <th rowspan="2">2. Zone Size(mm)</th> <th colspan="3">Acceptable Qty</th> </tr> <tr> <th>A</th> <th>B</th> <th>C</th> </tr> </thead> <tbody> <tr> <td>$\Phi \leq 0.2$</td> <td colspan="3">Ignore</td> </tr> <tr> <td>$0.20 < \Phi \leq 0.40$</td> <td colspan="3">3</td> </tr> <tr> <td>$0.40 < \Phi \leq 0.60$</td> <td colspan="3">2</td> </tr> <tr> <td>$0.60 < \Phi \leq 0.80$</td> <td colspan="3">1</td> </tr> <tr> <td>$0.80 < \Phi$</td> <td colspan="3">0</td> </tr> </tbody> </table>	2. Zone Size(mm)	Acceptable Qty			A	B	C	$\Phi \leq 0.2$	Ignore			$0.20 < \Phi \leq 0.40$	3			$0.40 < \Phi \leq 0.60$	2			$0.60 < \Phi \leq 0.80$	1			$0.80 < \Phi$	0			Minor
2. Zone Size(mm)	Acceptable Qty																													
	A	B	C																											
$\Phi \leq 0.2$	Ignore																													
$0.20 < \Phi \leq 0.40$	3																													
$0.40 < \Phi \leq 0.60$	2																													
$0.60 < \Phi \leq 0.80$	1																													
$0.80 < \Phi$	0																													

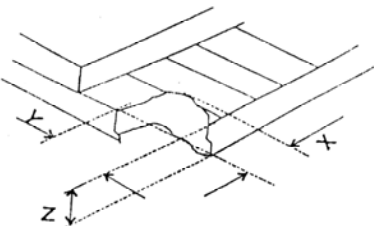
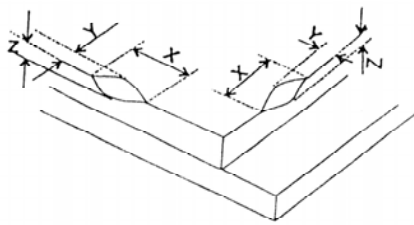
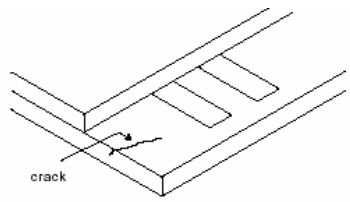

OUTGOING QUALITY STANDARD		PAGE 3 OF 4					
TITLE: FUNCTIONAL TEST & INSPECTION CRITERIA		MDS Product					
4.2. Cosmetic Defect							
Item No	Items to be inspected	Inspection Standard			Classification of defects		
4.2.2	Line defect Black line, White line, Foreign material under polarizer,	Size(mm)		Acceptable Qty		Minor	
		L(Length)	W(Width)	Zone			
				A	B		C
		Ignore	$W \leq 0.02$	Ignore			Ignore
		$L \leq 3.0$	$0.02 < W \leq 0.03$	2			
		$L \leq 2.0$	$0.03 < W \leq 0.05$	1			
	$0.05 < W$	Define as spot defect					
4.2.3	Polarizer scratch	If the Polarizer scratch can be seen after mobile phone cover assembling or in the operating condition, judge by the line defect of 4.2.2.			Minor		
		If the Polarizer scratch can be seen only in non-operating condition or some special angle, judge by the following.					
		Size(mm)		Acceptable Qty			
		L(Length)	W(Width)	Zone			
				A		B	C
		Ignore	$W \leq 0.03$	Ignore		Ignore	
$5.0 < L \leq 10.0$	$0.03 < W \leq 0.05$	2					
$L \leq 5.0$	$0.05 < W \leq 0.08$	1					
	$0.08 < W$	0					
4.2.4	Polarize Air bubble	Air bubbles between glass & polarizer			Minor		
		2. Zone Size(mm)	Acceptable Qty				
			A	B		C	
		$\Phi \leq 0.2$	Ignore			Ignore	
		$0.20 < \Phi \leq 0.30$	2				
		$0.30 < \Phi \leq 0.50$	1				
$0.50 < \Phi$	0						

OUTGOING QUALITY STANDARD		PAGE 4 OF 4							
TITLE:FUNCTIONAL TEST & INSPECTION CRITERIA		MDS Product							
4.3. Cosmetic Defect									
Item No	Items to be inspected	Inspection Standard	Classification of defects						
4.3.5	Glass defect	(i) Chips on corner  <table border="1" data-bbox="507 784 1093 873"> <tr> <td>X</td> <td>Y</td> <td>Z</td> </tr> <tr> <td>≤2.0</td> <td>≤S</td> <td>Disregard</td> </tr> </table> Notes: S=contact pad length Chips on the corner of terminal shall not be allowed to extend into the ITO pad or expose perimeter seal.	X	Y	Z	≤2.0	≤S	Disregard	Minor
		X	Y	Z					
		≤2.0	≤S	Disregard					
(ii)Usual surface cracks  <table border="1" data-bbox="486 1254 1109 1344"> <tr> <td>X</td> <td>Y</td> <td>Z</td> </tr> <tr> <td>≤3.0</td> <td><Inner border line of the seal</td> <td>Disregard</td> </tr> </table>	X	Y	Z	≤3.0	<Inner border line of the seal	Disregard	Minor		
X	Y	Z							
≤3.0	<Inner border line of the seal	Disregard							
(iii) Crack Cracks tend to break are not allowed. 	Major								
4.3.6	Parts alignment	1) Not allow IC and FPC/heat-seal lead width is more than 50% beyond lead pattern. 2) Not allow chip or solder component is off center more than 50% of the pad outline.	Minor						
4.3.7	SMT	According to the <Acceptability of electronic assemblies> IPC-A-610C class 2 standard. Component missing or function defect are Major defect, the others are Minor defect.							

■ PRECAUTIONS FOR USING LCD MODULES

Handing Precautions

(1) The display panel is made of glass and polarizer. As glass is fragile. It tends to become or chipped during handling especially on the edges. Please avoid dropping or jarring. Do not subject it to a mechanical shock by dropping it or impact.

(2) If the display panel is damaged and the liquid crystal substance leaks out, be sure not to get any in your mouth. If the substance contacts your skin or clothes, wash it off using soap and water.

(3) Do not apply excessive force to the display surface or the adjoining areas since this may cause the color tone to vary. Do not touch the display with bare hands. This will stain the display area and degraded insulation between terminals (some cosmetics are determined to the polarizer).

(4) The polarizer covering the display surface of the LCD module is soft and easily scratched. Handle this polarizer carefully. Do not touch, push or rub the exposed polarizers with anything harder than an HB pencil lead (glass, tweezers, etc.). Do not put or attach anything on the display area to avoid leaving marks on. Condensation on the surface and contact with terminals due to cold will damage, stain or dirty the polarizer. After products are tested at low temperature they must be warmed up in a container before coming is contacting with room temperature air.

(5) If the display surface becomes contaminated, breathe on the surface and gently wipe it with a soft dry cloth. If it is heavily contaminated, moisten cloth with one of the following solvents

- Isopropyl alcohol
- Ethyl alcohol

Do not scrub hard to avoid damaging the display surface.

(6) Solvents other than those above-mentioned may damage the polarizer. Especially, do not use the following.

- Water
- Ketone
- Aromatic solvents

Wipe off saliva or water drops immediately, contact with water over a long period of time may cause deformation or color fading. Avoid contacting oil and fats.

(7) Exercise care to minimize corrosion of the electrode. Corrosion of the electrodes is accelerated by water droplets, moisture condensation or a current flow in a high-humidity environment.

(8) Install the LCD Module by using the mounting holes. When mounting the LCD module make sure it is free of twisting, warping and distortion. In particular, do not forcibly pull or bend the I/O cable or the backlight cable.

(9) Do not attempt to disassemble or process the LCD module.

(10) NC terminal should be open. Do not connect anything.

(11) If the logic circuit power is off, do not apply the input signals.

(12) Electro-Static Discharge Control, Since this module uses a CMOS LSI, the same careful attention should be paid to electrostatic discharge as for an ordinary CMOS IC. To prevent destruction of the elements by static electricity, be careful to maintain an optimum work environment.

- Before remove LCM from its packing case or incorporating it into a set, be sure the module and your body have the same electric potential. Be sure to ground the body when handling the LCD modules.

- Tools required for assembling, such as soldering irons, must be properly grounded. make certain the AC power source for the soldering iron does not leak. When using an electric screwdriver to attach LCM, the screwdriver should be of ground potentiality to minimize as much as possible any transmission of electromagnetic waves produced sparks coming from the commutator of the motor.

- To reduce the amount of static electricity generated, do not conduct assembling and other work under dry conditions. To reduce the generation of static electricity be careful that the air in the work is not too dried. A relative humidity of 50%-60% is recommended. As far as possible make the electric potential of your work clothes and that of the work bench the ground potential

- The LCD module is coated with a film to protect the display surface. Exercise care when peeling off this protective film since static electricity may be generated



(13) Since LCM has been assembled and adjusted with a high degree of precision, avoid applying excessive shocks to the module or making any alterations or modifications to it.

- Do not alter, modify or change the shape of the tab on the metal frame.
- Do not make extra holes on the printed circuit board, modify its shape or change the positions of components to be attached.
- Do not damage or modify the pattern writing on the printed circuit board.
- Absolutely do not modify the zebra rubber strip (conductive rubber) or heat seal connector.
- Except for soldering the interface, do not make any alterations or modifications with a soldering iron.
- Do not drop, bend or twist LCM.

Storage Precautions

When storing the LCD modules, the following precaution is necessary.

- (1) Store them in a sealed polyethylene bag. If properly sealed, there is no need for the dessicant.
- (2) Store them in a dark place. Do not expose to sunlight or fluorescent light, keep the temperature between 0°C and 35°C.
- (3) The polarizer surface should not come in contact with any other objects. (We advise you to store them in the container in which they were shipped).

Others

Liquid crystals solidify under low temperature (below the storage temperature range) leading to defective orientation or the generation of air bubbles (black or white). Air bubbles may also be generated if the module is subject to a low temperature.

If the LCD modules have been operating for a long time showing the same display patterns, the display patterns may remain on the screen as ghost images and a slight contrast irregularity may also appear. A normal operating status can be regained by suspending use for some time. It should be noted that this phenomenon does not adversely affect performance reliability.

To minimize the performance degradation of the LCD modules resulting from destruction caused by static electricity etc., exercise care to avoid holding the following sections when handling the modules.

- Exposed area of the printed circuit board.
- Terminal electrode sections.

Handling precaution for LCM

LCM is easy to be damaged.
Please note below and be careful for handling!

Correct handling:



As above picture, please handle with anti-static gloves around LCM edges.

Incorrect handling:

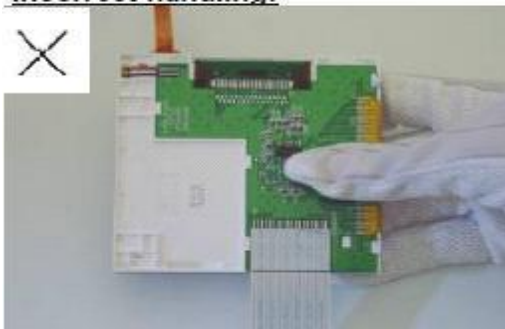

Please don't touch IC directly.



Please don't stack LCM.

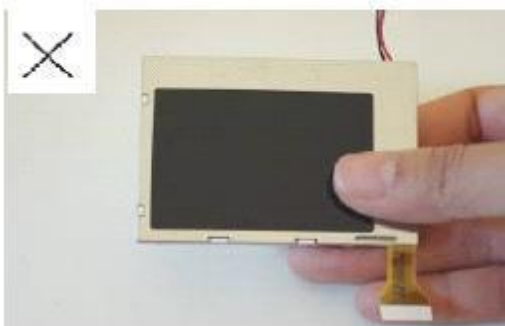

Please don't hold the surface of panel.

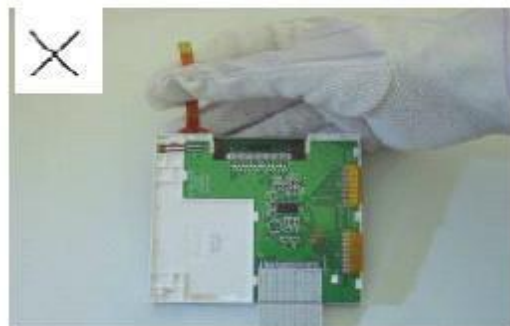

Please don't stretch interface of output, such as FPC cable.

Handling precaution for LCD

LCD is easy to be damaged.
Please note below and be careful for handling!

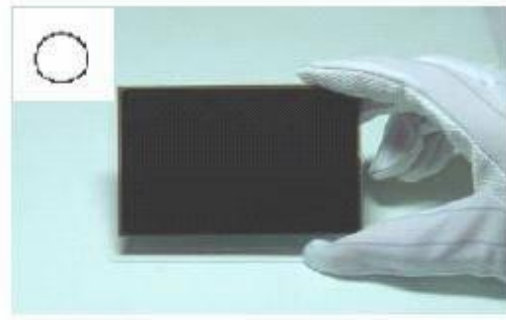
Correct handling:

As above photo, please handle with anti-static gloves around LCD edges.

Incorrect handling:

Please don't stack the LCDS.

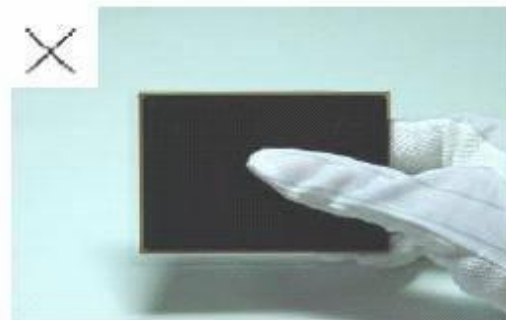

Please don't hold the surface of LCD.

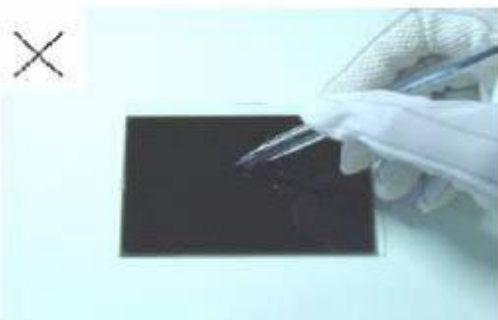

Please don't operate with sharp stick such as pens.

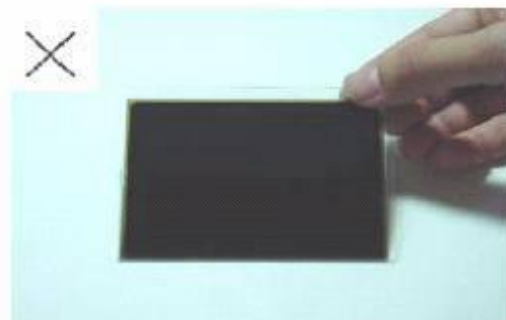

Please don't touch ITO glass without anti-static gloves.

Storage Precautions

When storing the LCD modules, the following precaution is necessary.

- (1) Store them in a sealed polyethylene bag. If properly sealed, there is no need for the dessicant.
- (2) Store them in a dark place. Do not expose to sunlight or fluorescent light, keep the temperature between 0°C and 35°C, and keep the relative humidity between 40%RH and 60%RH.
- (3) The polarizer surface should not come in contact with any other objects. (We advise you to store them in the anti-static electricity container in which they were shipped.

Others

Liquid crystals solidify under low temperature (below the storage temperature range) leading to defective orientation or the generation of air bubbles (black or white). Air bubbles may also be generated if the module is subject to a low temperature.

If the LCD modules have been operating for a long time showing the same display patterns, the display patterns may remain on the screen as ghost images and a slight contrast irregularity may also appear. A normal operating status can be regained by suspending use for some time. It should be noted that this phenomenon does not adversely affect performance reliability.

To minimize the performance degradation of the LCD modules resulting from destruction caused by static electricity etc., exercise care to avoid holding the following sections when handling the modules.

- Exposed area of the printed circuit board.
- Terminal electrode sections.

USING LCD MODULES

Installing LCD Modules

The hole in the printed circuit board is used to fix LCM as shown in the picture below. Attend to the following items when installing the LCM.

- (1) Cover the surface with a transparent protective plate to protect the polarizer and LC cell.

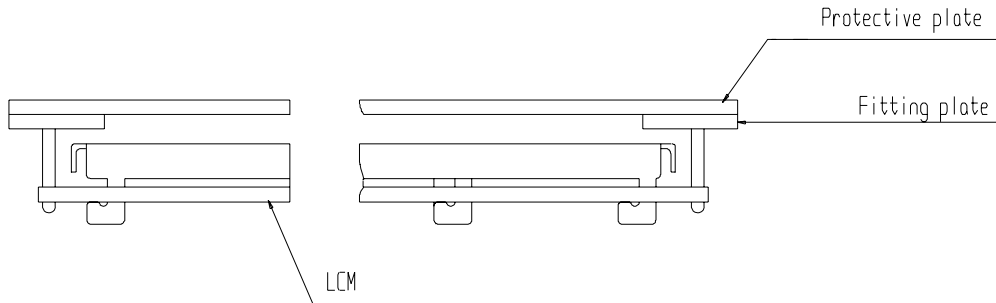

- (2) When assembling the LCM into other equipment, the spacer to the bit between the LCM and the fitting plate should have enough height to avoid causing stress to the module surface, refer to the individual specifications for measurements. The measurement tolerance should be ± 0.1 mm.

Precaution for assemble the module with BTB connector:

Please note the position of the male and female connector position, don't assemble or assemble like the method which the following picture shows

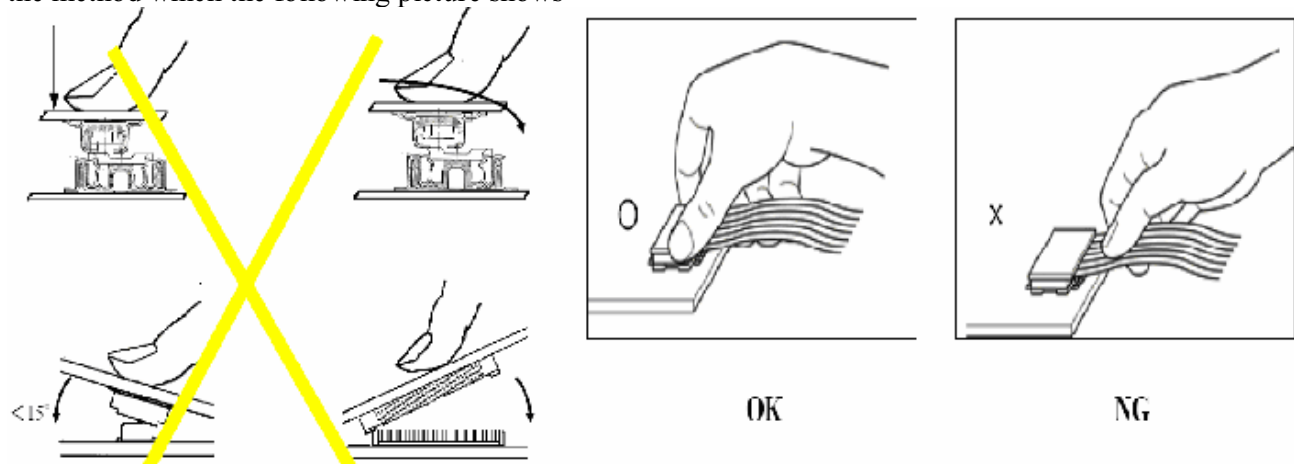

Precaution for soldering to the LCM

	Hand soldering	Machine drag soldering	Machine press soldering
No ROHS product	290°C ~350°C. Time : 3-5S.	330°C ~350°C. Speed : 4-8 mm/s.	300°C ~330°C. Time : 3-6S. Press: 0.8~1.2Mpa
ROHS product	340°C ~370°C. Time : 3-5S.	350°C ~370°C. Time : 4-8 mm/s.	330°C ~360°C. Time : 3-6S. Press: 0.8~1.2Mpa

(1) If soldering flux is used, be sure to remove any remaining flux after finishing to soldering operation. (This does not apply in the case of a non-halogen type of flux.) It is recommended that you protect the LCD surface with a cover during soldering to prevent any damage due to flux spatters.

(2) When soldering the electroluminescent panel and PC board, the panel and board should not be detached more than three times. This maximum number is determined by the temperature and time conditions mentioned above, though there may be some variance depending on the temperature of the soldering iron.

(3) When remove the electroluminescent panel from the PC board, be sure the solder has completely melted, the soldered pad on the PC board could be damaged.

Precautions for Operation

(1) Viewing angle varies with the change of liquid crystal driving voltage (VLCD). Adjust VLCD to show the best contrast.

(2) It is an indispensable condition to drive LCD's within the specified voltage limit since the higher voltage then the limit cause the shorter LCD life. An electrochemical reaction due to direct current causes LCD's undesirable deterioration, so that the use of direct current drive should be avoided.

(3) Response time will be extremely delayed at lower temperature than the operating temperature range and on the other hand at higher temperature LCD's show dark color in them. However those phenomena do not mean malfunction or out of order with LCD's, Which will come back in the specified operating temperature.

(4) If the display area is pushed hard during operation, the display will become abnormal. However, it will return to normal if it is turned off and then back on.

(5) A slight dew depositing on terminals is a cause for electro-chemical reaction resulting in terminal open circuit. Usage under the maximum operating temperature,50%RH or less is required.

(6) Input each signal after the positive/negative voltage becomes stable.

(7) Please keep the temperature within specified range for use and storage. Polarization degradation, bubble generation or polarizer peel-off may occur with high temperature and high humidity.

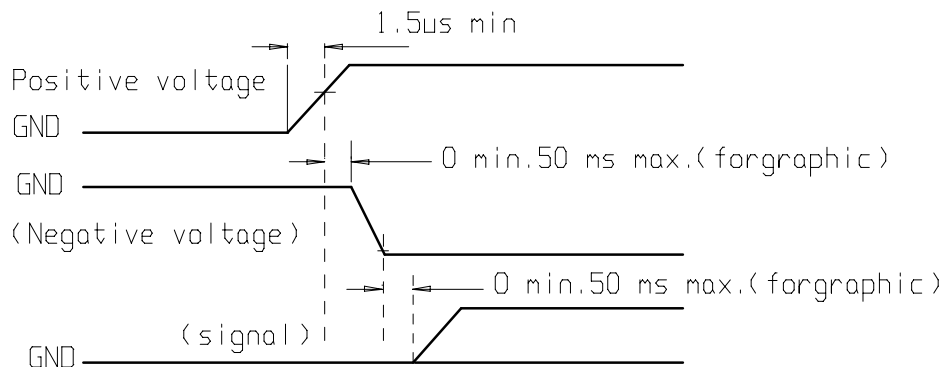

**Safety**

(1) It is recommended to crush damaged or unnecessary LCDs into pieces and wash them off with solvents such as acetone and ethanol, which should later be burned.

(2) If any liquid leaks out of a damaged glass cell and comes in contact with the hands, wash off thoroughly with soap and water.

Limited Warranty

Unless agreed between Multi-Inno and customer, Multi-Inno will replace or repair any of its LCD modules which are found to be functionally defective when inspected in accordance with Multi-Inno LCD acceptance standards (copies available upon request) for a period of one year from date of production. Cosmetic/visual defects must be returned to Multi-Inno within 90 days of shipment. Confirmation of such date shall be based on data code on product. The warranty liability of Multi-Inno limited to repair and/or replacement on the terms set forth above. Multi-Inno will not be responsible for any subsequent or consequential events.

Return LCM under warranty

No warranty can be granted if the precautions stated above have been disregarded. The typical examples of violations are :

- Broken LCD glass.
- PCB eyelet is damaged or modified.
- PCB conductors damaged.
- Circuit modified in any way, including addition of components.
- PCB tampered with by grinding, engraving or painting varnish.
- Soldering to or modifying the bezel in any manner.

Module repairs will be invoiced to the customer upon mutual agreement. Modules must be returned with sufficient description of the failures or defects. Any connectors or cable installed by the customer must be removed completely without damaging the PCB eyelet, conductors and terminals.

■ PRIOR CONSULT MATTER

1. ① For Multi-Inno standard products, we keep the right to change material, process ... for improving the product property without notice on our customer.
② For OEM products, if any change needed which may affect the product property, we will consult with our customer in advance.
2. If you have special requirement about reliability condition, please let us know before you start the test on our samples.