



MULTI-INNO TECHNOLOGY CO., LTD.

www.multi-inno.com

LCD MODULE SPECIFICATION

Model : MI0240ST-7

For Customer's Acceptance:

Customer	
Approved	
Comment	

Revision	1.0
Engineering	
Date	2012-10-21
Our Reference	



CONTENTS

- GENERAL INFORMATION
- EXTERNAL DIMENSIONS
- ABSOLUTE MAXIMUM RATINGS
- ELECTRICAL CHARACTERISTICS
- BACKLIGHT CHARACTERISTICS
- ELECTRO-OPTICAL CHARACTERISTICS
- INTERFACE DESCRIPTION
- TOUCH SCREEN PANEL SPECIFICATION
- APPLICATION NOTES
- RELIABILITY TEST
- INSPECTION CRITERION
- PRECAUTIONS FOR USING LCD MODULES
- PRIOR CONSULT MATTER

**■ GENERAL INFORMATION**

Item	Contents	Unit
LCD type	TFT/Transmissive/Normally white	/
Size	2.4	Inch
Viewing direction	12:00	O' Clock
Gray scale inversion direction	6:00	O' Clock
LCM (W × H × D)	42.72×60.26×3.60	mm ³
Active area (W×H)	36.72×48.96	mm ²
Pixel pitch (W×H)	0.153×0.153	mm ²
Number of dots	240 (RGB) × 320	/
Driver IC	ILI9341	/
Backlight type	4 LEDs	/
Interface type	CPU 8/16 bits	/
Color depth	65K/262K	/
Pixel configuration	R.G.B vertical stripe	/
Surface treatment(Up polarizer)	Clear type(3H)	/
Input voltage	2.8	V
With/Without TSP	With TSP	/
Weight	TBD	g

Note 1: Viewing direction for best image quality is different from TFT definition, there is a 180 degree shift.

Note 2 : RoHS compliant;

Note 3: LCM weight tolerance: ± 5% .

EXTERNAL DIMENSIONS

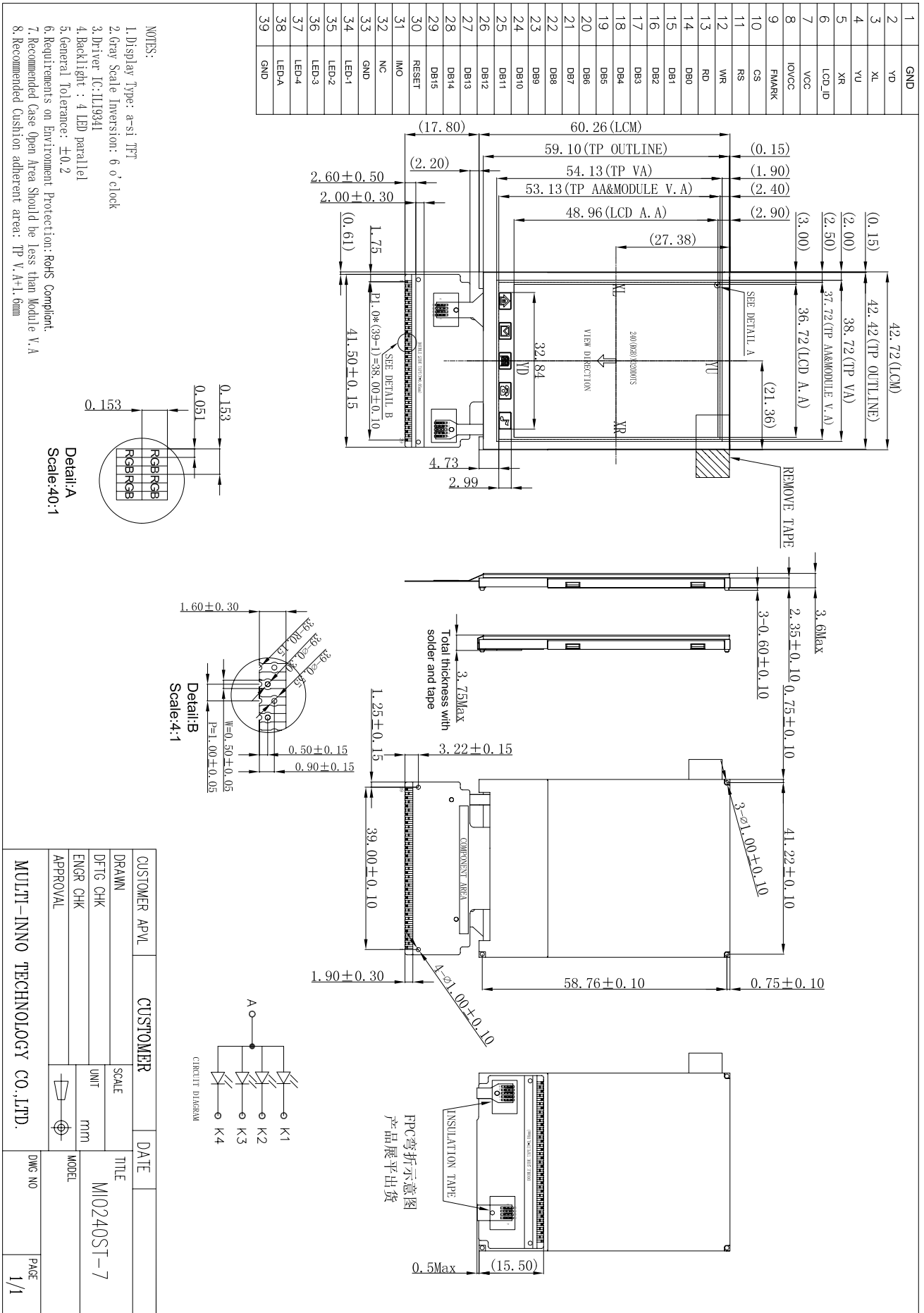

■ ABSOLUTE MAXIMUM RATINGS

Parameter	Symbol	Min	Max	Unit
Supply voltage for logic	V_{CC}, IOV_{CC}	-0.3	4.6	V
Input voltage	V_{IN}	-0.3	$IOV_{CC} + 0.5$	V
Operating temperature	T_{OP}	-20	70	°C
Storage temperature	T_{ST}	-30	80	°C
Humidity	RH		90%(Max60°C)	RH

■ ELECTRICAL CHARACTERISTICS

DC CHARACTERISTICS

 GND=0V, $T_a=25^\circ\text{C}$

Item	Symbol	MIN	TYP	MAX	Unit	Remark	
Logic Supply Voltage	IOVCC	1.65	1.8/2.8	3.3	V		
Analog Supply Voltage	VCC	2.3	2.8	3.3	V		
Input Signal Voltage	Low Level	V_{IL}	0.8x IOVCC	-	IOVCC	V	DB0-DB15, IM0, RD, RS, CS, WR, RESET
	High Level	V_{IH}	-	-	0.2x IOVCC	V	
Output Signal Voltage	Low Level	V_{OL}	0.8x IOVCC	-	-	V	
	High Level	V_{OH}	-	--	0.2x IOVCC	V	
(Panel+ LSI) Power Consumption	Black Mode (60Hz)	-	21.64	-	-	mW	
	8 Color Mode	-	5.897	-	-	mW	
	Sleeping Mode	-	0.095	-	-	mW	

■ BACKLIGHT CHARACTERISTICS

Item	Symbol	Min	Typ	Max	Unit	Remark
Forward Current	I_F	-	15	-	mA	For each LED
Forward Voltage	V_F	2.9	3.2	3.4	V	For each LED
Power Consumption	W_{BL}	-	192	-	mW	4 LEDs

Note1: Figure below shows the connection of backlight LED.

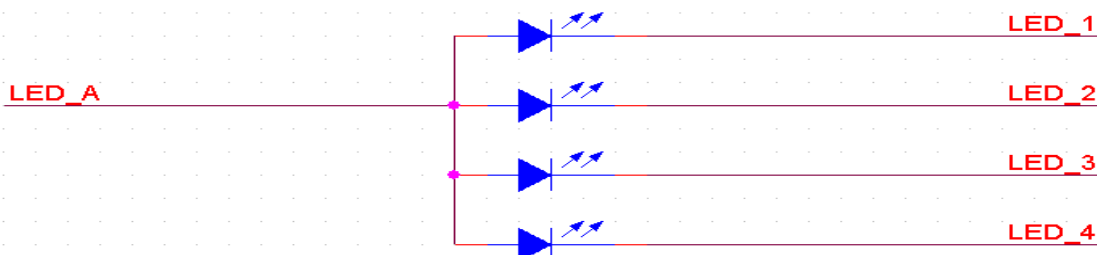

Note 2: One LED: $1/4 \times I_F = 15 \text{ mA}$, $V_F = 3.2 \text{ V}$

■ELECTRO-OPTICAL CHARACTERISTICS

Item	Symbol	Condition	Min	Typ	Max	Unit	Remark	Note
Response time	Tr+Tf	$\theta=0^\circ$ $\varnothing=0^\circ$ $T_a=25^\circ\text{C}$	---	20	30	ms	FIG 1.	4
Contrast ratio	Cr		400	500	---	---	FIG 2.	1
Luminance uniformity	δ WHITE		---	80	---	%	FIG 2.	3
Surface Luminance	Lv		210	250	---	cd/m ²	FIG 2.	2
Viewing angle range	θ	$\varnothing = 90^\circ$	50	60	---	deg	FIG 3.	6
		$\varnothing = 270^\circ$	60	70	---	deg	FIG 3.	
		$\varnothing = 0^\circ$	60	70	---	deg	FIG 3.	
		$\varnothing = 180^\circ$	60	70	---	deg	FIG 3.	
CIE (x, y) chromaticity	Red	x	0.542	0.592	0.642	FIG 2.	5	
		y	0.294	0.344	0.394			
	Green	x	0.285	0.332	0.385			
		y	0.531	0.581	0.631			
	Blue	x	0.099	0.149	0.199			
		y	0.054	0.104	0.154			
	White	x	0.240	0.290	0.340			
		y	0.270	0.320	0.370			
NTSC	-	-	---	53	---	%	-	-

Note 1. Contrast Ratio(CR) is defined mathematically as For more information see FIG 2.

$$\text{Contrast Ratio} = \frac{\text{Average Surface Luminance with all white pixels (P1, P2, P3, P4, P5)}}{\text{Average Surface Luminance with all black pixels (P1, P2, P3, P4, P5)}}$$

Note 2. Surface luminance is the LCD surface from the surface with all pixels displaying white. For more information see FIG 2.

$$L_v = \text{Average Surface Luminance with all white pixels (P1, P2, P3, P4, P5)}$$

Note 3. The uniformity in surface luminance , δ WHITE is determined by measuring luminance at each test position 1 through 5, and then dividing the maximum luminance of 5 points luminance by minimum luminance of 5 points luminance. For more information see FIG 2.

$$\delta \text{ WHITE} = \frac{\text{Minimum Surface Luminance with all white pixels (P1, P2, P3, P4, P5)}}{\text{Maximum Surface Luminance with all white pixels (P1, P2, P3, P4, P5)}}$$

Note 4. Response time is the time required for the display to transition from White to black(Rise Time, Tr) and from black to white(Decay Time, Tf). For additional information see FIG 1. The test equipment is Autronic-Melchers's ConoScope. Series.

Note 5. CIE (x, y) chromaticity, The x, y value is determined by measuring luminance at each test position 1 through 5, and then make average value.

Note 6. Viewing angle is the angle at which the contrast ratio is greater than 2. For TFT module the contrast ratio is greater than 10. The angles are determined for the horizontal or x axis and the vertical or y axis with respect to the z axis which is normal to the LCD surface. For more information see FIG 3.

Note 7. For viewing angle and response time testing, the testing data is base on Autronic-Melchers's ConoScope. Series Instruments For contrast ratio, Surface Luminance, Luminance uniformity, CIE The test data is base on TOPCON's BM-5 photo detector.

FIG.1. The definition of Response Time

The response time is defined as the following figure and shall be measured by switching the input signal for “black” and “white”.

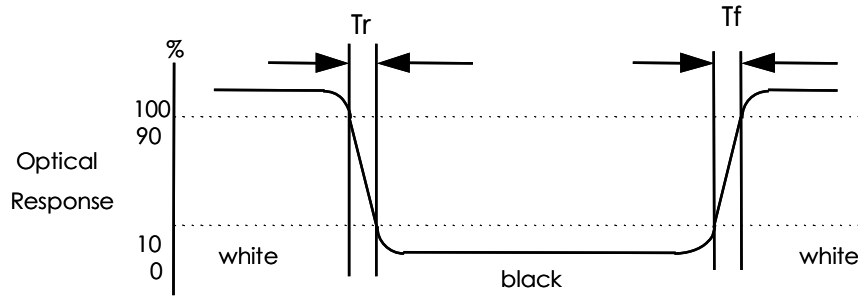

FIG.2. Measuring method for Contrast ratio, surface luminance, Luminance uniformity , CIE (x, y) chromaticity

A : 5 mm
 B : 5 mm
 H, V : Active Area
 Light spot size $\varnothing=7\text{mm}$, 500mm distance from the LCD surface to detector lens
 measurement instrument is TOPCON's luminance meter BM-5

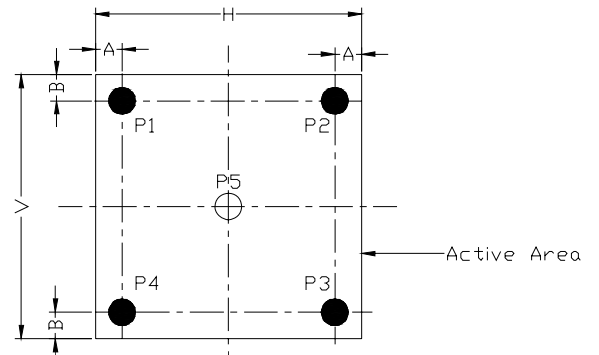
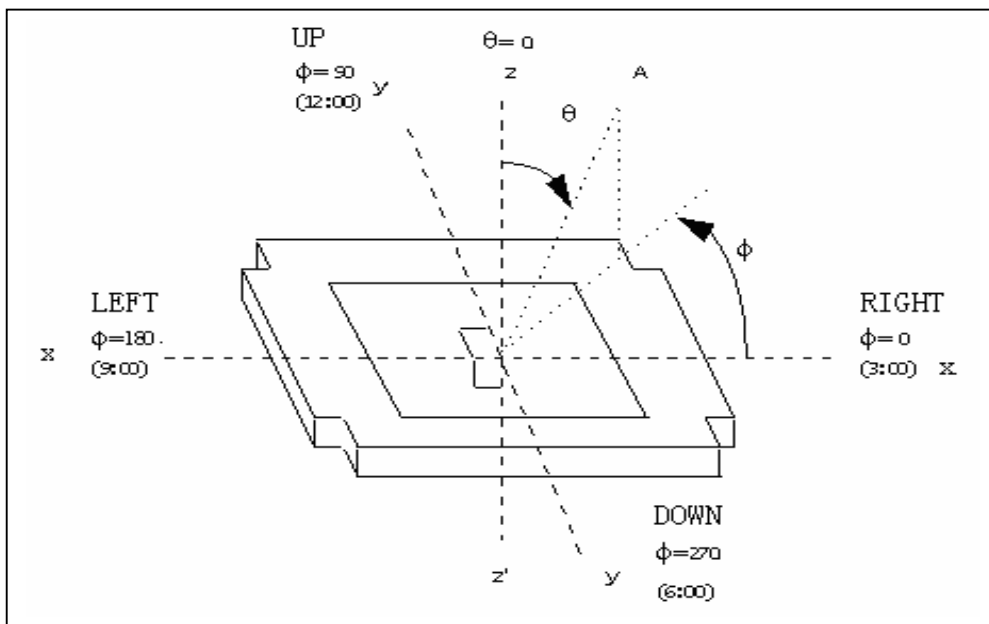

FIG.3. The definition of viewing angle





■ INTERFACE DESCRIPTION

No	Symbol	I/O	Description	Comment
1	GND	P	Power Ground	
2	YD	O	Touch Panel Bottom Side	
3	XL	O	Touch Panel Left Side	
4	YU	O	Touch Panel Up Side	
5	XR	O	Touch Panel Right Side	
6	LCD_ID	O	LCD identify signal. The voltage is about 2.470V when VCC is 2.8V.	
7	VCC	P	Power Supply of Analog	
8	IOVCC	P	Power Supply of Logic	
9	FMARK	O	Tearing effect output pin to synchronize MPU to frame writing	
10	CS	I	Chip select signal	
11	RS	I	Register select signal	
12	WR	I	Write enables signal	
13	RD	I	Read enables signal	
14	DB0	I/O	Data Input	
15	DB1	I/O	Data Input	
16	DB2	I/O	Data Input	
17	DB3	I/O	Data Input	
18	DB4	I/O	Data Input	
19	DB5	I/O	Data Input	
20	DB6	I/O	Data Input	
21	DB7	I/O	Data Input	
22	DB8	I/O	Data Input	
23	DB9	I/O	Data input	
24	DB10	I/O	Data input	
25	DB11	I/O	Data input	
26	DB12	I/O	Data input	
27	DB13	I/O	Data input	
28	DB14	I/O	Data input	
29	DB15	I/O	Data input	
30	RESET	I	Reset signal	
31	IM0	I	Mode select signal	Note2
32	NC	-	Floating	
33	GND	P	Power Ground	
34	LED_1	P	LED light cathode	
35	LED_2	P	LED light cathode	
36	LED_3	P	LED light cathode	
37	LED_4	P	LED light cathode	
38	LED_A	P	LED light anode	
39	GND	P	Power Ground	

Note1: I/O definition: I----Input O---Output P----Power/ Ground NC--- Not Connected

Note2:

IM0	Interface	Data Bus Use	
		Register/Content	GRAM
0	8080 MCU 16_Bit Parallel	DB7~DB0	DB15~DB0
1	8080 MCU 8_Bit Parallel	DB15~DB8	DB15~DB8

Block Diagram

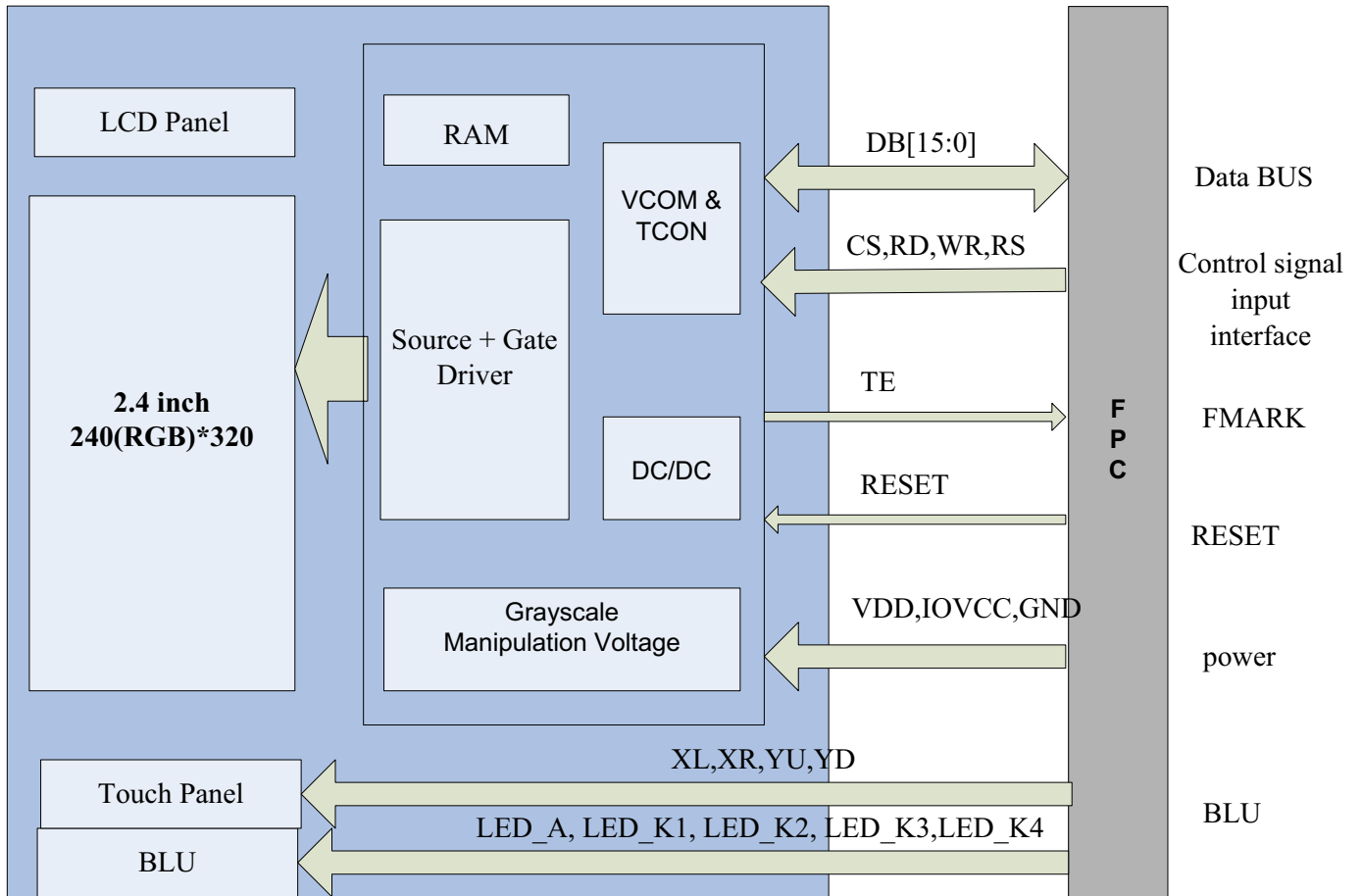

■ TOUCH SCREEN PANEL SPECIFICATIONS

1. Electrical Characteristics

Item	Min	Typ	Max	Unit	Note
Linearity	-	-	1.5	%	X-Axis,Y-Axis
Terminal Resistance	-	TBD	-	Ω	X(Glass side)
	-	TBD	-	Ω	Y(Film side)
Insulation Resistance	10	-	-	M Ω	DC 25V
Operating voltage	-	5	-	V	DC
Response Time	-	-	10	Ms	-
Transmittance	80	-	-	%	-

Note 1) : Do not operate it with a thing except a polyacetal pen(tip R0.8mm or less) or a finger, especially those with hard or sharp tips such as a ball point pen or a mechanical pencil

2. Mechanical & Durability Characteristics

Item	Min	Typ	Max	Unit	Note
Operating Force	50	-	200	G	(1)
Touch Test	1,000,000	-	-	Times	(2)
Handwriting Friction Test	100,000	-	-	Times	(3)
Surface hardness	3	-	-	H	(4)

Note (1) Pen : 0.8N or less (R0.8mm)

Finger : 0.8N or less (0.8mm)

(2) Measurement for Center part of Panel

-Hitting Pad : Tip R8mm Silicon Rubber & Tip R0.8mm Stylus pen

-Lode :150gf

-Speed :2times/sec

-Electric lode :None

(3) Measurement for 2.0mm inside of transparent insulation

-Sliding Pen : Tip R0.8mm Stylus pen

-Lode :150gf

-Speed :60mm/sec

-Sliding Length :25mm

-Electric lode : None

(4) Pressure 500gf , 45deg

3. Integration Design Guide

- Avoid the design that Front-case overlap and press on the active area of the touch-panel.
- Give enough gap (over 0.5mm at compressed) between the front case and touch-panel to protect wrong operating.
- Use a buffer material(Gasket) between the touch-panel and Front-case to protect damage and wrong operating.
- Avoid the design that buffer material overlap and press on the inside of touch-panel viewing area.

APPLICATION NOTES

1. AC Characteristics

1.1 Display parallel 8/16 bite interface timing Characteristics (8080 system)

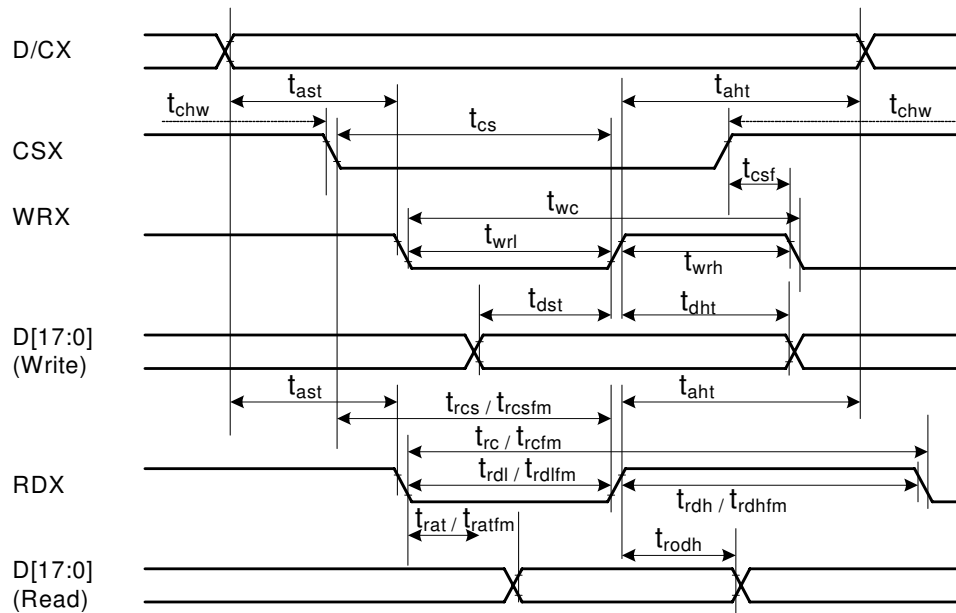

Signal	Symbol	Parameter	min	max	Unit	Description
DCX	t _{ast}	Address setup time	0	-	ns	
	t _{ah}	Address hold time (Write/Read)	0	-	ns	
CSX	t _{chw}	CSX "H" pulse width	0	-	ns	
	t _{cs}	Chip Select setup time (Write)	15	-	ns	
	t _{rcs}	Chip Select setup time (Read ID)	45	-	ns	
	t _{rcsfm}	Chip Select setup time (Read FM)	355	-	ns	
	t _{csf}	Chip Select Wait time (Write/Read)	10	-	ns	
WRX	t _{wc}	Write cycle	66	-	ns	
	t _{wrh}	Write Control pulse H duration	15	-	ns	
	t _{wrl}	Write Control pulse L duration	15	-	ns	
RDX (FM)	t _{rcfm}	Read Cycle (FM)	450	-	ns	
	t _{rdhfm}	Read Control H duration (FM)	90	-	ns	
	t _{rdlfm}	Read Control L duration (FM)	355	-	ns	
RDX (ID)	t _{rc}	Read cycle (ID)	160	-	ns	
	t _{rdh}	Read Control pulse H duration	90	-	ns	
	t _{rdl}	Read Control pulse L duration	45	-	ns	
D[15:0], D[7:0]	t _{dst}	Write data setup time	10	-	ns	For maximum CL=30pF For minimum CL=8pF
	t _{dht}	Write data hold time	10	-	ns	
	t _{rat}	Read access time	-	40	ns	
	t _{ratfm}	Read access time	-	340	ns	
	t _{rod}	Read output disable time	20	80	ns	

Note: $T_a = -30$ to 70 °C, $V_{DDI}=1.65V$ to $3.3V$, $V_{CI}=2.5V$ to $3.3V$, $V_{SS}=0V$

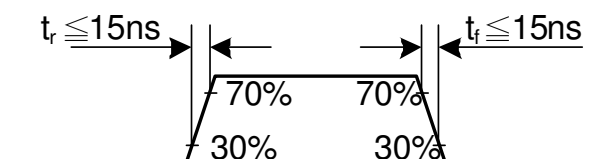

CSX timings :

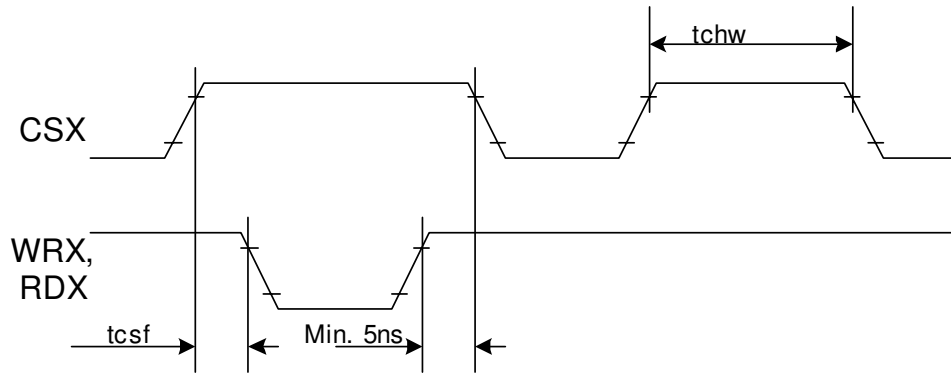

Note: Logic high and low levels are specified as 30% and 70% of VDDI for Input signals.

Write to read or read to write timings:

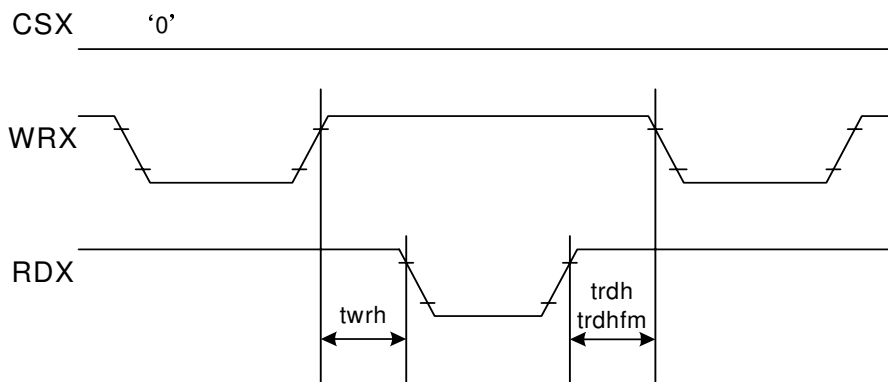

Note: Logic high and low levels are specified as 30% and 70% of VDDI for Input signals.



■ RELIABILITY TEST

No.	Test Item	Test Condition	Remark
1	High Temperature Storage	$80 \pm 2^\circ\text{C}/240$ hours	IEC60068-2-1 GB2423.2
2	Low Temperature Storage	$-30 \pm 2^\circ\text{C}/240$ hours	IEC60068-2-1 GB2423.1
3	High Temperature Operating	$70 \pm 2^\circ\text{C}/240$ hours	IEC60068-2-1 GB2423.2
4	Low Temperature Operating	$-20 \pm 2^\circ\text{C}/240$ hours	IEC60068-2-1 GB2423.1
5	Temperature Cycle storage	$-30 \pm 2^\circ\text{C} \sim 25 \sim 70 \pm 2^\circ\text{C} \times 20$ cycles (30min.) (5min.) (30min.)	Start with cold temperature, with high temperature, IEC60068-2-14 GB2423.22
6	Damp proof Test operating	$60^\circ\text{C} \pm 5^\circ\text{C} \times 90\%\text{RH}/240$ hours	IEC60068-2-78 GB/T2423.3
7	Vibration Test (non-operation)	Frequency range:10Hz~55Hz, Stroke:1.5mm Sweep:10Hz~55Hz~10Hz 2hours for each direction of X,Y,Z(6 hours for total)	IEC60068-2-6 GB/T2423.10
8	Package drop test	Height:80 cm,1 corner,3 edges,6 surfaces	IEC60068-2-32,GB2423.8
9	ESD test (operation)	C=150pF,R=330 Ω ,5points/panel Air: $\pm 8\text{KV}$,5times Contact: $\pm 4\text{KV}$,5times(Environment: $15^\circ\text{C} \sim 35^\circ\text{C}$,30%~60%,86Kpa~106Kpa)	IEC61000-4-2 GB/T17626.2
10	Shock(non-operation)	60G 6ms, $\pm X, \pm Y, \pm Z$ 3times each direction	IEC60068-2-27 GB/T2423.5

Note 1:Ts is the temperature of panel's surface.

Note 2:Ta is the ambient temperature of sample.

■ INSPECTION CRITERIA

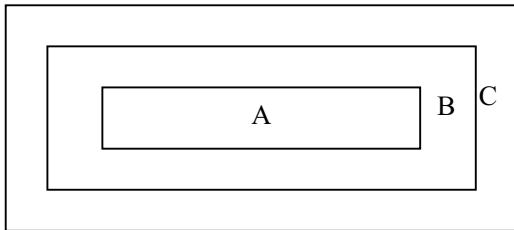
 <p>OUTGOING QUALITY STANDARD</p>	<p>PAGE 1 OF 6</p>
<p>TITLE:FUNCTIONAL TEST & INSPECTION CRITERIA</p>	<p>MDS Product</p>
<p>This specification is made to be used as the standard acceptance/rejection criteria for Color mobile phone LCM.</p> <p>1 Sample plan</p> <p>Sampling plan according to GB/T2828.1-2003/ISO 2859-1: 1999 and ANSI/ASQC Z1.4-1993, normal level 2 and based on:</p> <p>Major defect: AQL 0.65</p> <p>Minor defect: AQL 1.5</p> <p>2. Inspection condition</p> <p>Viewing distance for cosmetic inspection is about 30cm with bare eyes, and under an environment of 20~40W light intensity, all directions for inspecting the sample should be within 45° against perpendicular line.</p> <p>3. Definition of inspection zone in LCD.</p> <div data-bbox="491 1162 1007 1391" data-label="Diagram">  </div> <p>Zone A: character/Digit area</p> <p>Zone B: viewing area except Zone A (ZoneA+ZoneB=minimum Viewing area)</p> <p>Zone C: Outside viewing area (invisible area after assembly in customer's product)</p> <p>Fig.1 Inspection zones in an LCD.</p> <p>Note: As a general rule, visual defects in Zone C are permissible, when it is no trouble for quality and assembly of customer's product.</p>	

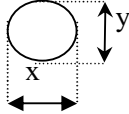
 OUTGOING QUALITY STANDARD		PAGE 2 OF 6																												
TITLE:FUNCTIONAL TEST & INSPECTION CRITERIA		MDS Product																												
4. Inspection standards																														
4.1 Major Defect																														
Item No	Items to be inspected	Inspection Standard	Classification of defects																											
4.1.1	All functional defects	1) No display 2) Display abnormally 3) Missing vertical, horizontal segment 4) Short circuit 5) Back-light no lighting, flickering and abnormal lighting.	Major																											
4.1.2	Missing	Missing component																												
4.1.3	Outline dimension	Overall outline dimension beyond the drawing is not allowed.																												
4.2 Cosmetic Defect																														
Item No	Items to be inspected	Inspection Standard	Classification of defects																											
4.2.1	Clear Spots	For dark/white spot, size Φ is defined as $\Phi = \frac{(x+y)}{2}$ 	Minor																											
	Black and white Spot defect Pinhole, Foreign Particle, Dirt under polarizer	1. <table border="1" data-bbox="427 1240 1145 1617"> <thead> <tr> <th rowspan="2">Zone Size(mm)</th> <th colspan="3">Acceptable Qty</th> </tr> <tr> <th>A</th> <th>B</th> <th>C</th> </tr> </thead> <tbody> <tr> <td>$\Phi \leq 0.10$</td> <td colspan="3">Ignore</td> </tr> <tr> <td>$0.10 < \Phi \leq 0.15$</td> <td colspan="3">2</td> </tr> <tr> <td>$0.15 < \Phi \leq 0.20$</td> <td colspan="3">1</td> </tr> <tr> <td>$\Phi > 0.20$</td> <td colspan="3">0</td> </tr> </tbody> </table>		Zone Size(mm)	Acceptable Qty			A	B	C	$\Phi \leq 0.10$	Ignore			$0.10 < \Phi \leq 0.15$	2			$0.15 < \Phi \leq 0.20$	1			$\Phi > 0.20$	0						
Zone Size(mm)	Acceptable Qty																													
	A	B	C																											
$\Phi \leq 0.10$	Ignore																													
$0.10 < \Phi \leq 0.15$	2																													
$0.15 < \Phi \leq 0.20$	1																													
$\Phi > 0.20$	0																													
	Dim Spots	2. <table border="1" data-bbox="427 1697 1121 2107"> <thead> <tr> <th rowspan="2">2. Zone Size(mm)</th> <th colspan="3">Acceptable Qty</th> </tr> <tr> <th>A</th> <th>B</th> <th>C</th> </tr> </thead> <tbody> <tr> <td>$\Phi \leq 0.2$</td> <td colspan="3">Ignore</td> </tr> <tr> <td>$0.20 < \Phi \leq 0.40$</td> <td colspan="3">3</td> </tr> <tr> <td>$0.40 < \Phi \leq 0.60$</td> <td colspan="3">2</td> </tr> <tr> <td>$0.60 < \Phi \leq 0.80$</td> <td colspan="3">1</td> </tr> <tr> <td>$0.80 < \Phi$</td> <td colspan="3">0</td> </tr> </tbody> </table>	2. Zone Size(mm)	Acceptable Qty			A	B	C	$\Phi \leq 0.2$	Ignore			$0.20 < \Phi \leq 0.40$	3			$0.40 < \Phi \leq 0.60$	2			$0.60 < \Phi \leq 0.80$	1			$0.80 < \Phi$	0			Minor
2. Zone Size(mm)	Acceptable Qty																													
	A	B	C																											
$\Phi \leq 0.2$	Ignore																													
$0.20 < \Phi \leq 0.40$	3																													
$0.40 < \Phi \leq 0.60$	2																													
$0.60 < \Phi \leq 0.80$	1																													
$0.80 < \Phi$	0																													
	Circle shaped and dim edged defects																													





 OUTGOING QUALITY STANDARD		PAGE 3 OF 6					
TITLE: FUNCTIONAL TEST & INSPECTION CRITERIA		MDS Product					
4.2. Cosmetic Defect							
Item No	Items to be inspected	Inspection Standard			Classification of defects		
4.2.2	Line defect Black line, White line, Foreign material under polarizer,	Size(mm)		Acceptable Qty		Minor	
		L(Length)	W(Width)	Zone			
				A	B		C
		Ignore	$W \leq 0.02$	Ignore			Ignore
		$L \leq 3.0$	$0.02 < W \leq 0.03$	2			
		$L \leq 2.0$	$0.03 < W \leq 0.05$	1			
	$0.05 < W$	Define as spot defect					
4.2.3	Polarizer scratch	If the Polarizer scratch can be seen after mobile phone cover assembling or in the operating condition, judge by the line defect of 4.2.2. If the Polarizer scratch can be seen only in non-operating condition or some special angle, judge by the following.			Minor		
		Size(mm)		Acceptable Qty			
		L(Length)	W(Width)	Zone			
				A		B	C
		Ignore	$W \leq 0.03$	Ignore		Ignore	
		$5.0 < L \leq 10.0$	$0.03 < W \leq 0.05$	2			
$L \leq 5.0$	$0.05 < W \leq 0.08$	1					
	$0.08 < W$	0					
4.2.4	Polarize Air bubble	Air bubbles between glass & polarizer			Minor		
		2. Zone Size(mm)	Acceptable Qty				
			A	B		C	
		$\Phi \leq 0.2$	Ignore			Ignore	
		$0.20 < \Phi \leq 0.30$	2				
$0.30 < \Phi \leq 0.50$	1						
$0.50 < \Phi$	0						



	OUTGOING QUALITY STANDARD	PAGE 4 OF 6
---	---------------------------	-------------

TITLE: FUNCTIONAL TEST & INSPECTION CRITERIA

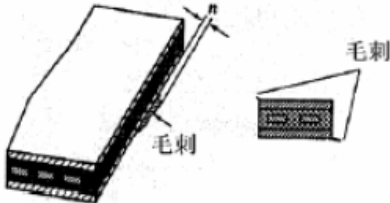
4.2.5	Foreign material on TP film	<p>The line can be seen after mobile phone in the operating condition:</p> <table border="1"> <thead> <tr> <th colspan="2">size(mm)</th> <th colspan="3">Acceptable Qty</th> </tr> <tr> <th rowspan="2">L(Length)</th> <th rowspan="2">W(Width)</th> <th colspan="3">zone</th> </tr> <tr> <th>A</th> <th>B</th> <th>C</th> </tr> </thead> <tbody> <tr> <td>Ignore</td> <td>$W \leq 0.03$</td> <td colspan="2">Ignore</td> <td rowspan="3">Ignore</td> </tr> <tr> <td>$L \leq 5.0$</td> <td>$0.03 < W \leq 0.05$</td> <td colspan="2">3</td> </tr> <tr> <td></td> <td>$0.05 < W$</td> <td colspan="2">Define as spot defect</td> </tr> </tbody> </table>	size(mm)		Acceptable Qty			L(Length)	W(Width)	zone			A	B	C	Ignore	$W \leq 0.03$	Ignore		Ignore	$L \leq 5.0$	$0.03 < W \leq 0.05$	3			$0.05 < W$	Define as spot defect		Minor				
size(mm)		Acceptable Qty																															
L(Length)	W(Width)	zone																															
		A	B	C																													
Ignore	$W \leq 0.03$	Ignore		Ignore																													
$L \leq 5.0$	$0.03 < W \leq 0.05$	3																															
	$0.05 < W$	Define as spot defect																															
	Dim Spots Circle shaped and dim edged defects	<table border="1"> <thead> <tr> <th rowspan="2">2. Zone Size(mm)</th> <th colspan="3">Acceptable Qty</th> </tr> <tr> <th>A</th> <th>B</th> <th>C</th> </tr> </thead> <tbody> <tr> <td>$\Phi \leq 0.2$</td> <td colspan="2">Ignore</td> <td rowspan="4">Ignore</td> </tr> <tr> <td>$0.20 < \Phi \leq 0.40$</td> <td colspan="2">2</td> </tr> <tr> <td>$0.40 < \Phi \leq 0.60$</td> <td colspan="2">1</td> </tr> <tr> <td>$0.60 < \Phi$</td> <td colspan="2">0</td> </tr> </tbody> </table>	2. Zone Size(mm)	Acceptable Qty			A	B	C	$\Phi \leq 0.2$	Ignore		Ignore	$0.20 < \Phi \leq 0.40$	2		$0.40 < \Phi \leq 0.60$	1		$0.60 < \Phi$	0		Minor										
2. Zone Size(mm)	Acceptable Qty																																
	A	B	C																														
$\Phi \leq 0.2$	Ignore		Ignore																														
$0.20 < \Phi \leq 0.40$	2																																
$0.40 < \Phi \leq 0.60$	1																																
$0.60 < \Phi$	0																																
4.2.6	Dim line defect Polarizer scratch TP film scratch	<table border="1"> <thead> <tr> <th colspan="2">Size(mm)</th> <th colspan="3">Acceptable Qty</th> </tr> <tr> <th rowspan="2">L(Length)</th> <th rowspan="2">W(Width)</th> <th colspan="3">Zone</th> </tr> <tr> <th>A</th> <th>B</th> <th>C</th> </tr> </thead> <tbody> <tr> <td>Ignore</td> <td>$W \leq 0.03$</td> <td colspan="2">Ignore</td> <td rowspan="4">Ignore</td> </tr> <tr> <td>$5.0 < L \leq 10.0$</td> <td>$0.03 < W \leq 0.05$</td> <td colspan="2">2</td> </tr> <tr> <td>$L \leq 5.0$</td> <td>$0.05 < W \leq 0.08$</td> <td colspan="2">1</td> </tr> <tr> <td></td> <td>$0.08 < W$</td> <td colspan="2">0</td> </tr> </tbody> </table>	Size(mm)		Acceptable Qty			L(Length)	W(Width)	Zone			A	B	C	Ignore	$W \leq 0.03$	Ignore		Ignore	$5.0 < L \leq 10.0$	$0.03 < W \leq 0.05$	2		$L \leq 5.0$	$0.05 < W \leq 0.08$	1			$0.08 < W$	0		Minor
Size(mm)		Acceptable Qty																															
L(Length)	W(Width)	Zone																															
		A	B	C																													
Ignore	$W \leq 0.03$	Ignore		Ignore																													
$5.0 < L \leq 10.0$	$0.03 < W \leq 0.05$	2																															
$L \leq 5.0$	$0.05 < W \leq 0.08$	1																															
	$0.08 < W$	0																															

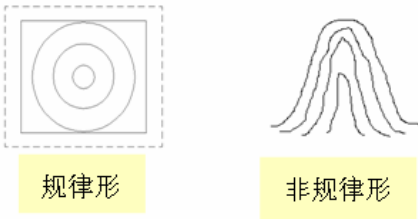
	<p>OUTGOING QUALITY STANDARD</p>	<p>PAGE 5 OF 6</p>
<p>TITLE: FUNCTIONAL TEST & INSPECTION CRITERIA</p>		
<p>4.2.7 TP Defect</p>	<p>1、 Pattern font: Pattern fonts are clear and symmetrical, pattern fonts filter lightly are allowed; The font line is not allow to thinner or thicker than 1/3of normal size, and swing is not more than 0.1mm. the line is smooth and not broken.</p>  <p>图案字体 Pattern font</p> <p>2、 The wing forward in the side of Visual Area: The length of wing forward inside of the Visual Area: $n \leq 0.2\text{mm}$; Not excess 3 point, and the distance $D \geq 20\text{mm}$.</p>  <p>3、 Film impression:With operation, must be invisibility.</p> <p>4、 Touch panel knob: if writing function normally,it could be allowed.</p>  <p>TP鼓 TP knob</p> <p>5、 Newton ring Without operation, the color circle of Regularity or Non-regularity from the normal or slope angle of view.</p> <p>1、 Regularity: The area of the newton ring is less than 1/3 area of the touch panel; and no character affected and line distorted after touch panel lightening. It's ok.</p> <p>2、 Non-regularity : The area of the Newton ring is less than the 1/2 area of touch panel with lightening. And no character affected and line</p> 	<p>Minor</p>

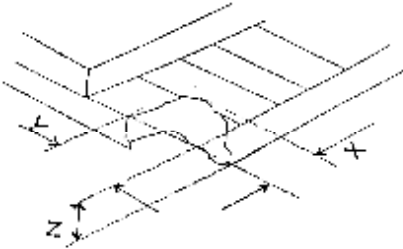
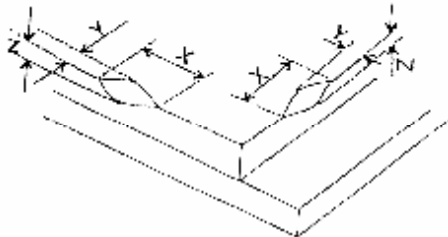
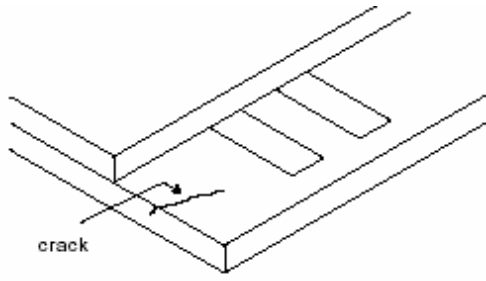
OUTGOING QUALITY STANDARD		PAGE 6 OF 6							
TITLE:FUNCTIONAL TEST & INSPECTION CRITERIA		MDS Product							
4.3. Cosmetic Defect									
Item No	Items to be inspected	Inspection Standard	Classification of defects						
4.3.5	Glass defect	(i) Chips on corner  <table border="1" data-bbox="475 817 1101 913"> <thead> <tr> <th>X</th> <th>Y</th> <th>Z</th> </tr> </thead> <tbody> <tr> <td>≤2.0</td> <td>≤S</td> <td>Disregard</td> </tr> </tbody> </table> Notes: S=contact pad length Chips on the corner of terminal shall not be allowed to extend into the ITO pad or expose perimeter seal.	X	Y	Z	≤2.0	≤S	Disregard	Minor
		X	Y	Z					
		≤2.0	≤S	Disregard					
(ii) Usual surface cracks  <table border="1" data-bbox="454 1344 1125 1440"> <thead> <tr> <th>X</th> <th>Y</th> <th>Z</th> </tr> </thead> <tbody> <tr> <td>≤3.0</td> <td><Inner border line of the seal</td> <td>Disregard</td> </tr> </tbody> </table>	X	Y	Z	≤3.0	<Inner border line of the seal	Disregard	Minor		
X	Y	Z							
≤3.0	<Inner border line of the seal	Disregard							
(iii) Crack Cracks tend to break are not allowed. 	Major								
4.3.6	Parts alignment	1) Not allow IC and FPC/heat-seal lead width is more than 50% beyond lead pattern. 2) Not allow chip or solder component is off center more than 50% of the pad outline.	Minor						
4.3.7	SMT	According to the <Acceptability of electronic assemblies> IPC-A-610C class 2 standard. Component missing or function defect are Major defect, the others are Minor defect.							

■ PRECAUTIONS FOR USING LCD MODULES

Handing Precautions

(1) The display panel is made of glass and polarizer. As glass is fragile. It tends to become or chipped during handling especially on the edges. Please avoid dropping or jarring. Do not subject it to a mechanical shock by dropping it or impact.

(2) If the display panel is damaged and the liquid crystal substance leaks out, be sure not to get any in your mouth. If the substance contacts your skin or clothes, wash it off using soap and water.

(3) Do not apply excessive force to the display surface or the adjoining areas since this may cause the color tone to vary. Do not touch the display with bare hands. This will stain the display area and degraded insulation between terminals (some cosmetics are determined to the polarizer).

(4) The polarizer covering the display surface of the LCD module is soft and easily scratched. Handle this polarizer carefully. Do not touch, push or rub the exposed polarizers with anything harder than an HB pencil lead (glass, tweezers, etc.). Do not put or attach anything on the display area to avoid leaving marks on. Condensation on the surface and contact with terminals due to cold will damage, stain or dirty the polarizer. After products are tested at low temperature they must be warmed up in a container before coming is contacting with room temperature air.

(5) If the display surface becomes contaminated, breathe on the surface and gently wipe it with a soft dry cloth. If it is heavily contaminated, moisten cloth with one of the following solvents

- Isopropyl alcohol
- Ethyl alcohol

Do not scrub hard to avoid damaging the display surface.

(6) Solvents other than those above-mentioned may damage the polarizer. Especially, do not use the following.

- Water
- Ketone
- Aromatic solvents

Wipe off saliva or water drops immediately, contact with water over a long period of time may cause deformation or color fading. Avoid contacting oil and fats.

(7) Exercise care to minimize corrosion of the electrode. Corrosion of the electrodes is accelerated by water droplets, moisture condensation or a current flow in a high-humidity environment.

(8) Install the LCD Module by using the mounting holes. When mounting the LCD module make sure it is free of twisting, warping and distortion. In particular, do not forcibly pull or bend the I/O cable or the backlight cable.

(9) Do not attempt to disassemble or process the LCD module.

(10) NC terminal should be open. Do not connect anything.

(11) If the logic circuit power is off, do not apply the input signals.

(12) Electro-Static Discharge Control, Since this module uses a CMOS LSI, the same careful attention should be paid to electrostatic discharge as for an ordinary CMOS IC. To prevent destruction of the elements by static electricity, be careful to maintain an optimum work environment.

- Before remove LCM from its packing case or incorporating it into a set, be sure the module and your body have the same electric potential. Be sure to ground the body when handling the LCD modules.

- Tools required for assembling, such as soldering irons, must be properly grounded. make certain the AC power source for the soldering iron does not leak. When using an electric screwdriver to attach LCM, the screwdriver should be of ground potentiality to minimize as much as possible any transmission of electromagnetic waves produced sparks coming from the commutator of the motor.

- To reduce the amount of static electricity generated, do not conduct assembling and other work under dry conditions. To reduce the generation of static electricity be careful that the air in the work is not too dried. A relative humidity of 50%-60% is recommended. As far as possible make the electric potential of your work clothes and that of the work bench the ground potential

- The LCD module is coated with a film to protect the display surface. Exercise care when peeling off this protective film since static electricity may be generated

(13) Since LCM has been assembled and adjusted with a high degree of precision, avoid applying excessive shocks to the module or making any alterations or modifications to it.

- Do not alter, modify or change the shape of the tab on the metal frame.

- Do not make extra holes on the printed circuit board, modify its shape or change the positions of components to be attached.

- Do not damage or modify the pattern writing on the printed circuit board.

- Absolutely do not modify the zebra rubber strip (conductive rubber) or heat seal connector.

- Except for soldering the interface, do not make any alterations or modifications with a soldering iron.

- Do not drop, bend or twist LCM.

Handling precaution for LCM

LCM is easy to be damaged. Please note below and be careful for handling.

Correct handling:



As above picture, please handle with anti-static gloves around LCM edges.

Incorrect handling:



Please don't touch IC directly.

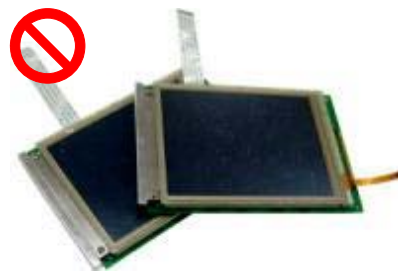

Please don't stack LCM.



Please don't hold the surface of panel.

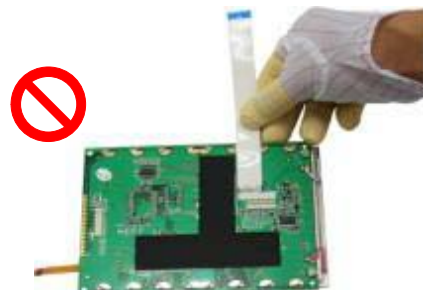

Please don't stretch interface of output, such as FPC cable.



Please don't hold the surface of IC.



Please don't operate with sharp stick such as pens.

Storage Precautions

When storing the LCD modules, the following precaution is necessary.

- (1) Store them in a sealed polyethylene bag. If properly sealed, there is no need for the dessicant.
- (2) Store them in a dark place. Do not expose to sunlight or fluorescent light, keep the temperature between 0°C and 35°C, and keep the relative humidity between 40%RH and 60%RH.
- (3) The polarizer surface should not come in contact with any other objects. (We advise you to store them in the anti-static electricity container in which they were shipped.)

Others

Liquid crystals solidify under low temperature (below the storage temperature range) leading to defective orientation or the generation of air bubbles (black or white). Air bubbles may also be generated if the module is subject to a low temperature.

If the LCD modules have been operating for a long time showing the same display patterns, the display patterns may remain on the screen as ghost images and a slight contrast irregularity may also appear. A normal operating status can be regained by suspending use for some time. It should be noted that this phenomenon does not adversely affect performance reliability.

To minimize the performance degradation of the LCD modules resulting from destruction caused by static electricity etc., exercise care to avoid holding the following sections when handling the modules.

- Exposed area of the printed circuit board.
- Terminal electrode sections.

■ USING LCD MODULES

Installing LCD Modules

The hole in the printed circuit board is used to fix LCM as shown in the picture below. Attend to the following items when installing the LCM.

- (1) Cover the surface with a transparent protective plate to protect the polarizer and LC cell.

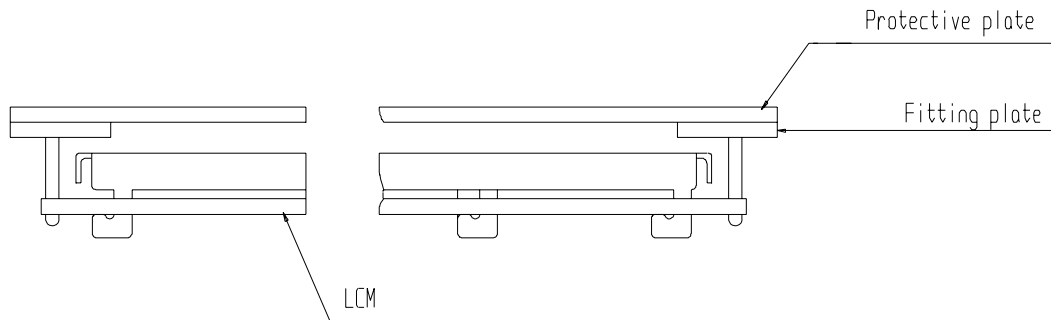

- (2) When assembling the LCM into other equipment, the spacer to the bit between the LCM and the fitting plate should have enough height to avoid causing stress to the module surface, refer to the individual specifications for measurements. The measurement tolerance should be ± 0.1 mm.

Precaution for assemble the module with BTB connector:

Please note the position of the male and female connector position, don't assemble or assemble like the method which the following picture shows

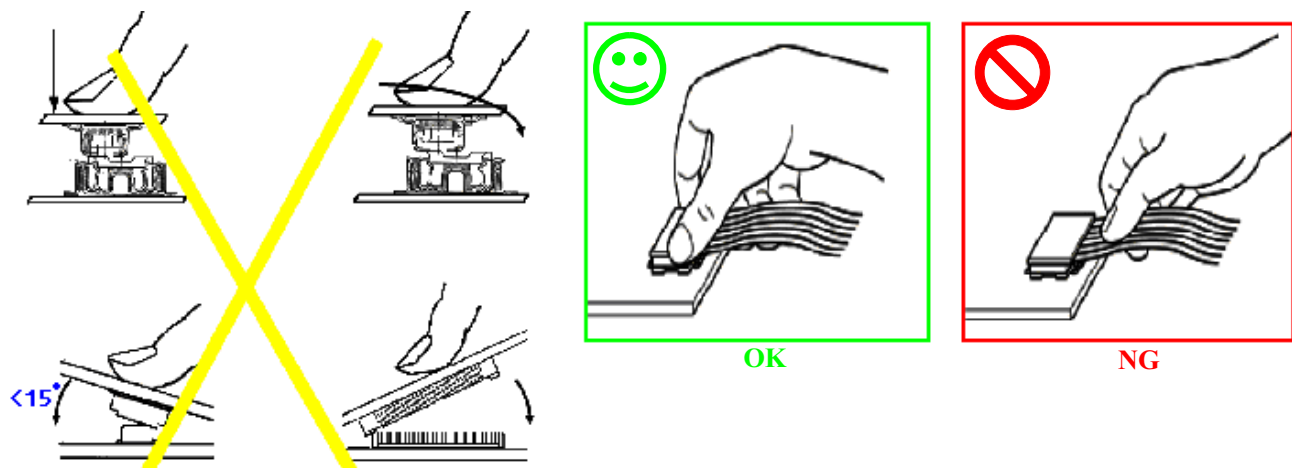

Precaution for soldering the LCM

	Manual soldering	Machine drag soldering	Machine press soldering
No ROHS product	290°C ~350°C. Time : 3-5S.	330°C ~350°C. Speed : 4-8 mm/s.	300°C ~330°C. Time : 3-6S. Press: 0.8~1.2Mpa
ROHS product	340°C ~370°C. Time : 3-5S.	350°C ~370°C. Time : 4-8 mm/s.	330°C ~360°C. Time : 3-6S. Press: 0.8~1.2Mpa

(1) If soldering flux is used, be sure to remove any remaining flux after finishing to soldering operation. (This does not apply in the case of a non-halogen type of flux.) It is recommended that you protect the LCD surface with a cover during soldering to prevent any damage due to flux spatters.

(2) When soldering the electroluminescent panel and PC board, the panel and board should not be detached more than three times. This maximum number is determined by the temperature and time conditions mentioned above, though there may be some variance depending on the temperature of the soldering iron.

(3) When remove the electroluminescent panel from the PC board, be sure the solder has completely melted, the soldered pad on the PC board could be damaged.

Precautions for Operation

(1) Viewing angle varies with the change of liquid crystal driving voltage (VLCD). Adjust VLCD to show the best contrast.

(2) It is an indispensable condition to drive LCD's within the specified voltage limit since the higher voltage then the limit cause the shorter LCD life. An electrochemical reaction due to direct current causes LCD's undesirable deterioration, so that the use of direct current drive should be avoided.

(3) Response time will be extremely delayed at lower temperature than the operating temperature range and on the other hand at higher temperature LCD's show dark color in them. However those phenomena do not mean malfunction or out of order with LCD's, Which will come back in the specified operating temperature.

(4) If the display area is pushed hard during operation, the display will become abnormal. However, it will return to normal if it is turned off and then back on.

(5) A slight dew depositing on terminals is a cause for electro-chemical reaction resulting in terminal open circuit. Usage under the maximum operating temperature, 50%RH or less is required.

(6) Input logic voltage before apply analog high voltage such as LCD driving voltage when power on. Remove analog high voltage before logic voltage when power off the module. Input each signal after the positive/negative voltage becomes stable.

(7) Please keep the temperature within specified range for use and storage. Polarization degradation, bubble generation or polarizer peel-off may occur with high temperature and high humidity.

Safety

(1) It is recommended to crush damaged or unnecessary LCDs into pieces and wash them off with solvents such as acetone and ethanol, which should later be burned.

(2) If any liquid leaks out of a damaged glass cell and comes in contact with the hands, wash off thoroughly with soap and water.

Limited Warranty

Unless agreed between Multi-Inno and customer, Multi-Inno will replace or repair any of its LCD modules which are found to be functionally defective when inspected in accordance with Multi-Inno LCD acceptance standards (copies available upon request) for a period of one year from date of production. Cosmetic/visual defects must be returned to Multi-Inno within 90 days of shipment. Confirmation of such date shall be based on data code on product. The warranty liability of Multi-Inno limited to repair and/or replacement on the terms set forth above. Multi-Inno will not be responsible for any subsequent or consequential events.

Return LCM under warranty

No warranty can be granted if the precautions stated above have been disregarded. The typical examples of violations are :

- Broken LCD glass.
- PCB eyelet is damaged or modified.
- PCB conductors damaged.
- Circuit modified in any way, including addition of components.
- PCB tampered with by grinding, engraving or painting varnish.
- Soldering to or modifying the bezel in any manner.



Module repairs will be invoiced to the customer upon mutual agreement. Modules must be returned with sufficient description of the failures or defects. Any connectors or cable installed by the customer must be removed completely without damaging the PCB eyelet, conductors and terminals.

■ PRIOR CONSULT MATTER

- 1.①For Multi-Inno standard products, we keep the right to change material, process ... for improving the product property without notice on our customer.
②For OEM products, if any change needed which may affect the product property, we will consult with our customer in advance.
2. If you have special requirement about reliability condition, please let us know before you start the test on our samples.