



# FORMIKE ELECTRONIC CO.,LTD

## PRDUCT SPECIFICATON

TFT LCD MODULE

MODEL : KWH040GM05-F02

【   】 Preliminary Specification

【 ♦  】 Finally Specification

CUSTOMER'S APPROVAL	
SIGNATURE:	DATE:

APPROVED BY	PM REVIEWD	PD REVIEWD	PREPARED BY
Wayne	Li tong	Zhengjinrong	Jully

**Prepared By :**

FORMIKE ELECTRONIC CO.,LTD

Address : A909, Huaying Building, 97 Nanshang Road,Nanshan District, Shenzhen, China.518054

TEL:(86) 755 88306921,88306931 FAX:(86) 755 88304615

Http:// www.wandisplay.com

- This specification is subject to change withouth notice.Please contact FORMIKE or it's representative before designing your product based on this specification.

Issued Date: Feb-25-2008



**1. GENERAL DESCRIPTION .....4**

**2. FEATURES.....4**

**3. MECHANICAL SPECIFICATION .....4**

**4. MECHANICALDIMENSION.....5**

**5. MAXIMUM RATINGS .....6**

**6. ELECTRICAL CHARACTERISTICS .....7**

6.1. TFT LCD Characetristic .....7

6.2. Backlight Characteristic.....7

**7. MODULE FUNCTION DESCRIPTION ..... 8**

7.1. PIN Description .....8

7.2. Timing characteristics ..... 9

**8. TOUCH PANEL ..... 10**

8.1. Electrical Characteristics..... 11

**9. ELECTRO-OPTICAL CHARACTERISTICS..... 13**

**10. RELIABILITY ..... 14**

10.1. TESTS..... 15

10.2. Color Performance ..... 16

**11. INSPECTION CRITERIA ..... 17**

11.1. Inspection Conditions ..... 17

11.2. Light Method..... 18

11.3. Classification Of Defects ..... 19

11.4. Sampling & Acceptable Quality Level..... 20

11.5. Definition Of Inspection Area..... 21

11.6. Items and Criteria ..... 22

**12. ROHS COMPLIANT WARRANTY ..... 23**



<b>13. PRECAUTIONS FOR USE .....</b>	<b>23</b>
13.1. Safety .....	23
13.2. Storage Conditions .....	23
13.3. Installing LCD Module .....	23
13.4. Precautions For Operation .....	24
13.5. Handling Precautions .....	24
13.6. Warranty.....	24

Formike Electronic Co., Ltd.



## 1. GENERAL DESCRIPTION

KWH040GM05-F02 is a Transmissive type color active matrix liquid crystal display (LCD), which uses amorphous thin film transistor (TFT) as switching devices. This product is composed of a TFT LCD panel, driver ICs, FPC, touch panel and a backlight unit. The following table described the features of KWH040GM05-F02

## 2. FEATURES

Display Mode	Transmissive Type
	TFT LCD, Normally white
Display Format	RGB Strip type
Color	16.7M color
Interface	RGB data bus, 24 bit parallel data
Viewing Direction	6 O'clock
Backlight type / color	LED / White

## 3. MECHANICAL SPECIFICATION

Item	Specifications	Unit
Dimensional outline	98.3(W)×62.6(H)×6.15(D)*	mm
Resolution	480×3(R,G,B)×272	dot
Active area	87.84(W)×49.776(H)	mm
Pixel pitch	0.183(W)×0.183(H)	mm

\* Exclude FPC



# 4. MECHANICAL DIMENSION

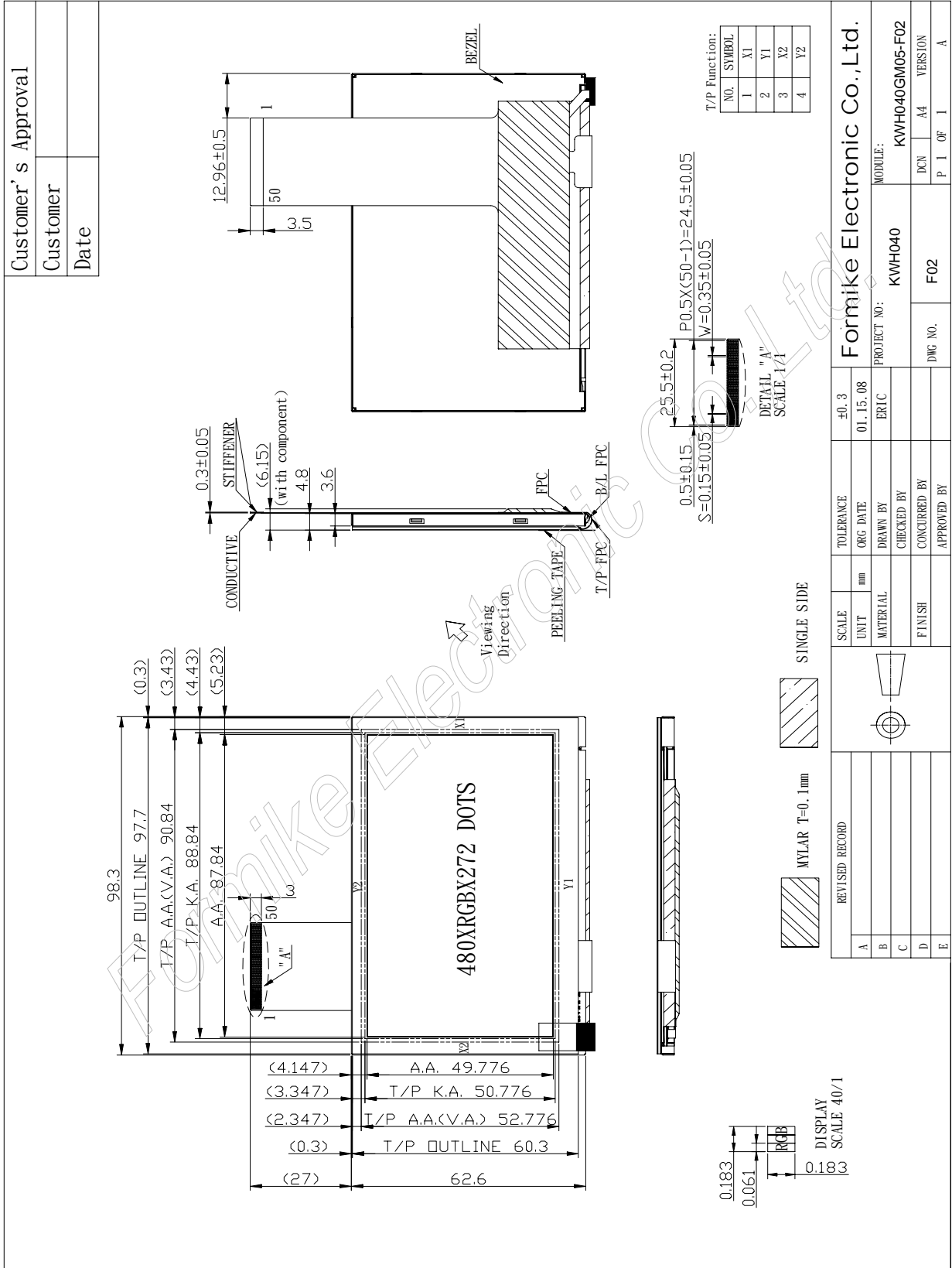



## 5. MAXIMUM RATINGS

ITEM	SYMBOL	MIN.	MAX.	UNIT
Power Supply Voltage	VCC	-0.3	+6	V
Power Supply Voltage	Vi	-0.3	VCC+0.3	V
Operation Temperature	T <sub>op</sub>	-20	70	°C
Storage Temperature	T <sub>stg</sub>	-30	80	°C
Singal LED forward current	I <sub>F</sub>	-	30	mA
Singal LED pulse forward current	I <sub>FP</sub>	-	100	mA
Singal LED reverse current	V <sub>R</sub>	-	5	V
Humidity	-	-	90	%RH

Note:

- All of voltage listed above are with respectve to GND=VSS=0V.
- Device is subject to be damaged permanently if stresses beyond those absolute maximum ratings listed above.
- T<sub>A</sub> ≤ 40°C Without dewing.



## 6. ELECTRICAL CHARACTERISTICS

### 6.1.TFT LCD Characetristic

Typical operating conditions

(GND=AVSS=0V)

Item	Symbol	Min.	Typ.	Max.	Unit	Note
Power supply	VCC	3.0	3.3	3.6	V	
Current	ICC	-	40	-	mA	
Driver Input signal voltage	H	$V_{TH}$	$0.7*VCC$	-	VCC	V
	L	$V_{TL}$	0	-	$0.3*VCC$	V

### 6.2.Backlight Characteristic

Item	Symbol	Values			Unit	Remark
		Min.	Typ.	Max.		
Power Consumption	$P_{LED}$	-	580	-	mW	
LED Current	$I_L$	-	20	-	mA	
LED Voltage	$V_L$	21.7	23.1	25.2	V	

**Note: GP suggest using constant current driving this backlight unit.**



## 7. MODULE FUNCTION DESCRIPTION

### 7.1.PIN Description

Pin	Symbol	Description	Remark
1	VSS	Ground	
2	VSS	Ground	
3	VCC	Power supply	
4	VCC	Power supply	
5	R0	Red data bit 0	
6	R1	Red data bit 1	
7	R2	Red data bit 2	
8	R3	Red data bit 3	
9	R4	Red data bit 4	
10	R5	Red data bit 5	
11	R6	Red data bit 6	
12	R7	Red data bit 7	
13	G0	Green data bit 0	
14	G1	Green data bit 1	
15	G2	Green data bit 2	
16	G3	Green data bit 3	
17	G4	Green data bit 4	
18	G5	Green data bit 5	
19	G6	Green data bit 6	
20	G7	Green data bit 7	
21	B0	Blue data bit 0	
22	B1	Blue data bit 1	
23	B2	Blue data bit 2	
24	B3	Blue data bit 3	
25	B4	Blue data bit 4	
26	B5	Blue data bit 5	
27	B6	Blue data bit 6	
28	B7	Blue data bit 7	
29	VSS	Ground	





30	DCLK	Dot data clock input	
31	DISP	Display on/off control	Note1
32	HSYNC	Horizontal sync input	
33	VSNC	Vertical sync input	
34	DE	Data enable control	Note2
35	U/D	Shift up or down control	Note3
36	L/R	Shift left or right control	Note4
37	VSS	Ground	
38	VSS	Ground	
39	X1	T/P right	
40	Y1	T/P bottom	
41	X2	T/P left	
42	Y2	T/P up	
43	VSS	Ground	
44	VSS	Ground	
45	VSS	Ground	
46	VLED-	LED ground	
47	VLED+	LED power	
48	VSS	Ground	
49	VSS	Ground	
50	VSS	Ground	

**Note:**

1. DISP set "High", input data are valid. DISP set "Low", input data are invalid .
2. DE is "High",data can be access. DE is "Low",data can not be access..
3. U/D set "High" \_scan from UP to Down. U/D set "Low" \_Down to UP.
4. L/R set "High" scan from Left to Right. L/R set "Low" scan form Right to Left



## 7.2.Timing characteristics

### 7.2.1.Timing Chart.

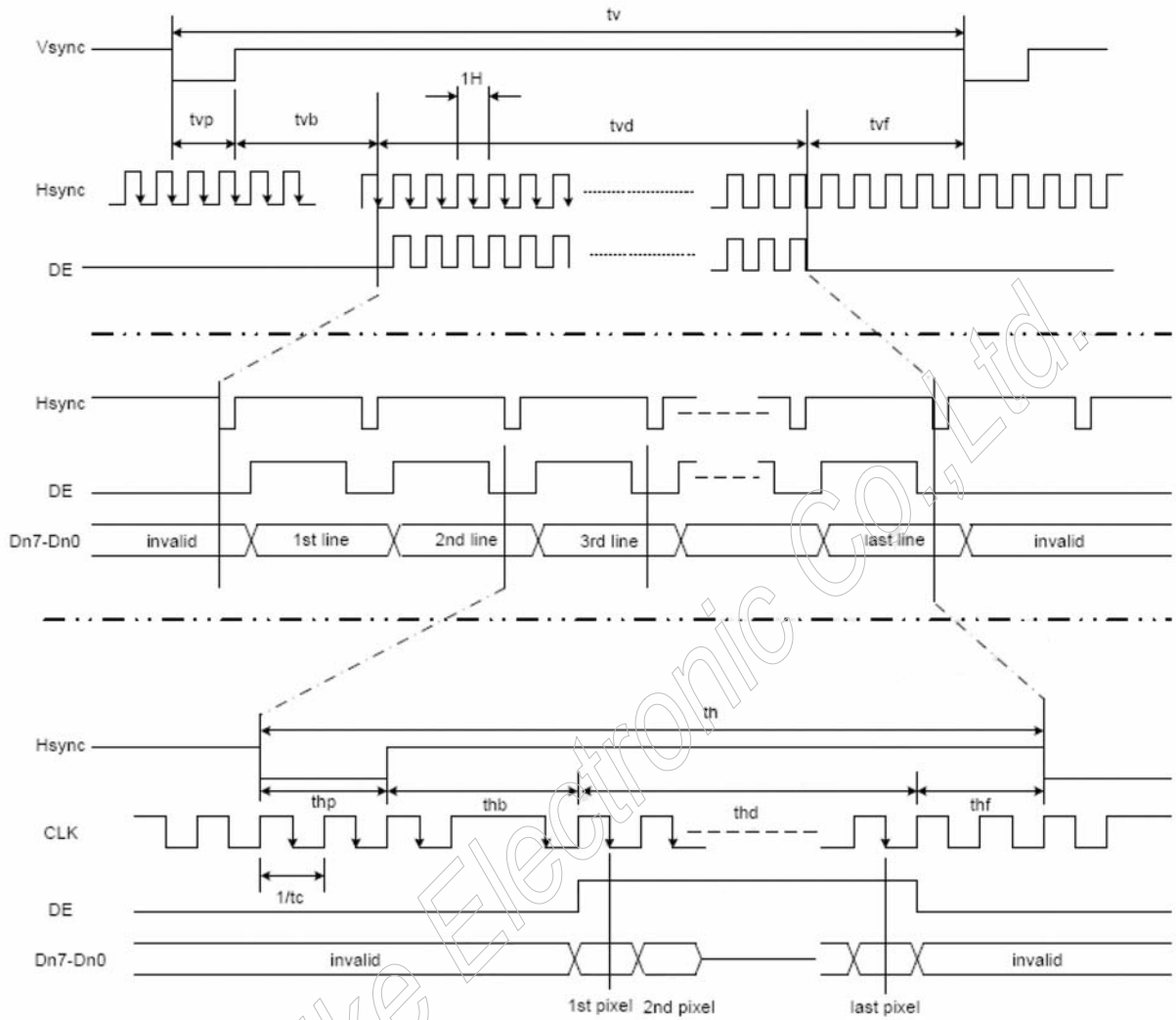



## 7.2.2.Timing Specification

Item		Symbol	Min.	Typ.	Max.	Unit
CLK/Hsync /Vsync	CLK cycle	$t_{CLK}$	-	9	15	MHz
	Hsync cycle	$1/th$	-	17.14	-	KHz
	Vsync cycle	$1/tv$	-	59.94	-	Hz
Horizontal cycle	Horizontal cycle	th		525		CLK
	Horizontal display period	thd		480		CLK
	Horizontal front porch	thf	2	-	-	CLK
	Horizontal pulse width	thp	2	41	-	CLK
	Horizontal back porch	thb	2	2	-	CLK
Vertical cycle	Vertical cycle	tv	-	286	-	H
	Vertical display period	tvd	-	272	-	H
	Vertical front porch	tvf	1	2	-	H
	Vertical pulse width	tvp	1	10	-	H
	Vertical back porch	tvb	1	2	-	H



7.2.3.Color data Assignment

COLOR	INPUT DATA	R DATA								G DATA								B DATA							
		R7	R6	R5	R4	R3	R2	R1	R0	G7	G6	G5	G4	G3	G2	G1	G0	B7	B6	B5	B4	B3	B2	B1	B0
		MSB				LSB				MSB				LSB				MSB				LSB			
BASIC COLOR	BLACK	0	0	0	0	0	0	0	0	0	0	0	0	0	0	0	0	0	0	0	0	0	0	0	0
	RED(255)	1	1	1	1	1	1	1	1	0	0	0	0	0	0	0	0	0	0	0	0	0	0	0	0
	GREEN(255)	0	0	0	0	0	0	0	0	1	1	1	1	1	1	1	1	0	0	0	0	0	0	0	0
	BLUE(255)	0	0	0	0	0	0	0	0	0	0	0	0	0	0	0	0	1	1	1	1	1	1	1	1
	CYAN	0	0	0	0	0	0	0	0	1	1	1	1	1	1	1	1	1	1	1	1	1	1	1	1
	MAGENTA	1	1	1	1	1	1	1	1	0	0	0	0	0	0	0	0	1	1	1	1	1	1	1	1
	YELLOW	1	1	1	1	1	1	1	1	1	1	1	1	1	1	1	1	0	0	0	0	0	0	0	0
	WHITE	1	1	1	1	1	1	1	1	1	1	1	1	1	1	1	1	1	1	1	1	1	1	1	1
RED	RED(0)	0	0	0	0	0	0	0	0	0	0	0	0	0	0	0	0	0	0	0	0	0	0	0	0
	RED(1)	0	0	0	0	0	0	0	1	0	0	0	0	0	0	0	0	0	0	0	0	0	0	0	0
	RED(2)	0	0	0	0	0	0	1	0	0	0	0	0	0	0	0	0	0	0	0	0	0	0	0	0
	RED(254)	1	1	1	1	1	1	1	0	0	0	0	0	0	0	0	0	0	0	0	0	0	0	0	0
	RED(255)	1	1	1	1	1	1	1	1	0	0	0	0	0	0	0	0	0	0	0	0	0	0	0	0
GREEN	GREEN(0)	0	0	0	0	0	0	0	0	0	0	0	0	0	0	0	0	0	0	0	0	0	0	0	0
	GREEN(1)	0	0	0	0	0	0	0	0	0	0	0	0	0	0	1	0	0	0	0	0	0	0	0	0
	GREEN(2)	0	0	0	0	0	0	0	0	0	0	0	0	0	1	0	0	0	0	0	0	0	0	0	
	GREEN(254)	0	0	0	0	0	0	0	0	1	1	1	1	1	1	0	0	0	0	0	0	0	0	0	0
	GREEN(255)	0	0	0	0	0	0	0	0	1	1	1	1	1	1	1	0	0	0	0	0	0	0	0	
BLUE	BLUE(0)	0	0	0	0	0	0	0	0	0	0	0	0	0	0	0	0	0	0	0	0	0	0	0	0
	BLUE(1)	0	0	0	0	0	0	0	0	0	0	0	0	0	0	0	0	0	0	0	0	0	0	0	1
	BLUE(2)	0	0	0	0	0	0	0	0	0	0	0	0	0	0	0	0	0	0	0	0	0	0	1	0
	BLUE(254)	0	0	0	0	0	0	0	0	0	0	0	0	0	0	0	0	1	1	1	1	1	1	1	0
	BLUE(255)	0	0	0	0	0	0	0	0	0	0	0	0	0	0	0	0	1	1	1	1	1	1	1	1



## 8. TOUCH PANEL

### 8.1. Electrical Characteristics

Item	Min.	Typ.	Max.	Unit	Note
Linearity	-	-	1.5	%	
Resistance between terminals	500	-	1500	$\Omega$	X (Film side)
	200	-	900	$\Omega$	Y (Glass side)
Insulation resistance	20M	-	-	$\Omega$	
Operation voltage	-	-	5	V	
Response time	-	-	10	ms	
Transmittance	-	80	-	%	
Haze	4	8	12	%	



## 9. ELECTRO-OPTICAL CHARACTERISTICS

The following items are measured under stable conditions. The optical characteristics should be measured in dark room or equivalent state with the methods shown in Note 1.

Item	Symbol	Condition	Min	Typ	Max	Unit	Remark
Brightness(W/O T/P)			300	320	-	cd/m <sup>2</sup>	
Response time	$T_R+T_F$	$\Theta=0$	-	30	-	ms	Note 2
Contrast ratio (W/O T/P)	CR	At the center point of A.A.	300	350	-		Note 3
Color Chromaticity	White	$W_x$	$\Theta=0$	0.273	0.313	0.353	Note 4
		$W_y$		0.289	0.329	0.369	
Viewing Angle	Horizontal	$CR \geq 10$	100	120	-	Degree	Note 5
	Vertical		90	105	-		

$T_a=25\pm 2^\circ\text{C}$

Note:

Test equipment setup

After stabilizing and leaving the panel alone at a given temperature for 30 minutes, the measurement should be executed. Measurement should be executed in a stable, windless, and dark room. Optical specifications are measured by Topcon BM-5A with a viewing angle of  $2^\circ$  at a distance of 50cm and normal direction.

Definition of response time:  $T_R$  and  $T_F$

The figure below is the output signal of the photo detector.

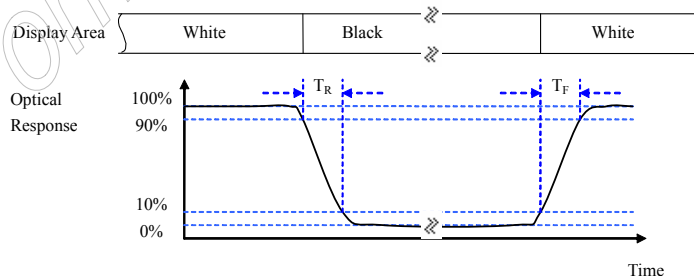



Definition of contrast ratio:

$$\text{Contrast ratio (CR)} = \frac{\text{Brightness measured when LCD is at "white state"}}{\text{Brightness measured when LCD is at "black state"}}$$

White  $V_i = V_{i50\%} \pm 1.5V$

Black  $V_i = V_{i50\%} \mu 2.0V$

" $\pm$ " means that the analog input signal swings in phase with VCOM signal.

" $\mu$ " means that the analog input signal swings out of phase with VCOM signal.

$V_{i50\%}$ : The analog input voltage when transmission is 50%.

The 100% transmission is defined as the transmission of LCD panel when all the input terminals of module are electrically opened.

Measured at the center area of the panel when all the input terminals of LCD panel are electrically opened.

5. Definition of viewing angle:

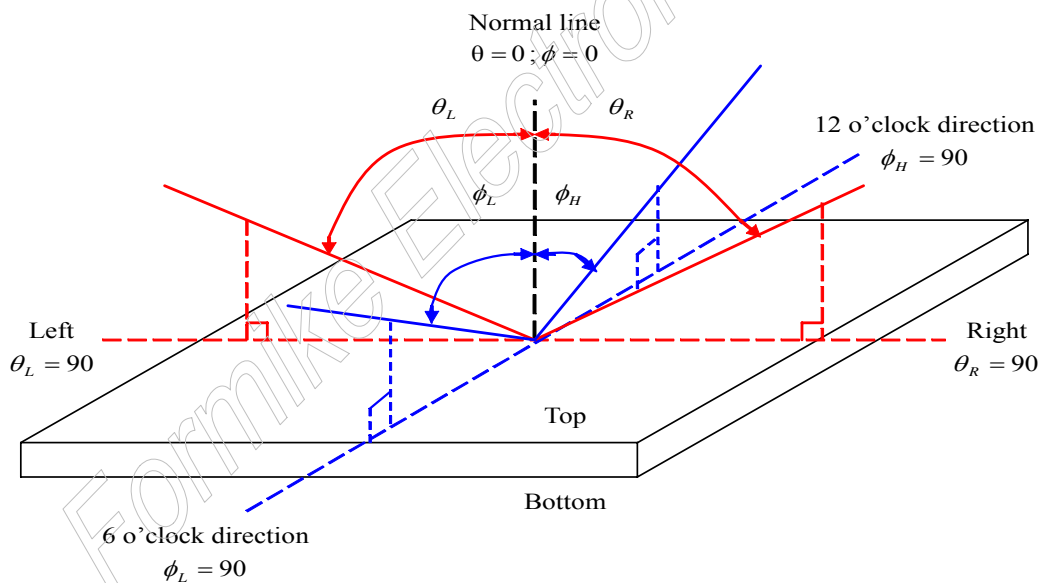



## 10.RELIABILITY

### 10.1.TESTS

NO.	ITEM	CONDITION	CRITERION
1	High Temperature Operating	70°C 240 hrs	◦ No Defect Of Operational Function In Room Temperature Are Allowable.
2	Low Temperature Operating	-20°C 240 hrs	
3	High Temperature/ Humidity Non-Operating	60°C ,90%RH ,240 hrs (No condensation)	
4	High Temperature Non-Operating	80°C 240 hrs	
5	Low Temperature Non-Operating	-30°C 240 hrs	
6	Temperature Shock Non-Operating	-30°C (30min) ↔ 80°C (30min) (5min) 100 CYCLES	
7	Electro-static Discharge	HBM : ±2kv	

Note 1: Test after 24 hours in room temperature.

Note 2: The sampling above is individually for each reliability testing condition.

Note 3: The color fading of polarizing filter should not care.

Note 4: All of the reliability testing chamber above, is using D.I. water.(Min value:1.0 MΩ -cm)

Note 5: In case of malfunction defect caused by ESD damage, if it would be recovered to normal state after resetting, it would be judged as a good part.

### 10.2.Color Performance

No.	ITEM	Criterion (initial)
1	Luminance	>50%
2	NTSC	>70%
3	Contrast Ratio	>50%





## 11.INSPECTION CRITERIA

### 11.1.Inspection Conditions

#### 11.1.1.Environmental conditions

The environmental conditions for inspection shall be as follows

Room temperature:  $23\pm 5^{\circ}\text{C}$

Humidity:  $50\pm 20\%\text{RH}$

#### 11.1.2.The external visual inspection

With a single  $1000\pm 200\text{lux}$  fluorescent lamp as the light source, the inspection was in the distance of 30cm or more from the LCD to the inspector's eyes.

### 11.2.Light Method

11.2.1.Environment lamp under  $1000\pm 200\text{ lux}$ , Viewing direction for inspection over 30 cm

11.2.2.The distance from eye to defect around 300mm, the distance from ND Filter to defect around 25~30mm

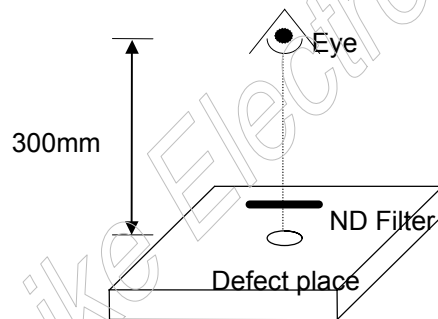

### 11.3.Classification Of Defects

#### 11.3.1.Major defect

A major defect refers to a defect that may substantially degrade usability for product applications.

#### 11.3.2.Minor defect

A minor defect refers to a defect which is not considered to be able substantially degrade the product application or a defect that deviates from existing standards almost unrelated to the effective use of the product or its operation.



Notes: If the LCD/LCM 's cosmetic and display performance do not specify in "inspection criterion", it should be based on these delivered samples.

### 11.4.Sampling & Acceptable Quality Level

Level II, MIL-STD-105E

	Major	Minor
Cosmetic	1.0 %	1.5 %
Electrical-display	0.4%	0.65 %

### 11.5.Definition Of Inspection Area

V.A: Viewing Area

A.A: Active Area

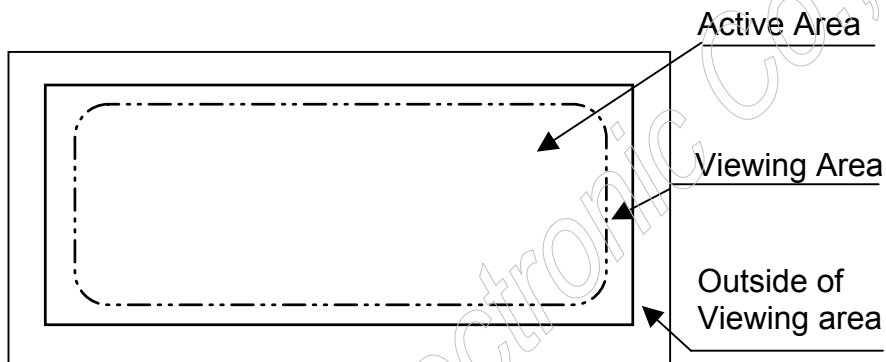



## 11.6.Items and Criteria

### 11.6.1.Visual inspection criterion in cosmetic

#### (1) Glass defect

No	Defect	Criteria	Remark
1	Dimension (Minor)	By engineering diagram	
2	Cracks (Major)	Extensive crack <b>【Reject】</b>	

#### (2) LCM appearance defect

No	Defect	Criteria	Remark	
1	Round type (Minor)	Spec.	Permissible Qty	1. $\phi = (L+W)/2$ , L: Length, W: Width 2. Disregard if out of A.A. 
		$\phi < 0.20\text{mm}$	Disregard	
		$0.20\text{mm} \leq \phi \leq 0.50\text{mm}$	5	
		$0.50\text{mm} < \phi$	0	
2	Line type (Minor)	Spec.	Permissible Qty	1. L: Length, W: Width 2. Disregard if out of A.A. 
		$W \leq 0.10\text{mm}$ and $L \leq 10\text{mm}$	Disregard	
		$L \leq 10\text{mm}$ and $0.10\text{mm} < W \leq 0.25\text{mm}$	4	
		$W > 0.25\text{mm}$ or $L > 10\text{mm}$	0	
3	Corner chip (Minor)	$X \leq 3.0\text{mm}$ , $Y \leq 3.0\text{mm}$ , $Z \leq T$ <b>【Disregard】</b>		
4	Edge chip (Minor)	$X \leq 3.0\text{mm}$ , $Y \leq 3.0\text{mm}$ , $Z \leq T$ <b>【Disregard】</b>		

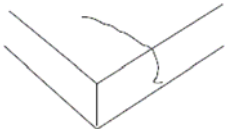
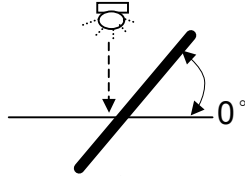

No	Defect	Criteria		Remark
5	Crack (Maior)	Not allowed		
6	Newton's ring (Minor)	Defect Spec.	Permissible Q'ty	Under day light 
		$\phi \leq 7\text{mm}$	Disregard	
		$\phi > 7\text{mm}$	0	

(3) FPC

No	Defect	Criteria		Remark
1	Copper peeling (Minor)	Copper peeling	<b>【Reject】</b>	

(4) Black tape

No	Defect	Criteria		Remark
1	Shift (Minor)	IC exposed	<b>【Reject】</b>	
2	No black tape (Minor)	No black tape	<b>【Reject】</b>	

(5) Silicon

No	Defect	Criteria		Remark
1	Amount of silicon (Minor)	ITO exposed	<b>【Reject】</b>	

(6) Bezel

No	Defect	Criteria		Remark
1	Oxidized spot (Minor)	Oxidized spot, rust	<b>【Reject】</b>	
2	Outline deformation (Minor)	By engineering diagram		
3	Greasiness (Minor)	Greasiness	<b>【Reject】</b>	



No	Defect	Criteria	Remark
4	Spots, round Type (Minor)	$H \leq$ By engineering diagram <b>【Disregard】</b>	H=Total height (thickness)
5	Plating (Minor)	Bubble, peeling <b>【Reject】</b>	

11.6.2. Visual inspection criterion in electrical display

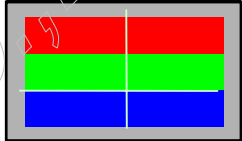
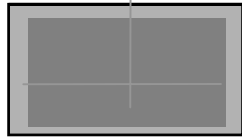
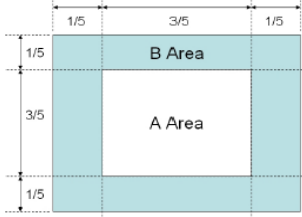
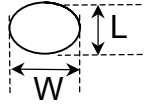
No	Defect	Criteria	Remark																				
1	No display (Major)	Not allowed																					
2	Missing line (Major)	Not allowed																					
3	Darker or lighter line (Major)	Not allowed																					
4	Weak line (Minor)	By limit sample																					
5	Bright / Dark point (Minor)	<table border="1"> <thead> <tr> <th></th> <th>A Area</th> <th>B Area</th> <th>Total</th> </tr> </thead> <tbody> <tr> <td>Bright point</td> <td>0</td> <td>1</td> <td>1</td> </tr> <tr> <td>Dark dot point</td> <td>1</td> <td>3</td> <td>3</td> </tr> <tr> <td>Bright +Dark point</td> <td>1</td> <td>3</td> <td>4</td> </tr> <tr> <td>Two adjacent dot</td> <td colspan="3">Not allowed</td> </tr> </tbody> </table>		A Area	B Area	Total	Bright point	0	1	1	Dark dot point	1	3	3	Bright +Dark point	1	3	4	Two adjacent dot	Not allowed			1. 1sub-pixel: 1R or 1G or 1B 2. Point defect area $\geq$ 1/2 sub pixel. 
			A Area	B Area	Total																		
		Bright point	0	1	1																		
		Dark dot point	1	3	3																		
		Bright +Dark point	1	3	4																		
Two adjacent dot	Not allowed																						
Round type (Minor)	<table border="1"> <thead> <tr> <th>Spec.</th> <th>Permissible Qty</th> </tr> </thead> <tbody> <tr> <td><math>\phi &lt; 0.20\text{mm}</math></td> <td>Disregard</td> </tr> <tr> <td><math>0.20\text{mm} \leq \phi \leq 0.50\text{mm}</math></td> <td>5</td> </tr> <tr> <td><math>0.50\text{mm} &lt; \phi</math></td> <td>0</td> </tr> </tbody> </table>	Spec.	Permissible Qty	$\phi < 0.20\text{mm}$	Disregard	$0.20\text{mm} \leq \phi \leq 0.50\text{mm}$	5	$0.50\text{mm} < \phi$	0	0. $\phi = (L+W)/2$ , L: Length, W: Width 2. Disregard if out of A.A. 													
Spec.	Permissible Qty																						
$\phi < 0.20\text{mm}$	Disregard																						
$0.20\text{mm} \leq \phi \leq 0.50\text{mm}$	5																						
$0.50\text{mm} < \phi$	0																						

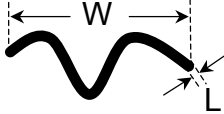

No	Defect	Criteria		Remark
7	Line type  (Minor)	Spec.	Permissible Qty	1. L: Length, W: Width 2. Disregard if out of A.A.  
		$W \leq 0.10\text{mm}$ and $L \leq 10\text{mm}$	Disregard	
		$L \leq 10\text{mm}$ and $0.10\text{mm} < W \leq 0.25\text{mm}$	4	
		$W > 0.25\text{mm}$ or $L > 10\text{mm}$	0	
8	Mura  (Minor)	By 2% ND filter invisible		

## 11.6.3.Others

1. Issues that are not defined in this document shall be discussed and agreed with both parties. (Customer and supplier)
2. Unless otherwise agreed upon in writing, the criteria shall be applied to both parties. (Customer and supplier)



## 12. RoHS COMPLIANT WARRANTY

RoHs Hazardous substances including:

- Cd < 100 ppm
- Pb < 1000 ppm
- Hg < 1000 ppm
- Cr +6 < 1000 ppm
- PBDE < 1000 ppm
- PBB < 1000 ppm

## 13. PRECAUTIONS FOR USE

### 13.1. Safety

- (1) Do not swallow any liquid crystal, even if there is no proof that liquid crystal is poisonous.
- (2) If the LCD panel breaks, be careful not to get liquid crystal to touch your skin.
- (3) If skin is exposed to liquid crystal, wash the area thoroughly with alcohol or soap.

### 13.2. Storage Conditions

- (1) Store the panel or module in a dark place where the temperature is  $23\pm 5^{\circ}\text{C}$  and the humidity is below  $50\pm 20\%\text{RH}$ .
- (2) Store in anti-static electricity container.
- (3) Store in clean environment, free from dust, active gas, and solvent.
- (4) Do not place the module near organics solvents or corrosive gases.
- (5) Do not crush, shake, or jolt the module.
- (6) Do not exposed to direct sun light of fluorescent lamps.

### 13.3. Installing LCD Module

Attend to the following items when installing the LCM.

- (1) Cover the surface with a transparent protective plate or touch panel to protect the polarizer and LC cell.
- (2) When assembling the LCM into other equipment, the spacer to the bit between the LCM and the fitting plate should have enough height to avoid causing stress to the module surface, refer to the individual specifications for measurements. The measurement tolerance should be  $\pm 0.1\text{mm}$ .



### 13.4.Precautions For Operation

- (1) Viewing angle varies with the change of liquid crystal driving voltage ( $V_0$ ). Adjust  $V_0$  to show the best contrast.
- (2) Driving the LCD in the voltage above the limit will shorten its lifetime.
- (3) Response time is greatly delayed at temperature below the operating temperature range. However, this does not mean the LCD will be out of the order. It will recover when it returns to the specified temperature range.
- (4) When turning the power on, input each signal after the positive/negative voltage becomes stable.
- (5) Do not apply water or any liquid on product which composed of T/P.

### 13.5.Handling Precautions

- (1) Avoid static electricity which can damage the CMOS LSI; please wear the wrist strap when handling.
- (2) The polarizing plate of the display is very fragile. so, please handle it very carefully.
- (3) Do not give external shock.
- (4) Do not apply excessive force on the surface; it may cause display abnormal .
- (5) Do not wipe the polarizing plate with a dry cloth, as it may easily scratch the surface of plate.
- (6) Do not use ketonics solvent & Aromatic solvent, use with a soft cloth soaked with a cleaning naphtha solvent.
- (7) Do not operate it above the absolute maximum rating.
- (8) Do not remove the panel or frame from the module.
- (9) Do not apply water or any liquid on product, which composed of T/P.

### 13.6.Warranty

- (1) The period is within 12 months since the date of shipping out under normal using and storage conditions.
- (2) The warranty will be avoided in case of defect induced by customer.